



DECORATIVE HARDWARE Vol.4

PROGRAM OVERVIEW

JAB
ANSTOETZ

TRAVERSING GEOMETRIC - CONCAVE



concave



W1



W1

page 2



W1 chromium

TRAVERSING GEOMETRIC - CONCAVE

CEILING

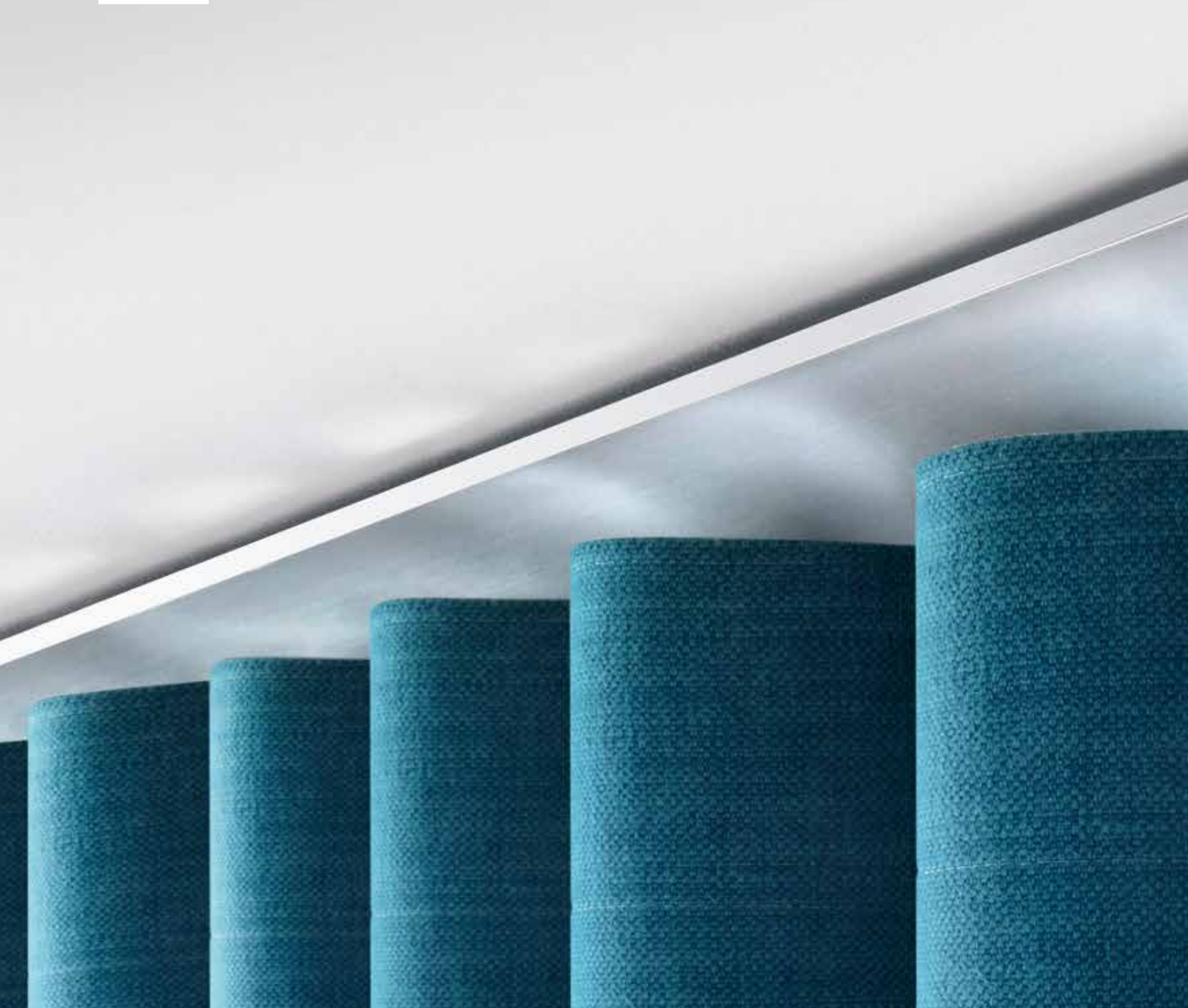

concave



W2



W2



W2 stainless steel

TRAVERSING GEOMETRIC - SQUARE



□ 5/8"



phantom 1



phantom 2



phantom 3

page 18

□ 3/4"

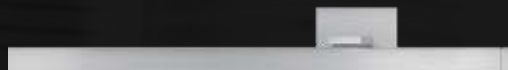

compact 3



convex 3

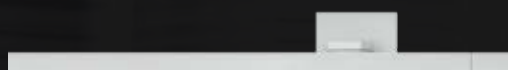

concept 3

page 38



compact 2 stainless steel

□ 3/4"



compact 1



compact 2

page 42

TRAVERSING GEOMETRIC - SQUARE

CEILING



□ 5/8"



quantum 1

page 28

□ 5/8"



cubus 1

page 32

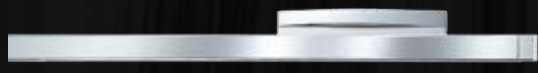

votum 1

□ 3/4"

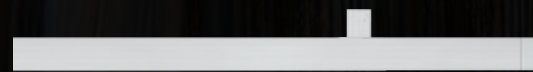

cubus 2

page 56

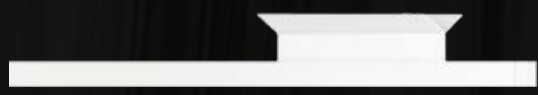

novum 1



quantum 1 chromium

□ 3/4"



quantum 2

page 52



votum 2



novum 2

TRAVERSING GEOMETRIC - FLAT



flat 1 1/8"



index 2

page 64



index 1

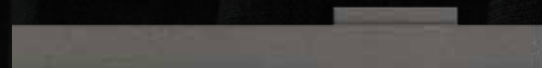

index 1

flat 1 3/8"



codex

page 80

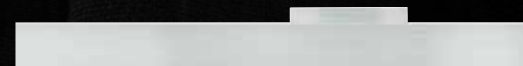

codex



dimension

page 88



vision



ambition



index 1 aluminium

flat 1³/₈"



page 98

star



cult



page 102

show



spot



event

TRAVERSING GEOMETRIC - FLAT

CEILING



flat 1¹/₈"

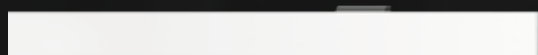

helix



helix

page 72

flat 1³/₈"

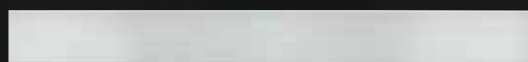

sphere

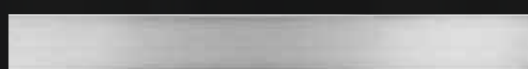

sphere

page 112



sphere stainless steel

flat 1³/₈"



cubus 35 with finial Show

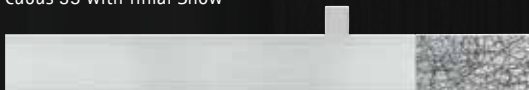

cubus 35 with finial Event

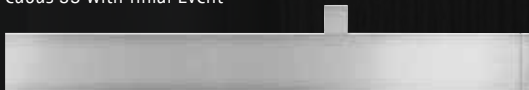

cubus 35 with finial Cult

TRAVERSING ROUND 3/4" - 7/8" dia.



3/4" dia.

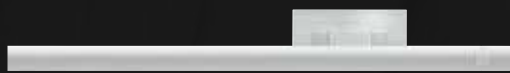

page 126

phantom 20



page 132

cosmo

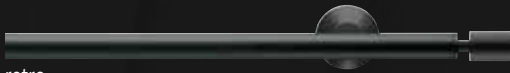

retro

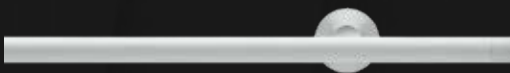

metro

3/4" dia.



page 136

duo



mono



page 146

duett



menuett



quintett



page 150

argon

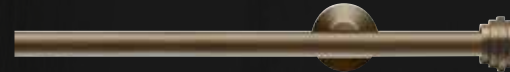

radon



xenon



lee 2 aluminium

7/8" dia.



lee 3

page 180



luv 3



log 3



lee 1

page 184



lee 2

TRAVERSING ROUND 1" - 1³/₁₆" dia.



1" dia.



phantom 25

page 210



sinus

page 216



radius



cosinus



modus

1³/₁₆" dia.



sympathy 1

page 242



sympathy 2



poetry 1

page 248



fantasy 1



poetry 2



sympathy 2 stainless steel

1³/₁₆" dia.



plenum

page 258

TRAVERSING ROUND 3/4" - 7/8" dia.

CEILING



3/4" dia.



quantum 20

page 168

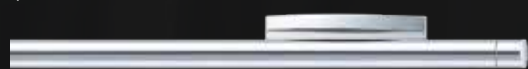

votum 20



novum 20



corpus 20

page 172

3/4" dia.



zenit 20

page 164

7/8" dia.



zenit 22

page 194



novum 22 white

7/8" dia.



quantum 22

page 198



votum 22



novum 22



corpus 22

page 202

TRAVERSING ROUND 1" - 1 3/16" dia.

CEILING



1" dia.



zenit 25

page 226

1" dia.



quantum 25

page 230



corpus 25

page 234



votum 25



corpus 25



novum 25

zenit 30 stainless steel

1³/₁₆" dia.

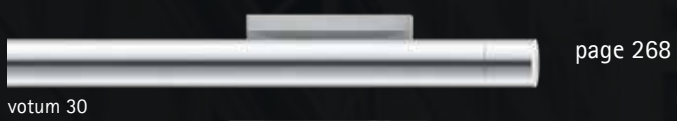

WIRE SYSTEMS



ø 2mm

techno



vario





techno aluminium

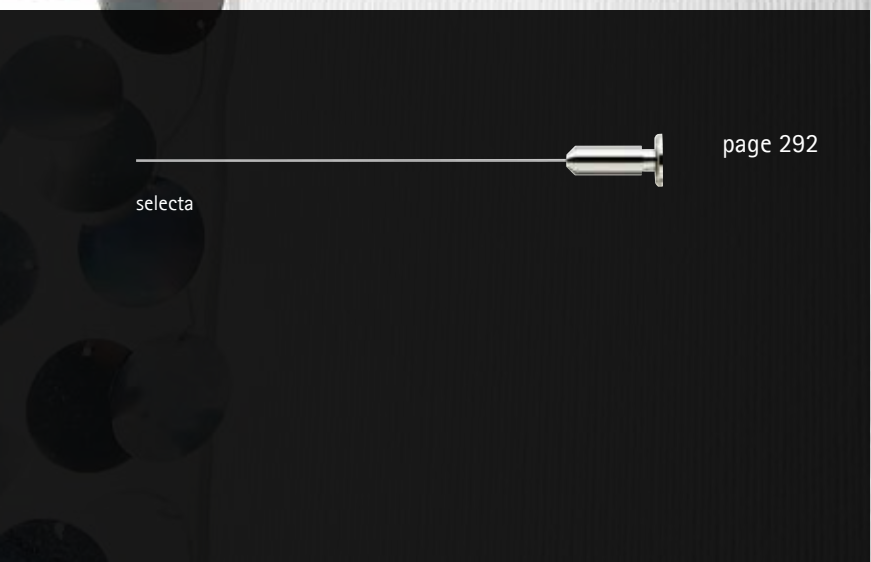

selecta

page 292

STAINLESS STEEL



5/8" dia.



barett



torero



synthese



torero-poco

page 298

3/4" dia.



double



single

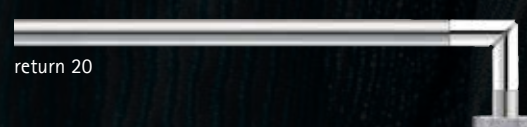

return 20

page 314

3/4" dia.



outlook .4

page 308



orbit



apollo

page 324



modul



sojus



single stainless steel

1" dia.



finale

page 334



askese



tangente

BRASS 3/4" dia.



3/4" dia.



step



atlas



akzent

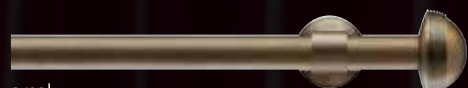

areal

page 352

3/4" dia.



solo



grazioso



legato



staccato

page 360



grazioso polished brass

$\frac{3}{4}$ " dia.



imola

page 368



iris



indigo



3/4" dia.



cosima

page 376



aida



julia

3/4" dia.



silva

page 380



hamlet

BRASS exclusive



salomo antique bronzed

1" dia.



crystal

page 398

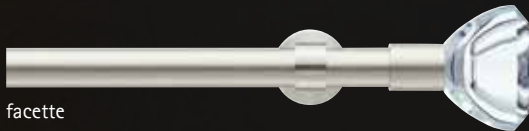

facette

1³/₁₆" dia.



salomo

page 426



saba

BRASS 1" - 1 3/8" dia.



1" dia.



polo

page 390



cup



derby

page 394



golf



globus

page 402



focus

1 3/16" dia.



empire

page 412



palace



regent



castle

page 416



turnier



empire black/polished brass

1³/₁₆" dia.



jewel

page 420



juventus



jamaica

1³/₈" dia.



prestige

page 434



odeon



ora

IRON 5/8" - 3/4" dia.



5/8" dia.



prolog

page 462



epilog



dialog



lago

page 468



toscana

5/8" dia.



casa

page 468



piazza

page 472



finca



tivoli



piazza anthracite

3/4" dia.



olivia

page 478



hellas



athos

IRON 3/4" - 1" dia.



3/4" dia.



fox

page 482

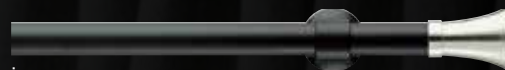

jazz



akzent



legato



staccato

3/4" dia.



ergo

page 488



riva

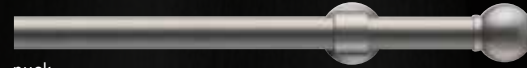

puck



basis



wimbledon black

1" dia.



hampton

page 496



madison



kensington

page 500



lexington



wimbledon

WOOD



1³/₁₆" dia.



delft



davos

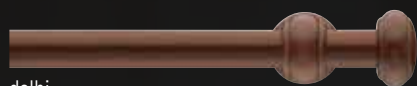

delhi

page 512

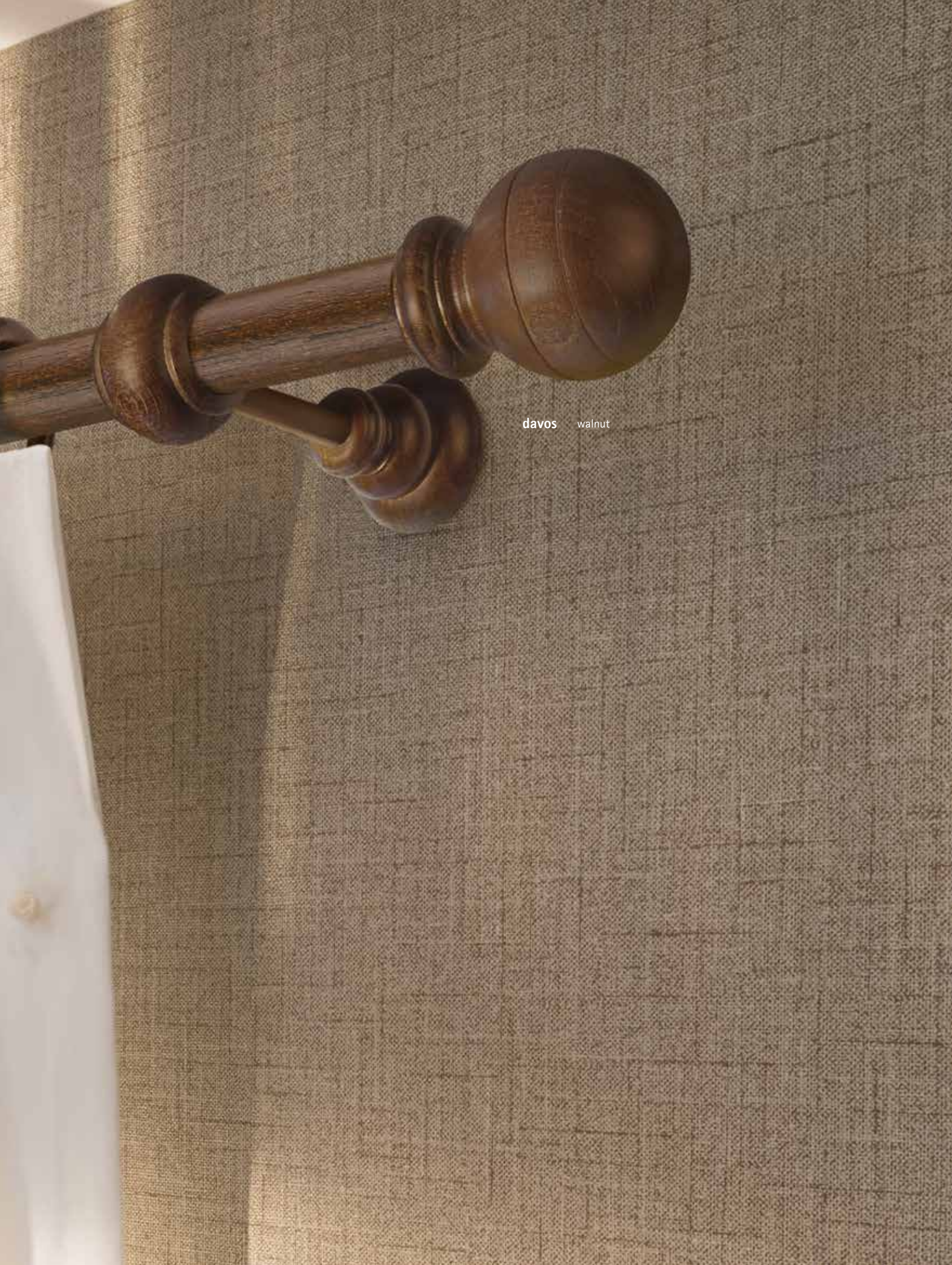

davos walnut

HOLDBACKS



for traversing systems
page 276



for stainless steel
page 342



for brass
page 444



for iron
page 505



TIEBACKS



for traversing systems
page 278

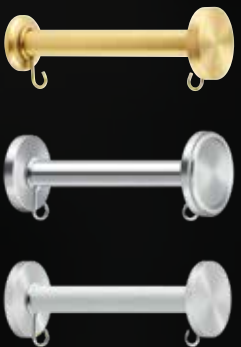

for stainless steel
page 342



for brass
page 448

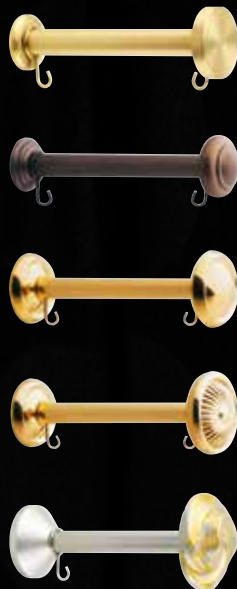

for iron
page 506



for wood
page 518



BATONS



for traversing systems
page 275

for stainless steel
page 341

for brass
page 443



RIPPLEFOLD

FOR TRAVERSING SYSTEMS



see following pages



RIPPLEFOLD

FOR TRAVERSING SYSTEMS

(except PLENUM 13/16")

- 100% fullness
- Easy snap-on carriers for convenient installation and uninstallation.
- Choice of white or transparent tape.

HOW TO WORK

- fixed spacing between carriers of 2 1/8"
- each ripplefold drape has an even number of carriers
- for center draw (split drapes) calculate coverage of each panel individually

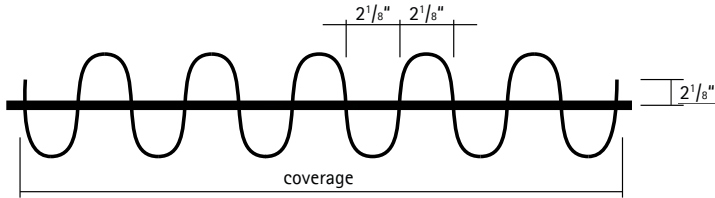

single draw

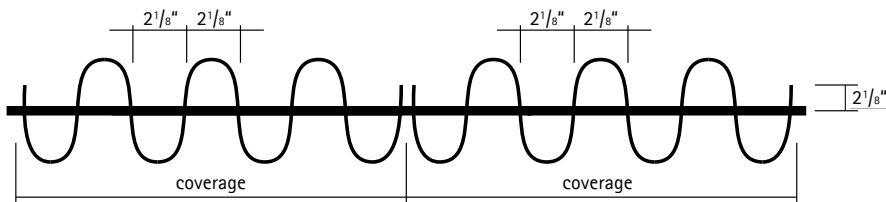

center draw

components

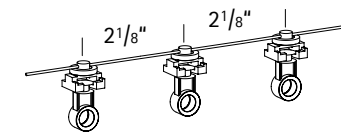

part

part-no. color-no.

price

carriers with cord
spacing between
carriers 2 1/8"
with easy snap
for convenient installation

40 pcs
60 pcs
80 pcs
100 pcs
120 pcs

29085/40 50
29085/60 50
29085/80 50
29085/100 50
29085/120 50

white
white
white
white
white

52.00
78.00
104.00
130.00
156.00

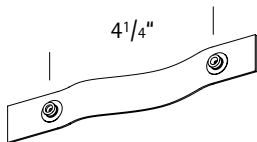

ripplefold tape
spacing between
buttons 4 1/4"
100 % fullness
spool 100 yards

29012

50

white
transparent

413.60
413.60

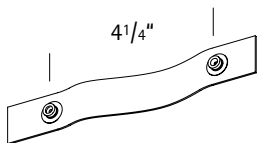

ripplefold tape
spacing between
buttons 4 1/4"
100 % fullness
cut to measure

29010

50

white
transparent

per lin. ft. 1.70
per lin. ft. 1.70

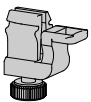

brake
to control the rebound forces of the
corrugated curtain
infinitely adjustable

33089

50

white

3.40



stop clamp

30089

50

white

1.80

sewing instruction

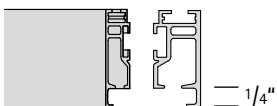

Traversing rods with concealed track:
Reduce header by 1/4"

RIPPLEFOLD

FABRICATION CHART

coverage	carriers	hemmed width
inches (up to)	No. of	length of tape in inches
15	8	34
19	10	42 1/2
23 1/2	12	51
27 1/2	14	59 1/2
32	16	68
36	18	76 1/2
40 1/2	20	85
44 1/2	22	93 1/2
49	24	102
53	26	110 1/2
57 1/2	28	119
61 1/2	30	127 1/2
66	32	136
70	34	144 1/2
74 1/2	36	153
78 1/2	38	161 1/2
83	40	170
87	42	178 1/2
91 1/2	44	187
95 1/2	46	195 1/2
100	48	204
104	50	212 1/2
108 1/2	52	221
112 1/2	54	229 1/2
117	56	238
121	58	246 1/2
125 1/2	60	255
129 1/2	62	263 1/2
134	64	272
138	66	280 1/2
142 1/2	68	289
146 1/2	70	297 1/2
151	72	306
155	74	314 1/2
159 1/2	76	323
163 1/2	78	331 1/2
168	80	340
172	82	348 1/2
176 1/2	84	357
180 1/2	86	365 1/2
185	88	374
189	90	382 1/2
193 1/2	92	391
197 1/2	94	399 1/2
202	96	408
206	98	416 1/2
210 1/2	100	425
214 1/2	102	433 1/2
219	104	442

FINISHES

metal finishes round



16 - carbon



50 - white



51 - anthracite



56 - black



60 - polished brass



61 - antique brass



62 - brushed brass



68 - silver



70 - chromium



71 - polished nickel



72 - brushed nickel



74 - iron



77 - stainless steel



79 - aluminium



80 - antique bronzed



81 - rust

metal finishes flat

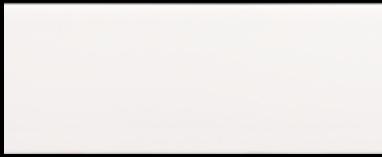

50 - white



51 - anthracite

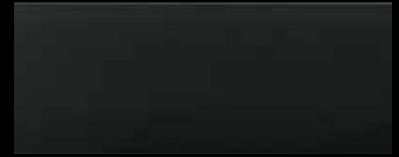

56 - black



62 - brushed brass



70 - chromium



72 - brushed nickel



77 - stainless steel



79 - aluminium



80 - antique bronzed

wood finishes



21 - walnut



23 - light oak



25 - cherry



28 - wengé



40 - genuine beech



43 - genuine oak



46 - genuine maple



50 - white

style index

set	page	set	page	set	page	set	page
A		F		N		Step	452
Aida	154	Facette	398	Novum 1	28	Swing	154
Aida	376	Fantasy 1	248	Novum 2	52	Swing	482
Akzent	154	Finale	334	Novum 20	168	Sympathy 1	242
Akzent	482	Finca	472	Novum 22	198	Sympathy 2	242
Akzent	603	Focus	402	Novum 25	230	Synthese	298
Ambition	88	Fox	154	Novum 30	268	T	
Apollo	324	Fox	482	O		Tangente	334
Areal	154	G		Odeon	434	Techno	298
Areal	352	Globus	402	Olivia	478	Tivoli	472
Areal	482	Golf	394	Ora	434	Torero	298
Argon	150	Grazioso	360	Orbit	324	Torero-poco	298
Askese	324	Grazioso	482	Outlook	308	Toscana	468
Athos	478	H		P		Turnier	416
Atlas	154	Hamlet	380	Palace	412	V	
Atlas	352	Hampton	496	Phantom 1	18	Vario	292
Atlas	482	Helix	72	Phantom 2	18	Vision	88
B		Hellas	478	Phantom 20	126	Votum 1	52
Barett	298	I		Phantom 25	210	Votum 2	37
Basis	488	Imola	154	Phantom 3	18	Votum 20	168
C		Imola	368	Piazza	488	Votum 22	198
Casa	468	Index 1	64	Plenum	258	Votum 25	230
Castle	416	Index 2	64	Poetry 1	248	Votum 30	268
Codex	80	Indigo	154	Poetry 2	248	W	
Compact 1	42	Indigo	368	Polo	390	W1	2
Compact 2	42	Iris	154	Prestige	434	W2	10
Compact 3	38	Iris	368	Prolog	482	Wimbledon	500
Concept 3	38	J		Puck	488	X	
Convex 3	38	Jamaica	420	Q		Xenon	150
Corpus 20	172	Jazz	154	Quantum 1	28	Z	
Corpus 22	202	Jazz	482	Quantum 2	52	Zenit 20	164
Corpus 25	234	Jewel	420	Quantum 20	168	Zenit 22	194
Corpus 30	268	Julia	154	Quantum 22	198	Zenit 25	226
Cosima	154	Julia	376	Quantum 25	230	Zenit 30	264
Cosima	376	Juventus	420	Quintett	146	R	
Cosinus	216	K		Radius	216	Radon	150
Cosmo	132	Kensington	500	Regent	412	Retro	132
Crystal	398	L		Return 20	314	Riva	488
Cubus 1	32	Lee 1	184	S		Saba	426
Cubus 2	56	Lee 2	184	Saba	426	Salomo	426
Cubus 35	120	Lee 3	180	Salomo	292	Selecta	292
Cult	98	Lago	468	Show	102	Single	314
Cup	390	Legato	360	Silva	380	Sinus	216
D		Legato	482	Single	314	Solo	360
Davos	512	Lexington	500	Sinus	216	Solo	360
Delft	512	Log 3	180	Sojus	324	Sojus	324
Delhi	512	Luv 3	180	Sphere	112	Sphere	112
Derby	394	M		Spot	102	Spot	102
Dialog	462	Madison	496	Staccato	360	Staccato	360
Dimension	88	Match	390	Staccato	482	Star	98
Double	314	Menuett	146	Star	98		
Duett	146	Metro	132				
Duo	136	Modul	324				
E		Modus	216				
Empire	412	Mono	136				
Epilog	462						
Ergo	488						
Event	102						

notes

Surfaces and Care

- JAB hardware surfaces are manufactured with the highest care and attention to detail. Our highly automated production ensures uniform quality for all of our finished products. While uncommon, slight inconsistencies may appear. If these should occur and cannot be detected from a distance of 3 feet then there is no grounds for a claim.
- JAB hardware products are designed exclusively for indoor use. If used in areas where the air contains high levels of salt or chlorine, this can damage the sealant coating on the surfaces of the product. If this occurs there is no cause for a claim.
- Chromium and Polished Nickel finishes are acceptable to be used in rooms with high moisture content (i.e the bathroom). JAB hardware products should only be cleaned with a slightly damp cloth and not with abrasive or solvent based cleaning products, as this may damage the finish.
- Over time accumulation of dust on the poles can affect the smooth sliding of the curtain rings. We recommend the top of the poles be cleaned regularly with a damp cloth. If you choose you may apply a thin layer of silicone based lubricant to the rod to improve sliding and reduce any noise.
- A silicon based lubricant is applied in the factory on traversing systems. We recommend applying a silicon based lubricant at the time of installation as well as from time to time.

Brackets and Fastenings

- The figure given in the pricing table for brackets is a guideline only and is based on the understanding that:
 - The brackets are assembled and installed at equal distances
 - The pole extends approximately 6 inches beyond the outer brackets to the right and left
 - Gathered curtains always hang under a bracket
 - Light to moderately heavy fabrics are used
 - For heavier materials with wider widths and higher room heights the number of brackets must be increased and if necessary a larger pole diameter must be selected.
- Consult with your installer if additional brackets are required based on your job site conditions
- JAB includes universal dowels which can be used to fasten the product in tiles and plasterboard walls. It is the responsibility of the installer to test and ensure the right dowel is being used for the installation.

Deliveries

- For systems larger than 9 feet, the item will be delivered in two or more pieces depending on the overall length of the rod.
- All hardware purchases are final and not returnable.

terms and conditions

- All orders must be in writing, signed and emailed or faxed to our Customer Service Department
Email: hardware@jab.us Fax: 718-361-0159
- The prices in this binder are suggested retail prices, FOB North Carolina. All prices are subject to change without notice. All orders are subject to shipping and handling charges.
- ALL orders must be inspected upon receipt.
- Claims for any damages must be addressed within 30 days of shipping.
- Damaged merchandise must be authorized before returning
- ALL our hardware products are not returnable.

traversing
geometric



concave

W1 chromium



finishes available

70 chromium

77 stainless steel

79 aluminium



wv1 77 stainless steel



wv1 70 chromium





traversing geometric concave

finishes available

- A 79 aluminium
- B 77 stainless steel
- C 70 chromium

material: aluminium

single rod

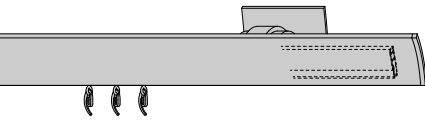

length → | 13/16"



Set-No.

freestanding

03310

wall socket left side

03311

wall socket right side

03312

wall to wall

03313

length (ft.)	rollers	brackets		bracket 3 3/4"			bracket 6"			ripplefold surcharge	
				A	B	C	A	B	C		
3	16	2	\$	587	671	822	619	707	866	61	
4	20	2		624	713	876	656	749	920	58	
5	24	2		661	755	931	692	791	975	54	
6	30	2		699	798	987	731	834	1031	50	
7	34	3		910	1041	1286	958	1095	1352	87	
8	40	3		949	1084	1342	996	1139	1408	82	
9	44	3		986	1126	1397	1033	1181	1463	79	
10	50	3		1024	1169	1453	1071	1224	1519	74	
11	54	3		1061	1211	1508	1108	1266	1574	107	
12	60	3		1099	1255	1564	1147	1309	1630	102	
13	64	4		1310	1497	1863	1374	1570	1951	99	
14	68	4		1347	1539	1917	1410	1612	2005	136	
15	74	4		1386	1583	1974	1449	1656	2062	131	
16	78	4		1422	1625	2028	1486	1697	2116	128	
17	84	4		1461	1668	2084	1524	1741	2172	123	
18	88	4		1498	1710	2139	1561	1783	2227	148	
reduction per wall socket					180	214	270	196	232	292	

Notes

- rods in excess of 9ft. will be delivered in two sections
- rod with ending on both sides cannot be shortened

traversing geometric concave



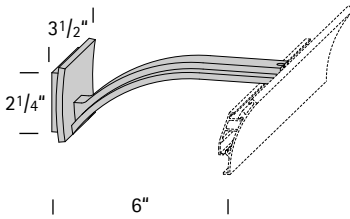
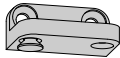
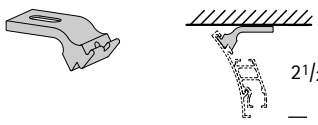
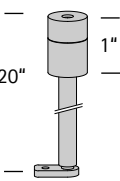
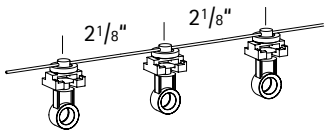

components	part	part-no.	color-no.	price
	traversing rod W1 concave 2 1/4" material: aluminium freestanding with ending 1 3/16" both sides cannot be shortened use end caps 33778 and 33779 to close track at both ends	33770	70 chromium	51.40 +145.00
			77 stainless steel	38.70 +119.40
			79 aluminium	33.60 +103.60
	traversing rod W1 concave 2 1/4" material: aluminium with ending 1 3/16" right side for wall socket left side use end cap 33778 to close track at right end side	33771	70 chromium	51.40 +72.50
			77 stainless steel	38.70 +59.70
			79 aluminium	33.60 +51.80
	traversing rod W1 concave 2 1/4" material: aluminium with ending 1 3/16" left side for wall socket right side use end cap 33779 to close track at left end side	33772	70 chromium	51.40 +72.50
			77 stainless steel	38.70 +59.70
			79 aluminium	33.60 +51.80
	traversing rod W1 concave 2 1/4" material: aluminium for wall sockets at both sides	33773	70 chromium	51.40
			77 stainless steel	38.70
			79 aluminium	33.60
	endcap to close track at ending right	33778	70 chromium	8.80
			77 stainless steel	8.80
			79 aluminium	8.80
	left 33779	33779		
	bracket 3 3/4" cannot be shortened	33711	70 chromium	244.30
			77 stainless steel	200.60
			79 aluminium	174.40

traversing geometric concave

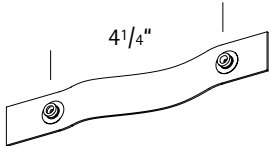
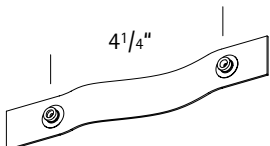

components	part	part-no.	color-no.	price		
	bracket 6" cannot be shortened	33712	70	chromium	266.30	
			77	stainless steel	218.80	
			79	aluminium	190.20	
	bracket for larger wall clearances	on request				
	wall socket for hidden mount can be used at both ends	33705	50	white	55.20	
	ceiling bracket for hidden mount shadow gap 1/6"	33718	50	white	51.30	
	bracket 20" can be shortened	21615	70	chromium	119.40	
			77	stainless steel	107.40	
			79	aluminium	93.40	
	carriers with cord spacing between carriers 2 1/8" with easy snap for convenient installation	40 pcs	29085/40	50	white	52.00
		60 pcs	29085/60	50	white	78.00
		80 pcs	29085/80	50	white	104.00
		100 pcs	29085/100	50	white	130.00
		120 pcs	29085/120	50	white	156.00

traversing geometric concave

components

	part	part-no.	color-no.	price	
	ripplefold tape spacing between buttons 4 1/4" 100 % fullness spool 100 yards	29012	50	white	413.60
			11	transparent	413.60
	ripplefold tape spacing between buttons 4 1/4" 100 % fullness cut to measure	29010	50	white	per lin. ft. 1.70
			11	transparent	per lin. ft. 1.70
	roller with eyelet	30082	50	white	0.80
	curtain hook	30080	50	white	0.20
	runner for batons can be retrofitted	30078	50	white	3.60
	stop clamp	30089	50	white	1.80

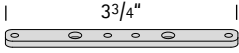
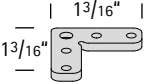
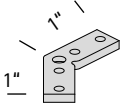
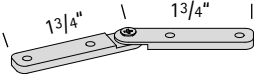
traversing geometric concave

components	part	part-no.	color-no.	price
	connector	30579	99	16.90
	corner connector 90° mitre cut \$ 43.00	30550	99	25.90
	corner connector 135° mitre cut \$ 43.00	30551	99	30.40
	corner connector flexible mitre cut \$ 43.00	30552	99	59.70
	batons	see page 275		



traversing
geometric

concave

ceiling

W2 stainless steel

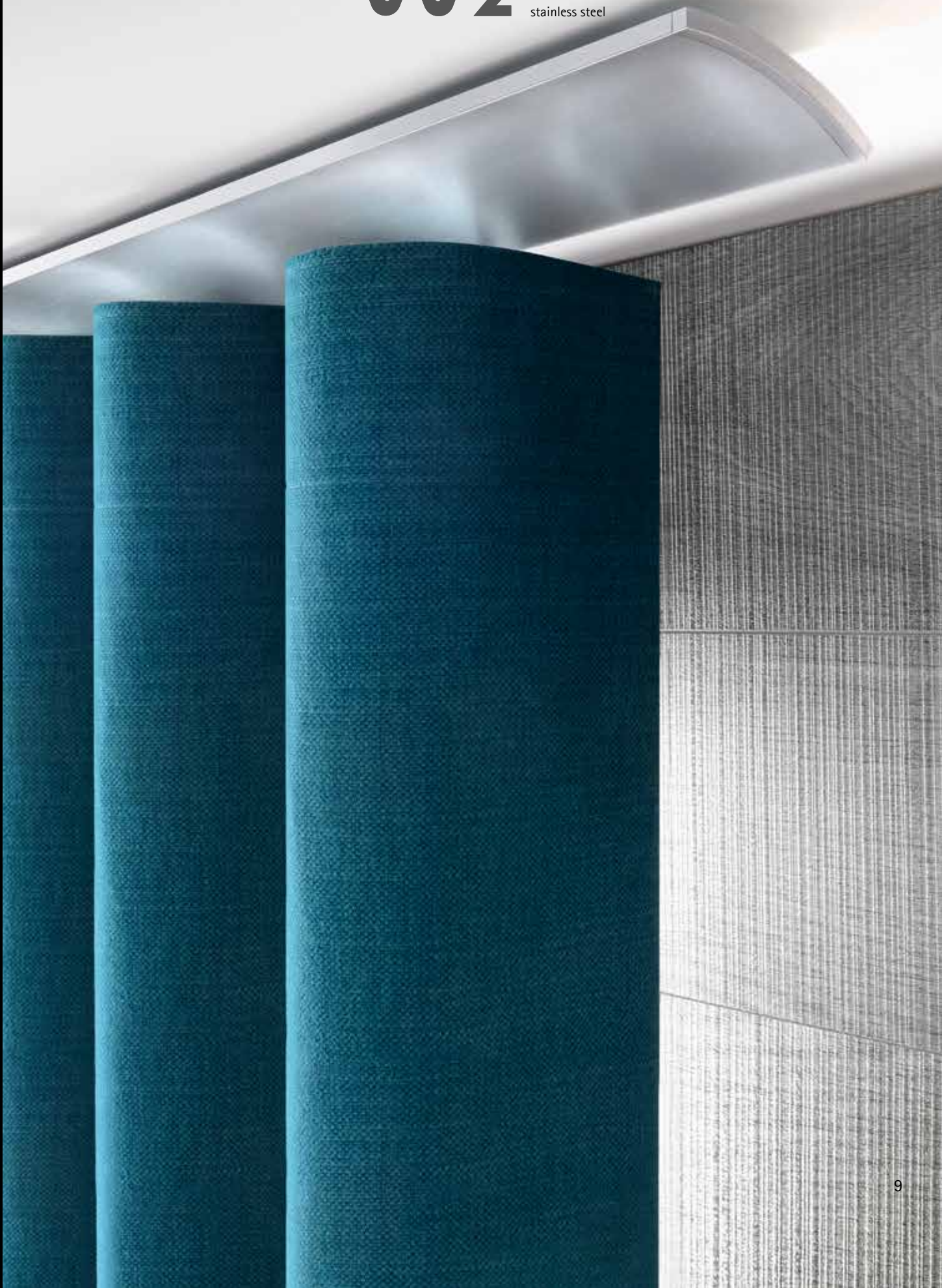

50 white 70 chromium 77 stainless steel 79 aluminium



W2 79 aluminium



W2 70 chromium



W2 50 white



traversing geometric concave

finishes available

- A 50 white
- 79 aluminium
- B 77 stainless steel
- C 70 chromium

material: aluminium

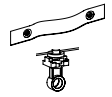
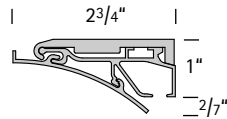

single rod

length rollers brackets

ripplefold

(ft.)				A	B	C	surcharge
3	16	2	\$	355	387	450	61
4	20	2		392	428	505	58
5	24	3		488	529	618	54
6	30	3		526	572	674	50
7	34	3		563	614	729	87
8	40	3		601	658	785	82
9	44	4		696	758	898	79
10	50	4		735	802	954	74
11	54	4		772	844	1009	107
12	60	4		810	887	1065	102
13	64	4		847	929	1120	99
14	68	5		942	1029	1233	136
15	74	5		981	1073	1289	131
16	78	5		1017	1115	1344	128
17	84	5		1056	1158	1400	123
18	88	5		1093	1200	1454	148
			reduction per wall socket	61	69	81	

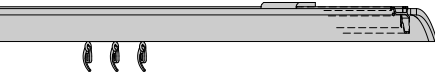

length → | 1 3/16"

W2

Set-No.

freestanding 03320

wall contact left side 03321



wall contact right side 03322

wall to wall 03323

Notes

- rods in excess of 9ft. will be delivered in two sections
- rod with ending on both sides cannot be shortened

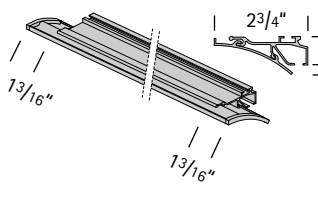
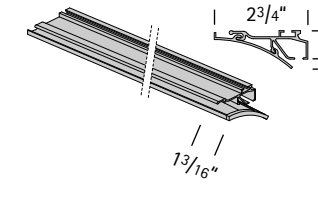
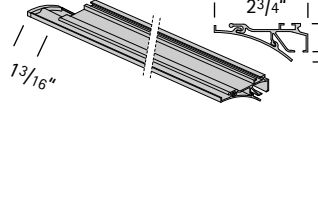
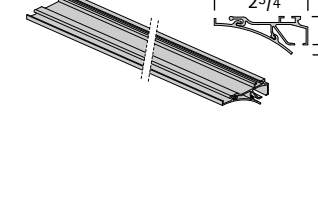
traversing geometric concave

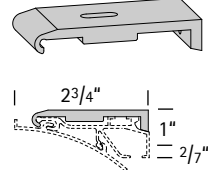
components	part	part-no.	color-no.	price
	traversing rod W2 concave material: aluminium freestanding with ending 1 ³ / ₁₆ " both sides cannot be shortened use end caps 33878 and 33879 to close track at both ends	33870	50 white	33.60 +103.60
			70 chromium	51.40 +145.00
			77 stainless steel	38.70 +119.40
			79 aluminium	33.60 +103.60
			<small>Cut to measure \$/ lin. ft.</small>	
	traversing rod W2 concave material: aluminium with ending 1 ³ / ₁₆ " right side for wall contact left side use with end cap 33878 to close track at right end side	33871	50 white	33.60 +51.80
			70 chromium	51.40 +72.50
			77 stainless steel	38.70 +59.70
			79 aluminium	33.60 +51.80
			<small>Cut to measure \$/ lin. ft.</small>	
	traversing rod W2 concave material: aluminium with ending 1 ³ / ₁₆ " left side for wall contact right side use with end cap 33879 to close track at left end side	33872	50 white	33.60 +51.80
			70 chromium	51.40 +72.50
			77 stainless steel	38.70 +59.70
			79 aluminium	33.60 +51.80
			<small>Cut to measure \$/ lin. ft.</small>	
	traversing rod W2 concave material: aluminium for wall contact at both sides	33873	50 white	33.60 +51.80
			70 chromium	51.40 +72.50
			77 stainless steel	38.70 +59.70
			79 aluminium	33.60 +51.80
			<small>Cut to measure \$/ lin. ft.</small>	
	endcap to close track at ending	right	33878	50 white 8.80
				70 chromium 8.80
				77 stainless steel 8.80
				79 aluminium 8.80
		left	33879	
	ceiling bracket for hidden mount shadow gap 1/5"	33815	56 black	58.90

traversing geometric concave

components

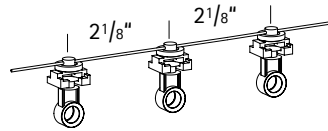

part	part-no.	color-no.	price
carriers with cord	40 pcs 29085/40	50 white	52.00
spacing between carriers 2 1/8"	60 pcs 29085/60	50 white	78.00
	80 pcs 29085/80	50 white	104.00
	100 pcs 29085/100	50 white	130.00
with easy snap for convenient installation	120 pcs 29085/120	50 white	156.00

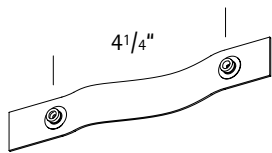

ripplefold tape	29012	50 white	413.60
spacing between buttons 4 1/4"		11 transparent	413.60
100 % fullness			
spool 100 yards			

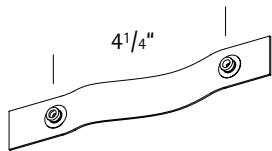

ripplefold tape	29010	50 white	per lin. ft. 1.70
spacing between buttons 4 1/4"		11 transparent	per lin. ft. 1.70
100 % fullness			
cut to measure			



roller	30082	50 white	0.80
with eyelet			





curtain hook	30080	50 white	0.20
---------------------	-------	----------	------

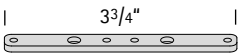
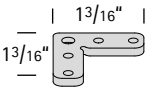
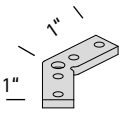
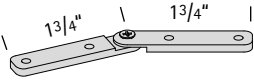

runner for batons	30078	50 white	3.60
can be retrofitted			

traversing geometric concave

components	part	part-no.	color-no.	price
	stop clamp	30089	50 white	1.80
	connector	30579	99	16.90
	corner connector 90° mitre cut \$ 43.00	30550	99	25.90
	corner connector 135° mitre cut \$ 43.00	30551	99	30.40
	corner connector flexible mitre cut \$ 43.00	30552	99	59.70
	batons	see page 275		

square 5/8"

traversing
geometric

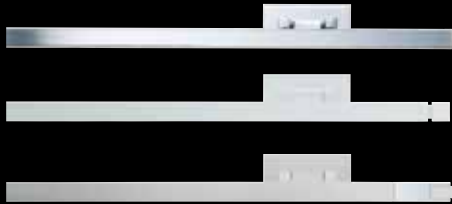



phantom 2 aluminium



phantom 3 chromium/wengé



phantom 1 stainless steel



finishes available



70 chromium

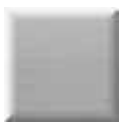

77 stainless steel



79 aluminium

phantom 1 70 chromium



phantom 2 79 aluminium



phantom 3 77/78 stainless steel/polished aluminium



scale 1:1

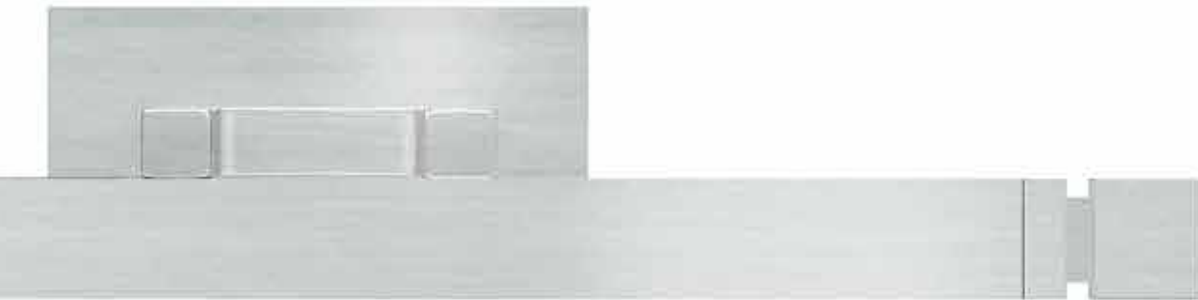
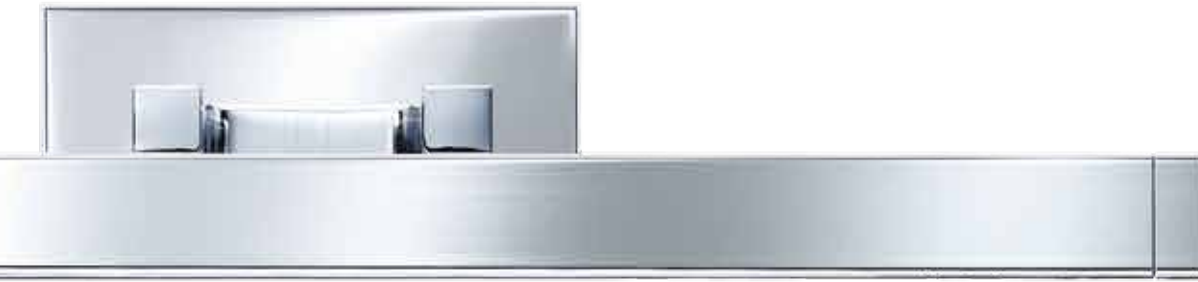

finial phantom 3



28 wengé



78 polished aluminium

traversing geometric square 5/8"

finishes available

- A 79 aluminium
- B 77 stainless steel
- C 70 chromium

material: aluminium

single rod

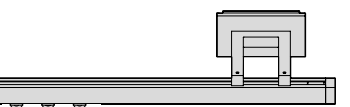

length \rightarrow $\frac{3}{8}$ "

set-no.
Phantom 1 01590

length rollers brackets

(ft.)

3	16	2	\$
4	20	3	
5	24	3	
6	30	3	
7	34	3	
8	40	4	
9	44	4	
• 10	50	4	
11	54	4	
12	60	5	
13	64	5	
14	68	5	
15	74	5	
16	78	6	
17	84	6	
18	88	6	
reduction per wall socket			



bracket 3"

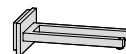

bracket 5"

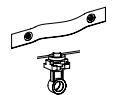

ripplefold

surcharge

			bracket 3"			bracket 5"			
			A	B	C	A	B	C	
			444	540	679	493	590	749	61
			614	743	930	688	820	1034	58
			635	770	971	709	846	1075	54
			657	797	1013	731	874	1117	50
			677	824	1054	751	900	1158	87
			849	1029	1306	947	1131	1445	82
			869	1055	1347	968	1157	1486	79
			891	1083	1390	990	1185	1528	74
			911	1109	1431	1010	1211	1569	107
			1083	1315	1683	1207	1442	1856	102
			1104	1341	1724	1227	1468	1897	99
			1124	1367	1764	1247	1494	1938	136
			1146	1395	1807	1269	1522	1980	131
			1316	1599	2057	1464	1751	2266	128
			1338	1626	2100	1486	1779	2308	123
			1358	1653	2141	1507	1805	2349	148
			132	162	201	156	187	235	

double rod

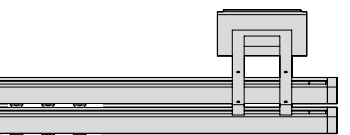

length \rightarrow $\frac{3}{8}$ "

set-no.
Phantom 1 01593

length rollers brackets

(ft.)

3	32	2	\$
4	40	3	
5	48	3	
6	60	3	
7	68	3	
8	80	4	
9	88	4	
• 10	100	4	
11	108	4	
12	120	5	
13	128	5	
14	136	5	
15	148	5	
16	156	6	
17	168	6	
18	176	6	
reduction per wall socket			

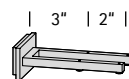

bracket 3"

			bracket 3"		
			A	B	C
			663	804	1038
			891	1074	1379
			932	1127	1461
			976	1182	1546
			1016	1235	1627
			1247	1508	1971
			1288	1560	2053
			1332	1616	2138
			1373	1668	2220
			1604	1942	2564
			1645	1994	2646
			1685	2047	2727
			1729	2102	2812
			1957	2372	3153
			2001	2428	3238
			2042	2480	3320
			151	186	241

Notes

- rods in excess of 9ft. will be delivered in two sections



accessories see page 276

traversing geometric square 5/8"

finishes available

- A 79 aluminium
- B 77 stainless steel
- C 70 chromium

material: aluminium

single rod

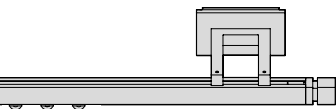

length → 1"

set-no.
Phantom 2 01591

length (ft.)	rollers	brackets		bracket 3"			bracket 5"			ripplefold surcharge	
				A	B	C	A	B	C		
3	16	2	\$	498	598	745	547	649	814	61	
4	20	3		668	802	995	742	878	1099	58	
5	24	3		689	828	1036	763	904	1140	54	
6	30	3		711	856	1078	785	932	1183	50	
7	34	3		731	882	1119	805	958	1223	87	
8	40	4		903	1088	1371	1001	1189	1510	82	
9	44	4		923	1114	1412	1022	1215	1551	79	
• 10	50	4		945	1142	1455	1044	1243	1594	74	
11	54	4		965	1168	1496	1064	1269	1635	107	
12	60	5		1137	1373	1748	1261	1500	1921	102	
13	64	5		1158	1399	1789	1281	1526	1962	99	
14	68	5		1178	1426	1830	1301	1553	2003	136	
15	74	5		1200	1453	1872	1323	1580	2046	131	
16	78	6		1370	1657	2123	1518	1810	2331	128	
17	84	6		1392	1685	2165	1540	1837	2373	123	
18	88	6		1412	1711	2206	1561	1864	2414	148	
reduction per wall socket					159	191	233	183	217	268	

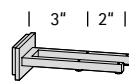

double rod

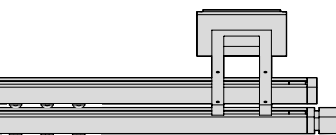

length → 1"

set-no.
Phantom 2 01594

length (ft.)	rollers	brackets		bracket 3"			
				A	B	C	
3	32	2	\$	717	863	1103	
4	40	3		945	1133	1444	
5	48	3		986	1185	1526	
6	60	3		1030	1241	1611	
7	68	3		1070	1293	1693	
8	80	4		1301	1567	2036	
9	88	4		1342	1619	2118	
• 10	100	4		1386	1675	2203	
11	108	4		1427	1727	2285	
12	120	5		1658	2000	2629	
13	128	5		1699	2053	2711	
14	136	5		1739	2105	2793	
15	148	5		1783	2161	2878	
16	156	6		2011	2431	3218	
17	168	6		2055	2486	3303	
18	176	6		2096	2539	3385	
reduction per wall socket					178	215	274

Notes

- rods in excess of 9ft. will be delivered in two sections



accessories see page 276

traversing geometric square 5/8"

finishes available

material: aluminium, finials with wood

- A 79/28 aluminium/wengé
79/78 aluminium/polished aluminium
- B 77/28 stainless steel/wengé
77/78 stainless steel/polished aluminium
- C 70/28 chromium/wengé

single rod

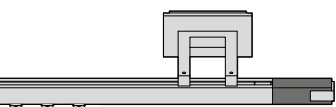

length $\rightarrow 2\frac{1}{16}"$

set-no. **Phantom 3** 01592

length rollers brackets



bracket 3"



bracket 5"

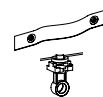

ripplefold

(ft.)				bracket 3"			bracket 5"			surcharge
				A	B	C	A	B	C	
3	16	2	\$	525	625	751	574	676	821	61
4	20	3		695	829	1002	769	905	1106	58
5	24	3		716	855	1043	790	931	1147	54
6	30	3		738	883	1085	812	959	1189	50
7	34	3		758	909	1126	832	985	1230	87
8	40	4		930	1115	1378	1028	1216	1517	82
9	44	4		950	1141	1419	1049	1242	1558	79
10	50	4		972	1169	1462	1071	1270	1600	74
11	54	4		992	1195	1503	1091	1296	1641	107
12	60	5		1164	1400	1755	1288	1527	1928	102
13	64	5		1185	1426	1796	1308	1553	1969	99
14	68	5		1205	1453	1836	1328	1580	2010	136
15	74	5		1227	1480	1879	1350	1607	2052	131
16	78	6		1397	1684	2129	1545	1837	2338	128
17	84	6		1419	1712	2172	1567	1864	2380	123
18	88	6		1439	1738	2213	1588	1891	2421	148
reduction per wall socket				172	205	237	197	230	271	

double rod

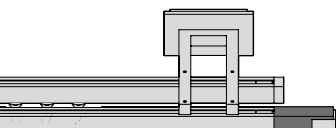

length $\rightarrow 2\frac{1}{16}"$

set-no. **Phantom 3** 01595

length rollers brackets

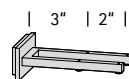

bracket 3"

(ft.)				bracket 3"		
				A	B	C
3	32	2	\$	744	890	1110
4	40	3		972	1160	1451
5	48	3		1013	1212	1533
6	60	3		1057	1268	1618
7	68	3		1097	1320	1699
8	80	4		1328	1594	2043
9	88	4		1369	1646	2125
10	100	4		1413	1702	2210
11	108	4		1454	1754	2292
12	120	5		1685	2027	2636
13	128	5		1726	2080	2718
14	136	5		1766	2132	2799
15	148	5		1810	2188	2884
16	156	6		2038	2458	3225
17	168	6		2082	2513	3310
18	176	6		2123	2566	3392
reduction per wall socket				191	229	277



Notes

- rods in excess of 9ft. will be delivered in two sections







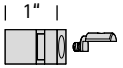
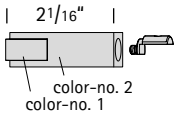
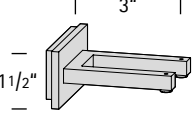
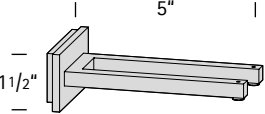
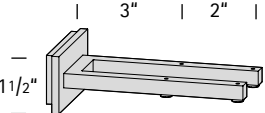
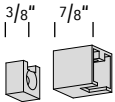
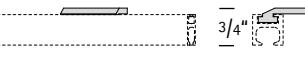
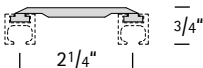

accessories see page 276

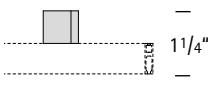
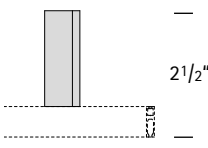

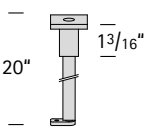
traversing geometric square 5/8"

components	part	part-no.	color-no.	price
	traversing rod 5/8" x 5/8" square material: aluminium	17970	70 chromium 77 stainless steel 79 aluminium	Cut to measure \$/ lin. ft. 37.70 23.00 17.20
	end cap Phantom 1	17929	70 chromium 77 stainless steel 79 aluminium	65.30 49.50 38.30
	finial Phantom 2	17901	70 chromium 77 stainless steel 79 aluminium	97.90 78.80 65.30
	finial Phantom 3	17902	70/28 chromium/wengé 77/28 stainless steel/wengé 77/78 stainless steel/pol. aluminium 79/28 aluminium/wengé 79/78 aluminium/polished aluminium	101.30 92.30 92.30 78.80 78.80
	bracket 3" Phantom	21711	70 chromium 77 stainless steel 79 aluminium	209.60 177.60 149.70
	bracket 5" Phantom	21712	70 chromium 77 stainless steel 79 aluminium	244.30 203.00 174.40
	double bracket 3" Phantom	21721	70 chromium 77 stainless steel 79 aluminium	258.90 217.70 186.90
	wall socket can be used at both ends	17905	70 chromium 77 stainless steel 79 aluminium	74.30 65.30 56.30
	ceiling bracket close to ceiling shadow gap 1/8"	30514	50 white 79 aluminium	20.00 20.00
	ceiling bracket close to ceiling for double rod shadow gap 1/8"	30524	50 white 79 aluminium	33.30 33.30

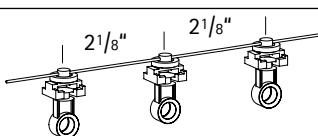
traversing geometric square 5/8"

components	part	part-no.	color-no.	price		
	ceiling bracket 3/4" square	17914	70	chromium	101.30	
			77	stainless steel	85.50	
			79	aluminium	74.30	
	ceiling bracket 2" square	17916	70	chromium	120.40	
			77	stainless steel	103.50	
			79	aluminium	88.90	
	extension piece 3/4" for brackets 17914, 17916	17917	70	chromium	44.60	
			77	stainless steel	38.30	
			79	aluminium	33.80	
	ceiling bracket 20" can be shortened square	21715	70	chromium	258.90	
			77	stainless steel	198.10	
			79	aluminium	165.40	
	roller with eyelet	30082	50	white	0.80	
	curtain hook	30080	50	white	0.20	
	runner for batons can be retrofitted	30078	50	white	3.60	
	stop clamp	30089	50	white	1.80	
	carriers with cord spacing between carriers 2 1/8" with easy snap for convenient installation	40 pcs	29085/40	50	white	52.00
		60 pcs	29085/60	50	white	78.00
		80 pcs	29085/80	50	white	104.00
		100 pcs	29085/100	50	white	130.00
		120 pcs	29085/120	50	white	156.00

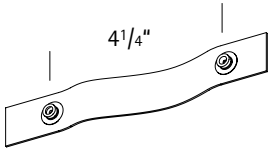
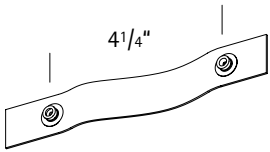
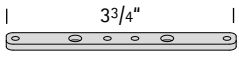
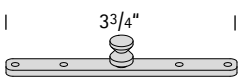
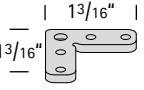
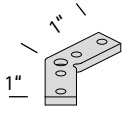
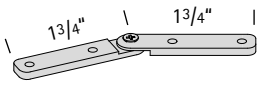
traversing geometric square 5/8"

components	part	part-no.	color-no.	price
	ripplefold tape spacing between buttons 4 1/4" 100 % fullness spool 100 yards	29012	50 11 white transparent	413.60 413.60
	ripplefold tape spacing between buttons 4 1/4" 100 % fullness cut to measure	29010	50 11 white transparent	per lin. ft. 1.70 per lin. ft. 1.70
	connector for bracket Phantom	30579	99	16.90
	connector for brackets 17914, 17916	30577	99	16.90
	connector for brackets 30514, 30524 (plastic)	21719	99	13.50
	corner connector 90° mitre cut \$ 43.00	30550	99	25.90
	corner connector 135° mitre cut \$ 43.00	30551	99	30.40
	corner connector flexible mitre cut \$ 43.00	30552	99	59.70
	batons	see page 275		

page 28

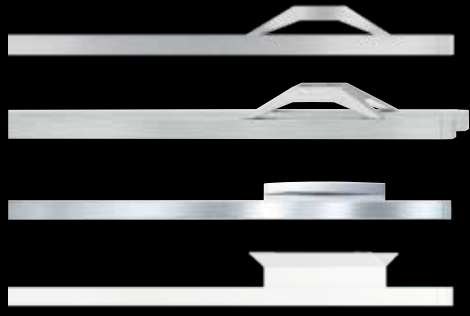

page 32

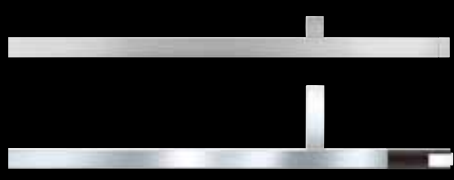

traversing
geometric

square 5/8"

ceiling

traversing geometric square 5/8"

quantum 1 chromium

finishes available



50 white
(Novum only)



70 chromium

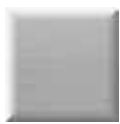

77 stainless steel



79 aluminium



quantum 1 77 stainless steel



quantum 1 79 aluminium



votum 1 70 chromium



novum 1 50 white

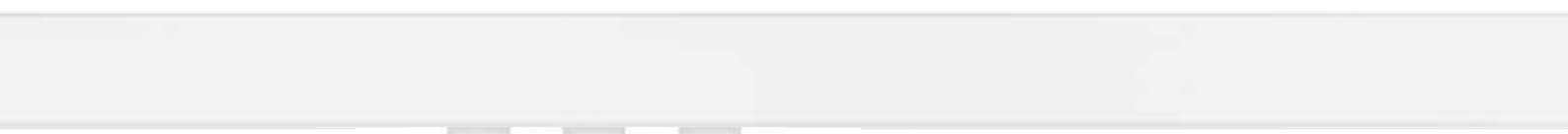

scale 1:1

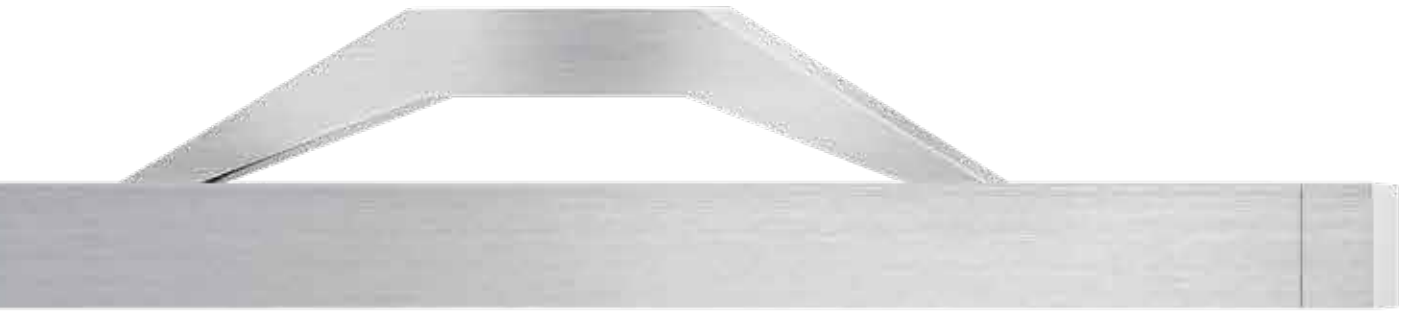

traversing geometric square 5/8"

finishes available

material: aluminium

- A 79 aluminium
- B 77 stainless steel
- C 70 chromium (single rod only)

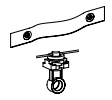

single rod

length (ft.)	rollers	brackets		1 1/2"			surcharge
				A	B	C	
3	16	2	\$	352	413	510	61
4	20	3		514	602	741	58
5	24	3		535	629	782	54
6	30	3		557	656	824	50
7	34	4		719	846	1056	87
8	40	4		741	874	1098	82
9	44	4		761	900	1139	79
• 10	50	5		925	1092	1372	74
11	54	5		946	1118	1413	107
12	60	5		968	1146	1455	102
13	64	6		1130	1335	1686	99
set-no. 14	68	6		1150	1362	1727	136
15	74	6		1172	1389	1770	131
Quantum 1 01596 16	78	6		1193	1416	1810	128
17	84	7		1357	1607	2043	123
18	88	7		1377	1633	2084	148

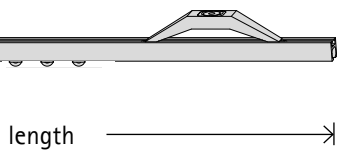

length →

set-no.

Quantum 1 01596

set without
finials

finials see
page 34



double rod

length (ft.)	rollers	brackets		1 1/2"	
				A	B
3	32	2	\$	494	583
4	40	3		714	841
5	48	3		754	893
6	60	3		798	949
7	68	4		1018	1207
8	80	4		1062	1263
9	88	4		1103	1315
• 10	100	5		1326	1577
11	108	5		1367	1629
12	120	5		1411	1685
13	128	6		1630	1943
set-no. 14	136	6		1671	1995
15	148	6		1715	2051
Quantum 1 01597 16	156	6		1756	2103
17	168	7		1979	2365
18	176	7		2020	2417

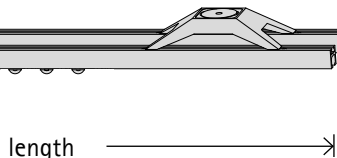

length →

set-no.

Quantum 1 01597

set without
finials (on both rods)

finials see
page 34



Notes

- rods in excess of 9ft. will be delivered in two sections



accessories see page 276

traversing geometric square 5/8"

finishes available

material: aluminium

- A 79 aluminium
50 white (Novum only)
- B 77 stainless steel
- C 70 chromium

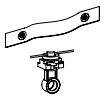

single rod

length rollers brackets  1 1/4"

ripplefold

(ft.)				A	B	C	surcharge
3	16	2	\$	289	340	420	61
4	20	3		420	493	606	58
5	24	3		440	519	647	54
6	30	3		462	547	689	50
7	34	4		593	701	876	87
8	40	4		615	728	918	82
9	44	4		635	755	959	79
• 10	50	5		768	910	1147	74
11	54	5		788	936	1188	107
12	60	5		810	964	1230	102
13	64	6		941	1117	1416	99
14	68	6		961	1143	1457	136
15	74	6		983	1171	1500	131
16	78	6		1004	1197	1540	128
17	84	7		1136	1352	1728	123
18	88	7		1156	1378	1769	148

length →

set-no.

Votum 1 01598

set without
finials

finials see
page 34



single rod

length rollers brackets  1 7/8"

ripplefold

(ft.)				A	B	C	surcharge
3	16	2	\$	352	413	510	61
4	20	3		514	602	741	58
5	24	3		535	629	782	54
6	30	3		557	656	824	50
7	34	4		719	846	1056	87
8	40	4		741	874	1098	82
9	44	4		761	900	1139	79
• 10	50	5		925	1092	1372	74
11	54	5		946	1118	1413	107
12	60	5		968	1146	1455	102
13	64	6		1130	1335	1686	99
14	68	6		1150	1362	1727	136
15	74	6		1172	1389	1770	131
16	78	6		1193	1416	1810	128
17	84	7		1357	1607	2043	123
18	88	7		1377	1633	2084	148

length →

set-no.

Novum 1 01579

set without
finials

finials see
page 34



Notes

- rods in excess of 9ft. will be delivered in two sections



accessories see page 276

components see page 34

finishes available



50 white



70 chromium



77 stainless steel



79 aluminium

cubus 1 77 stainless steel
with finial Phantom 1



cubus 1 70 chromium
with finial Phantom 3



scale 1:1

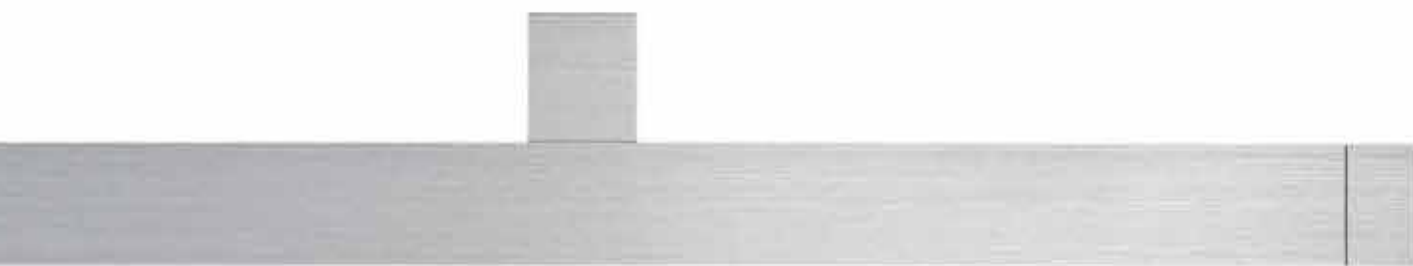

traversing geometric square 5/8"

finishes available

- A 50 white
- 79 aluminium
- B 77 stainless steel
- C 70 chromium

material: aluminium

single rod



length →

set-no.

Cubus 1 01599

set without
finials

finials see below

length rollers brackets

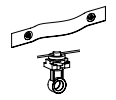
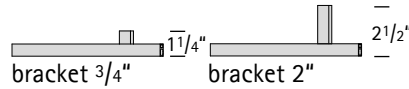

ripplefold

(ft.)				bracket 3/4"	bracket 2"					
				A	B	C	A	B	C	surcharge
3	16	2	\$	217	256	332	246	292	370	61
4	20	3		311	368	474	355	422	532	58
5	24	3		332	394	515	376	448	573	54
6	30	3		354	422	558	398	476	615	50
7	34	4		448	534	700	507	606	776	87
8	40	4		470	562	742	529	634	819	82
9	44	4		491	588	783	549	660	860	79
10	50	5		587	701	927	660	791	1023	74
11	54	5		608	727	968	681	817	1064	107
12	60	5		630	755	1011	703	845	1106	102
13	64	6		724	867	1153	812	975	1267	99
14	68	6		745	893	1194	832	1001	1308	136
15	74	6		767	921	1236	854	1029	1351	131
16	78	6		787	947	1277	875	1055	1392	128
17	84	7		883	1060	1421	986	1186	1555	123
18	88	7		904	1087	1462	1006	1213	1595	148

components

part

part-no. color-no.

price

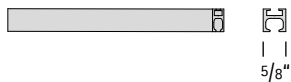

traversing rod 5/8" x 5/8"
square
material: aluminium

17970

50 white
70 chromium
77 stainless steel
79 aluminium

Cut to measure
\$/ lin. ft. 17.20
37.70
23.00
17.20



end cap
Phantom 1

17929

50 white
70 chromium
77 stainless steel
79 aluminium

38.30
65.30
49.50
38.30

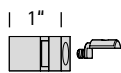

finial
Phantom 2

17901

70 chromium
77 stainless steel
79 aluminium

97.90
78.80
65.30

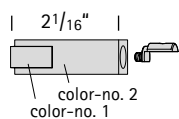

finial
Phantom 3

17902

70/28 chromium/wengé
77/28 stainless steel/wengé
77/78 stainless steel/pol. aluminium
79/28 aluminium/wengé
79/78 aluminium/polished aluminium

101.30
92.30
92.30
78.80
78.80

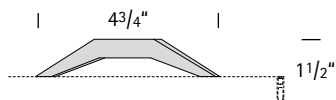

ceiling bracket
Quantum
single rod

21716

70 chromium
77 stainless steel
79 aluminium

190.20
163.60
141.90

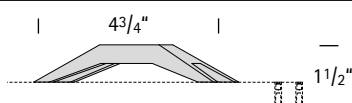

ceiling bracket
Quantum
double rod
distance between rods 2"

21726

77 stainless steel
79 aluminium

205.90
178.90

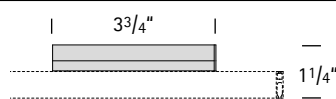







ceiling bracket
Votum

21714

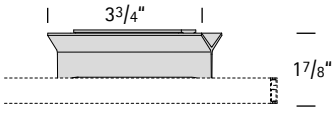
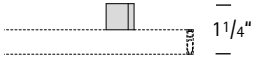
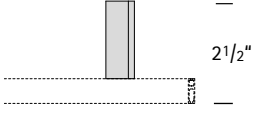

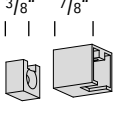
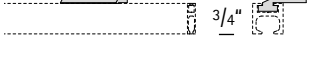
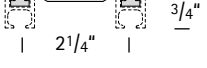
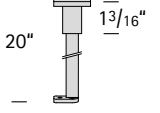
70 chromium
77 stainless steel
79 aluminium

145.20
127.20
110.40

traversing geometric square 5/8"

components	part	part-no.	color-no.	price
	ceiling bracket Novum	22815	50 white 70 chromium 77 stainless steel 79 aluminium	141.90 190.20 163.60 141.90
	ceiling bracket Cubus 3/4" square	17914	50 white 70 chromium 77 stainless steel 79 aluminium	74.30 101.30 85.50 74.30
	ceiling bracket Cubus 2" square	17916	50 white 70 chromium 77 stainless steel 79 aluminium	88.90 120.40 103.50 88.90
	extension piece 3/4" for brackets 17914, 17916	17917	50 white 70 chromium 77 stainless steel 79 aluminium	33.80 44.60 38.30 33.80
	wall socket can be used at both ends	17905	50 white 70 chromium 77 stainless steel 79 aluminium	56.30 74.30 65.30 56.30
	ceiling bracket close to ceiling shadow gap 1/8"	30514	50 white 79 aluminium	20.00 20.00
	ceiling bracket close to ceiling for double rod shadow gap 1/8"	30524	50 white 79 aluminium	33.30 33.30
	ceiling bracket 20", can be shortened square	21715	50 white 70 chromium 77 stainless steel 79 aluminium 80 antique bronzed	165.40 258.90 198.10 165.40 198.10
	roller with eyelet	30082	50 white	0.80
	curtain hook	30080	50 white	0.20
	runner for batons can be retrofitted	30078	50 white	3.60

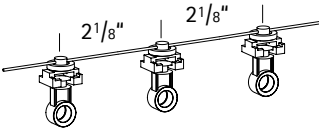
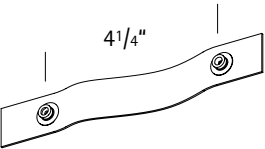
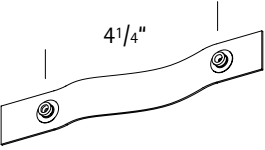
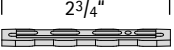
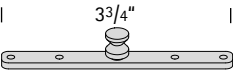
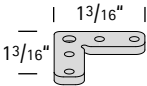
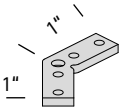
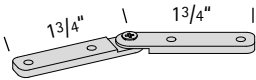
traversing geometric square 5/8"

components	part	part-no.	color-no.	price	
	stop clamp	30089	50 white	1.80	
	carriers with cord spacing between carriers 2 1/8" with easy snap for convenient installation	40 pcs 60 pcs 80 pcs 100 pcs 120 pcs	29085/40 29085/60 29085/80 29085/100 29085/120	50 white 50 white 50 white 50 white 50 white	52.00 78.00 104.00 130.00 156.00
	ripplefold tape spacing between buttons 4 1/4" 100 % fullness spool 100 yards	29012	50 white 11 transparent	413.60 413.60	
	ripplefold tape spacing between buttons 4 1/4" 100 % fullness cut to measure	29010	50 white 11 transparent	per lin. ft. 1.70 per lin. ft. 1.70	
	connector for brackets Quantum, Votum, Novum and 30514, 30524 (plastic)	21719	99	13.50	
	connector for ceiling bracket Cubus	30577	99	16.90	
	corner connector 90° mitre cut \$ 43.00	30550	99	25.90	
	corner connector 135° mitre cut \$ 43.00	30551	99	30.40	
	corner connector flexible mitre cut \$ 43.00	30552	99	59.70	
	batons	see page 275			

price list 2018

page 38



page 42



traversing
geometric

square 3/4"

convex 1 chromium

compact 2 stainless steel

concept 3 aluminium



finishes available

50 white 51 anthracite 70 chromium 72 brushed nickel 77 stainless steel 79 aluminium

compact 3 77 stainless steel



convex 3 70 chromium



concept 3 79 aluminium

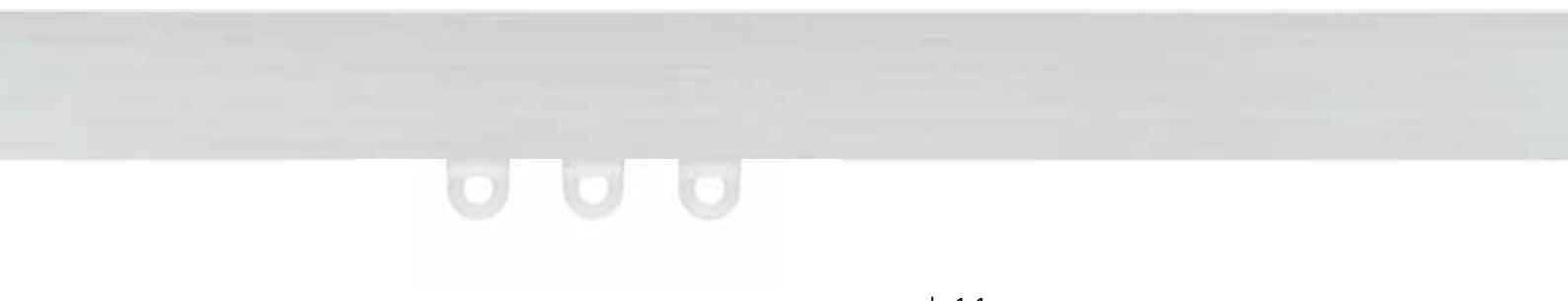

scale 1:1



traversing geometric square 3/4"

finishes available

material: aluminium

- A 50 white
- 51 anthracite
- 79 aluminium
- B 72 brushed nickel
- 77 stainless steel
- C 70 chromium

single rod

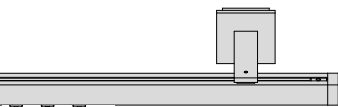

length → | 3/8"

set-no.

Compact 3 02107

length (ft.)	rollers	brackets		bracket 3"			bracket 5"			bracket 7"			ripplefold surcharge
				A	B	C	A	B	C	A	B	C	
3	16	2	\$	421	501	641	443	526	672	466	555	703	61
4	20	2		444	529	687	466	554	718	489	584	748	58
5	24	2		467	558	733	489	582	763	512	612	794	54
6	30	3		624	742	962	658	779	1008	692	823	1054	50
7	34	3		647	770	1008	681	807	1054	715	851	1100	87
8	40	3		672	800	1055	706	837	1101	740	881	1147	82
9	44	3		695	828	1101	729	865	1147	763	909	1193	79
10	50	3		720	858	1148	753	895	1194	787	939	1240	74
11	54	4		876	1040	1376	921	1090	1438	966	1148	1499	107
12	60	4		900	1070	1424	945	1119	1485	990	1178	1546	102
13	64	4		924	1098	1469	968	1148	1531	1014	1206	1592	99
14	68	4		947	1126	1515	991	1176	1576	1037	1235	1637	136
15	74	4		971	1156	1562	1016	1206	1624	1061	1264	1685	131
16	78	4		994	1184	1608	1039	1234	1669	1084	1293	1730	128
17	84	5		1152	1368	1838	1208	1430	1914	1264	1504	1991	123
18	88	5		1175	1396	1883	1231	1458	1960	1288	1532	2036	148
reduction per wall socket				114	138	170	125	150	185	136	165	201	

double rod

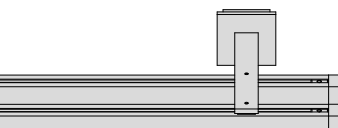

length → | 3/8"

set-no.

Compact 3 02116

length (ft.)	rollers	brackets		bracket 3"			bracket 5"		
				A	B	C	A	B	C
3	32	2	\$	629	758	991	652	785	1022
4	40	2		676	814	1083	698	841	1113
5	48	2		722	871	1174	744	897	1205
6	60	3		931	1117	1488	965	1157	1534
7	68	3		977	1173	1579	1011	1213	1625
8	80	3		1027	1233	1674	1061	1273	1720
9	88	3		1073	1289	1765	1107	1329	1811
10	100	3		1122	1349	1860	1156	1389	1906
11	108	4		1328	1591	2170	1373	1644	2231
12	120	4		1378	1651	2265	1423	1704	2326
13	128	4		1424	1707	2356	1469	1760	2417
14	136	4		1470	1764	2448	1515	1817	2509
15	148	4		1519	1823	2542	1565	1876	2603
16	156	4		1566	1880	2634	1611	1933	2695
17	168	5		1775	2125	2947	1831	2192	3024
18	176	5		1821	2182	3039	1878	2248	3115
reduction per wall socket				122	153	194	133	166	210

Notes

- rods in excess of 9ft. will be delivered in two sections



accessories see page 276

traversing geometric square 3/4"

finishes available

material: aluminium

- A 50 white
- 51 anthracite
- 79 aluminium
- B 72 brushed nickel
- 77 stainless steel
- C 70 chromium

single rod



length → 1"

- set-no.
- Concept 3** 02108
- Convex 3** 02109

length (ft.)	rollers	brackets	\$	bracket 3"			bracket 5"			bracket 7"			ripplefold surcharge
				A	B	C	A	B	C	A	B	C	
3	16	2		517	600	743	540	625	773	562	654	804	61
4	20	2		540	628	788	563	653	819	585	683	850	58
5	24	2		564	657	834	586	681	865	609	711	895	54
6	30	3		721	841	1064	755	878	1110	789	922	1156	50
7	34	3		744	869	1109	778	906	1155	812	950	1201	87
8	40	3		769	899	1157	802	936	1203	836	980	1249	82
9	44	3		792	927	1202	826	964	1248	859	1008	1294	79
• 10	50	3		817	957	1250	850	994	1296	884	1038	1342	74
11	54	4		973	1139	1478	1017	1189	1539	1063	1247	1600	107
12	60	4		997	1169	1525	1042	1218	1586	1087	1277	1647	102
13	64	4		1020	1197	1571	1065	1247	1632	1110	1305	1693	99
14	68	4		1043	1225	1616	1088	1275	1678	1133	1334	1739	136
15	74	4		1068	1255	1664	1113	1305	1725	1158	1363	1786	131
16	78	4		1091	1283	1709	1136	1333	1771	1181	1392	1832	128
17	84	5		1249	1467	1939	1305	1529	2016	1361	1603	2092	123
18	88	5		1272	1495	1985	1328	1557	2061	1384	1631	2138	148
reduction per wall socket				162	187	221	173	200	236	185	214	251	

double rod



length → 1"

- set-no.
- Concept 3** 02117
- Convex 3** 02120

length (ft.)	rollers	brackets	\$	bracket 3"			bracket 5"		
				A	B	C	A	B	C
3	32	2		726	857	1093	749	884	1123
4	40	2		772	913	1184	795	940	1215
5	48	2		819	970	1276	841	996	1306
6	60	3		1028	1216	1589	1062	1256	1635
7	68	3		1074	1272	1681	1108	1312	1727
8	80	3		1123	1332	1775	1157	1372	1821
9	88	3		1170	1388	1867	1204	1428	1913
• 10	100	3		1219	1448	1961	1253	1488	2007
11	108	4		1425	1690	2272	1470	1743	2333
12	120	4		1474	1750	2366	1520	1803	2427
13	128	4		1521	1806	2458	1566	1859	2519
14	136	4		1567	1863	2549	1612	1916	2610
15	148	4		1616	1922	2644	1661	1975	2705
16	156	4		1662	1979	2735	1708	2032	2796
17	168	5		1872	2224	3049	1928	2291	3125
18	176	5		1918	2281	3140	1974	2347	3217
reduction per wall socket				170	203	245	181	216	260

Notes

- rods in excess of 9ft. will be delivered in two sections

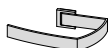

accessories see page 276

finishes available



50 white

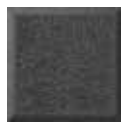

51 anthracite



70 chromium



72 brushed nickel



77 stainless steel



79 aluminium

50 white

51 anthracite
(flat brackets only)

70 chromium

72 brushed nickel

77 stainless steel

79 aluminium

compact 1 70 chromium



compact 2 77 stainless steel



scale 1:1



traversing geometric square 3/4"

finishes available

- A 79 aluminium
- B 72 brushed nickel
- 77 stainless steel

material: aluminium

single rod

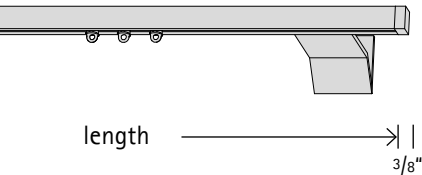

length \rightarrow | $\frac{3}{8}$ "



set-no.
 **Compact 2** 02133

length (ft.)	rollers	brackets		bracket 3 ³ / ₄ "		bracket 6"		ripplefold surcharge
				A	B	A	B	
3	16	2	\$	556	639	592	675	61
4	20	2		579	667	615	703	58
5	24	2		602	695	638	731	54
6	30	3		827	948	881	1002	50
7	34	3		850	976	904	1030	87
8	40	3		875	1006	929	1060	82
9	44	3		898	1034	952	1088	79
• 10	50	3		923	1064	977	1118	74
11	54	4		1146	1315	1218	1387	107
12	60	4		1171	1345	1243	1417	102
13	64	4		1194	1373	1266	1445	99
14	68	4		1217	1401	1289	1473	136
15	74	4		1242	1431	1314	1503	131
16	78	4		1265	1459	1337	1531	128
17	84	5		1490	1712	1580	1802	123
18	88	5		1513	1740	1603	1830	148
reduction per wall socket				181	206	199	224	

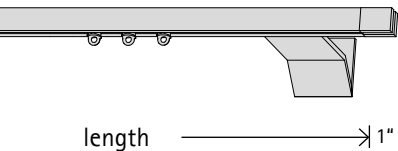
single rod



length \rightarrow | 1 "

set-no.
 **Concept 2** 02134
 **Convex 2** 02135

length (ft.)	rollers	brackets		bracket 3 ³ / ₄ "		bracket 6"		ripplefold surcharge
				A	B	A	B	
3	16	2	\$	653	738	689	774	61
4	20	2		676	766	712	802	58
5	24	2		699	794	735	830	54
6	30	3		924	1047	978	1101	50
7	34	3		947	1075	1001	1129	87
8	40	3		972	1105	1026	1159	82
9	44	3		995	1133	1049	1187	79
• 10	50	3		1019	1163	1073	1217	74
11	54	4		1243	1414	1315	1486	107
12	60	4		1268	1444	1340	1516	102
13	64	4		1291	1472	1363	1544	99
14	68	4		1314	1500	1386	1572	136
15	74	4		1339	1530	1411	1602	131
16	78	4		1362	1558	1434	1630	128
17	84	5		1587	1811	1677	1901	123
18	88	5		1610	1839	1700	1929	148
reduction per wall socket				230	256	248	274	

Notes

- rods in excess of 9ft. will be delivered in two sections



accessories see page 276

traversing geometric square 3/4"

finishes available

material: aluminium

- A 50 white
51 anthracite
79 aluminium
- B 72 brushed nickel
77 stainless steel
- C 70 chromium

single rod

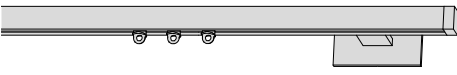

set-no.
Compact 1 02129

length (ft.)	rollers	brackets		bracket 3"			bracket 5"			bracket 7"			ripplefold surcharge
				A	B	C	A	B	C	A	B	C	
3	16	2	\$	454	537	687	477	563	723	499	589	759	61
4	20	2		477	565	732	500	591	768	522	617	804	58
5	24	2		501	594	778	523	619	814	546	645	850	54
6	30	3		675	796	1030	709	834	1084	742	873	1138	50
7	34	3		698	824	1076	732	863	1130	766	902	1184	87
8	40	3		723	854	1123	756	892	1177	790	931	1231	82
9	44	3		746	882	1169	779	921	1223	813	960	1277	79
• 10	50	3		771	912	1216	804	950	1270	838	989	1324	74
11	54	4		943	1112	1467	988	1164	1539	1033	1216	1611	107
12	60	4		968	1142	1514	1013	1193	1586	1058	1245	1658	102
13	64	4		991	1170	1560	1036	1222	1632	1081	1274	1704	99
14	68	4		1014	1198	1605	1059	1250	1677	1104	1302	1749	136
15	74	4		1039	1228	1653	1084	1280	1725	1129	1332	1797	131
16	78	4		1062	1256	1698	1107	1308	1770	1152	1360	1842	128
17	84	5		1236	1458	1951	1292	1523	2041	1349	1588	2131	123
18	88	5		1260	1486	1996	1316	1551	2086	1372	1616	2176	148
reduction per wall socket				131	156	193	142	169	211	153	182	229	

single rod

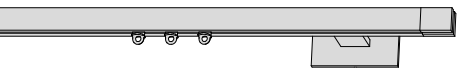

set-no.
Concept 1 02130
Convex 1 02132

length (ft.)	rollers	brackets		bracket 3"			bracket 5"			bracket 7"			ripplefold surcharge
				A	B	C	A	B	C	A	B	C	
3	16	2	\$	551	636	788	574	662	824	596	688	860	61
4	20	2		574	664	834	597	690	870	619	716	906	58
5	24	2		597	693	879	620	718	915	642	744	951	54
6	30	3		772	895	1132	805	933	1186	839	972	1240	50
7	34	3		795	923	1177	828	962	1231	862	1001	1285	87
8	40	3		820	953	1225	853	991	1279	887	1030	1333	82
9	44	3		843	981	1270	876	1020	1324	910	1059	1378	79
• 10	50	3		867	1011	1318	901	1049	1372	935	1088	1426	74
11	54	4		1040	1211	1568	1085	1263	1640	1130	1315	1712	107
12	60	4		1065	1241	1615	1110	1292	1687	1155	1344	1759	102
13	64	4		1088	1269	1661	1133	1321	1733	1178	1373	1805	99
14	68	4		1111	1297	1707	1156	1349	1779	1201	1401	1851	136
15	74	4		1136	1327	1754	1181	1379	1826	1226	1431	1898	131
16	78	4		1159	1355	1800	1204	1407	1872	1249	1459	1944	128
17	84	5		1333	1557	2052	1389	1622	2142	1446	1687	2232	123
18	88	5		1356	1585	2098	1412	1650	2188	1469	1715	2278	148
reduction per wall socket				179	205	243	190	218	261	202	231	279	

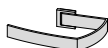

Notes

- rods in excess of 9ft. will be delivered in two sections



accessories see page 276



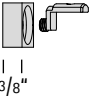
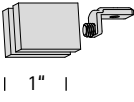
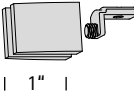
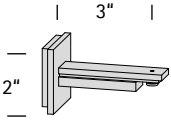
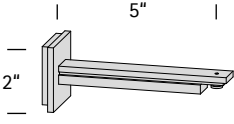
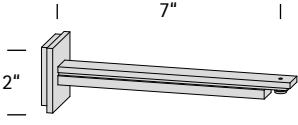
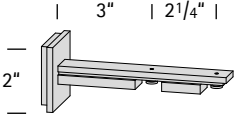

traversing geometric square 3/4"

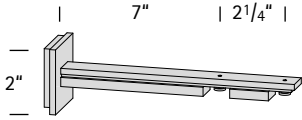
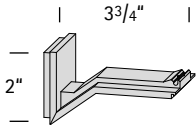
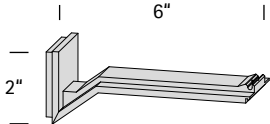
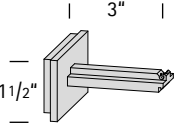
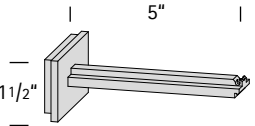
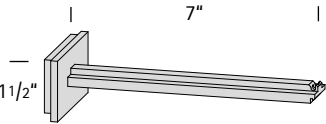
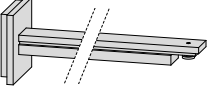
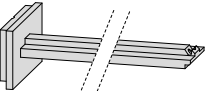
components	part	part-no.	color-no.	price	
 	traversing rod 3/4" x 3/4" square material: aluminium	22870	50 white	<small>Cut to measure \$ / lin. ft.</small> 19.90	
			51 anthracite		19.90
			70 chromium		42.50
			72 brushed nickel		25.00
			77 stainless steel		25.00
			79 aluminium		19.90
	end cap Compact	22829	50 white	39.40	
			51 anthracite	39.40	
			70 chromium	66.40	
			72 brushed nickel	50.70	
			77 stainless steel	50.70	
			79 aluminium	39.40	
	finial Concept	22801	50 white	87.80	
			51 anthracite	87.80	
			70 chromium	117.10	
			72 brushed nickel	100.20	
			77 stainless steel	100.20	
			79 aluminium	87.80	
	finial Convex	22802	50 white	87.80	
			51 anthracite	87.80	
			70 chromium	117.10	
			72 brushed nickel	100.20	
			77 stainless steel	100.20	
			79 aluminium	87.80	
	bracket 3"	22811	50 white	132.80	
			51 anthracite	132.80	
			70 chromium	182.30	
			72 brushed nickel	154.20	
			77 stainless steel	154.20	
			79 aluminium	132.80	
	bracket 5"	22812	50 white	144.00	
			51 anthracite	144.00	
			70 chromium	197.60	
			72 brushed nickel	166.60	
			77 stainless steel	166.60	
			79 aluminium	144.00	
	bracket 7"	22813	50 white	155.30	
			51 anthracite	155.30	
			70 chromium	212.90	
			72 brushed nickel	181.30	
			77 stainless steel	181.30	
			79 aluminium	155.30	
	double bracket 3"	22821	50 white	159.80	
			51 anthracite	159.80	
			70 chromium	219.00	
			72 brushed nickel	186.20	
			77 stainless steel	186.20	
			79 aluminium	159.80	

traversing geometric square 3/4"

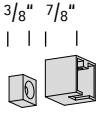
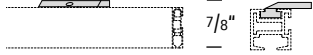

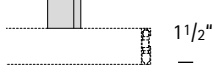
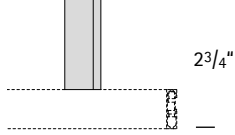

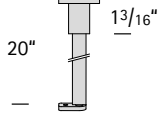
components	part	part-no.	color-no.	price
	double bracket 5"	22822	50 white	171.10
			51 anthracite	171.10
			70 chromium	234.30
			72 brushed nickel	199.50
			77 stainless steel	199.50
			79 aluminium	171.10
	bracket 3 3/4"	22831	72 brushed nickel	222.90
			77 stainless steel	222.90
			79 aluminium	200.40
	bracket 6"	22832	72 brushed nickel	240.90
			77 stainless steel	240.90
			79 aluminium	218.40
	bracket 3" flat	28711	50 white	149.70
			51 anthracite	149.70
			70 chromium	204.90
			72 brushed nickel	172.20
			77 stainless steel	172.20
			79 aluminium	149.70
	bracket 5" flat	28712	50 white	160.90
			51 anthracite	160.90
			70 chromium	222.90
			72 brushed nickel	185.10
			77 stainless steel	185.10
			79 aluminium	160.90
	bracket 7" flat	28713	50 white	172.20
			51 anthracite	172.20
			70 chromium	240.90
			72 brushed nickel	198.10
			77 stainless steel	198.10
			79 aluminium	172.20
	shorten bracket for bracket 22811-22822 e.g. 22812-77-S-4" not for brackets 22831-22832	S		surcharge 64.00
	shorten bracket for bracket 28711-28713 e.g. 28712-77-S-4" not for brackets 22831-22832	S		surcharge 64.00

traversing geometric square 3/4"



components	part	part-no.	color-no.	price	
	wall socket can be used at both ends	22805	50	white	58.50
			51	anthracite	58.50
			70	chromium	78.80
			72	brushed nickel	67.30
			77	stainless steel	67.30
			79	aluminium	58.50
	ceiling bracket close to ceiling shadow gap 1/8"	30514	50	white	20.00
			79	aluminium	20.00
	ceiling bracket close to ceiling for double rod shadow gap 1/8"	30524	50	white	33.30
			79	aluminium	33.30
	ceiling bracket 3/4" square	17914	50	white	74.30
			51	anthracite	74.30
			70	chromium	101.30
			72	brushed nickel	85.50
			77	stainless steel	85.50
			79	aluminium	74.30
	ceiling bracket 2" square	17916	50	white	88.90
			51	anthracite	88.90
			70	chromium	120.40
			72	brushed nickel	103.50
			77	stainless steel	103.50
			79	aluminium	88.90
	extension piece 3/4" for brackets 17914, 17916	17917	50	white	33.80
			51	anthracite	33.80
			70	chromium	44.60
			72	brushed nickel	38.30
			77	stainless steel	38.30
			79	aluminium	33.80
	ceiling bracket 20", can be shortened square	21715	50	white	165.40
			51	anthracite	165.40
			70	chromium	258.90
			72	brushed nickel	198.10
			77	stainless steel	198.10
			79	aluminium	165.40

price list 2018

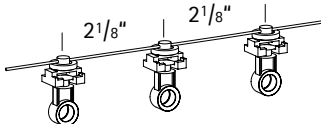
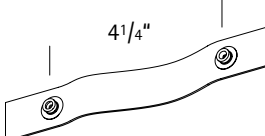
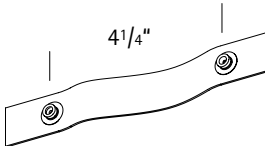
traversing geometric square 3/4"

components	part	part-no.	color-no.	price
	roller with eyelet	30082	50 white	0.80
	curtain hook	30080	50 white	0.20
	runner for batons can be retrofitted	30078	50 white	3.60
	stop clamp	30089	50 white	1.80
	carriers with cord spacing between carriers 2 1/8" with easy snap for convenient installation	40 pcs 29085/40 60 pcs 29085/60 80 pcs 29085/80 100 pcs 29085/100 120 pcs 29085/120	50 white 50 white 50 white 50 white 50 white	52.00 78.00 104.00 130.00 156.00
	ripplefold tape spacing between buttons 4 1/4" 100 % fullness spool 100 yards	29012	50 white 11 transparent	413.60 413.60
	ripplefold tape spacing between buttons 4 1/4" 100 % fullness cut to measure	29010	50 white 11 transparent	per lin. ft. 1.70 per lin. ft. 1.70

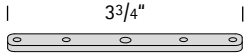
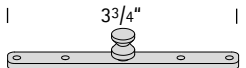
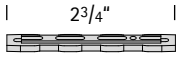
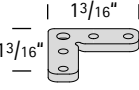
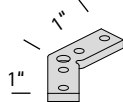
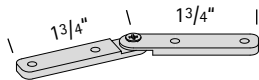
traversing geometric square 3/4"

components	part	part-no.	color-no.	price
	connector	30578	99	16.90
	connector for brackets 17914, 17916	30577	99	16.90
	connector for brackets 30514, 30524 (plastic)	21719	99	13.50
	corner connector 90° mitre cut \$ 43.00	30550	99	25.90
	corner connector 135° mitre cut \$ 43.00	30551	99	30.40
	corner connector flexible mitre cut \$ 43.00	30552	99	59.70
	batons	see page 275		

page 50



page 56

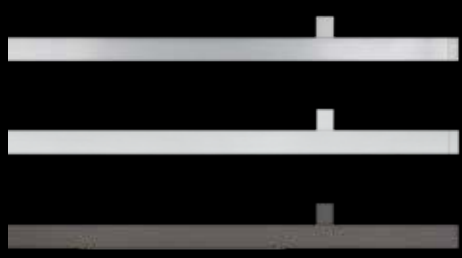

traversing
geometric

square 3/4"

ceiling

novum 2 aluminium



finishes available



50 white
(Novum only)



51 anthracite
(Novum only)



70 chromium



72 brushed nickel
(Novum only)



77 stainless steel



79 aluminium



quantum 2 77 stainless steel



votum 2 79 aluminium



novum 2 70 chromium



scale 1:1

finishes available



50 white
(Novum only)



51 anthracite
(Novum only)



70 chromium



72 brushed nickel
(Novum only)



77 stainless steel



79 aluminium



quantum 2 77 stainless steel



votum 2 79 aluminium



novum 2 70 chromium



scale 1:1

traversing geometric square 3/4"

finishes available

material: aluminium

- A 79 aluminium
- B 77 stainless steel
- C 70 chromium (single rod only)

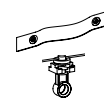

single rod

length rollers brackets  1 3/4"

ripplefold

(ft.)				A	B	C	surcharge
3	16	2	\$	360	419	524	61
4	20	2		383	447	570	58
5	24	3		548	639	806	54
6	30	3		573	668	853	50
7	34	3		596	697	899	87
8	40	3		621	726	946	82
9	44	4		786	918	1182	79
• 10	50	4		810	948	1229	74
11	54	4		833	976	1275	107
12	60	4		858	1006	1322	102
13	64	4		881	1034	1368	99
14	68	5		1046	1226	1604	136
15	74	5		1071	1256	1651	131
16	78	5		1094	1284	1697	128
17	84	5		1119	1314	1744	123
18	88	5		1142	1342	1790	148



length →

set-no.

Quantum 2 02136

set without
finials

finials see
page 58



double rod

length rollers brackets  1 3/4"

(ft.)				A	B
3	32	2	\$	510	595
4	40	2		556	651
5	48	3		781	913
6	60	3		831	973
7	68	3		877	1029
8	80	3		926	1089
9	88	4		1151	1351
• 10	100	4		1201	1411
11	108	4		1247	1467
12	120	4		1296	1527
13	128	4		1343	1583
14	136	5		1568	1846
15	148	5		1617	1905
16	156	5		1663	1962
17	168	5		1713	2021
18	176	5		1759	2078

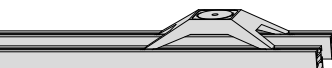

length →

set-no.

Quantum 2 02137

set without
finials (on both rods)

finials see
page 58



Notes

- rods in excess of 9ft. will be delivered in two sections



accessories see page 276

traversing geometric square 3/4"

finishes available

material: aluminium

- A 50 white (Novum only)
- 51 anthracite (Novum only)
- 79 aluminium
- B 72 brushed nickel (Novum only)
- 77 stainless steel
- C 70 chromium

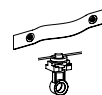

single rod

length rollers brackets  1 3/8"

ripplefold

(ft.)				A	B	C	surcharge
3	16	2	\$	297	346	434	61
4	20	2		320	374	480	58
5	24	3		454	529	671	54
6	30	3		478	559	718	50
7	34	3		501	587	764	87
8	40	3		526	617	811	82
9	44	4		660	773	1002	79
• 10	50	4		684	802	1049	74
11	54	4		707	831	1095	107
12	60	4		732	860	1142	102
13	64	4		755	889	1188	99
14	68	5		889	1044	1379	136
15	74	5		913	1074	1426	131
16	78	5		936	1102	1472	128
17	84	5		961	1132	1519	123
18	88	5		984	1160	1565	148

length →

set-no.

Votum 2 02138

set without
finials

finials see
page 58



single rod

length rollers brackets  2 1/16"

ripplefold

(ft.)				A	B	C	surcharge
3	16	2	\$	360	419	524	61
4	20	2		383	447	570	58
5	24	3		548	639	806	54
6	30	3		573	668	853	50
7	34	3		596	697	899	87
8	40	3		621	726	946	82
9	44	4		786	918	1182	79
• 10	50	4		810	948	1229	74
11	54	4		833	976	1275	107
12	60	4		858	1006	1322	102
13	64	4		881	1034	1368	99
14	68	5		1046	1226	1604	136
15	74	5		1071	1256	1651	131
16	78	5		1094	1284	1697	128
17	84	5		1119	1314	1744	123
18	88	5		1142	1342	1790	148

length →

set-no.

Novum 2 02139

set without
finials

finials see
page 58



Notes

- rods in excess of 9ft. will be delivered in two sections

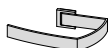

accessories see page 276



finishes available

50 white 51 anthracite 70 chromium 72 brushed nickel 77 stainless steel 79 aluminium

cubus 2 77 stainless steel



cubus 2 79 aluminium

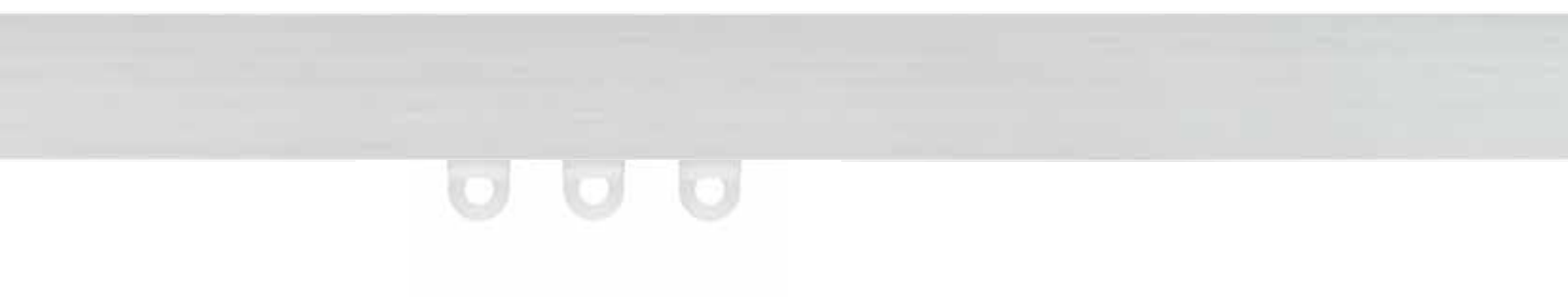

cubus 2 51 anthracite



scale 1:1



traversing geometric square 3/4"

finishes available

- A 50 white
- 51 anthracite
- 79 aluminium
- B 72 brushed nickel
- 77 stainless steel
- C 70 chromium

material: aluminium

single rod



length →

set-no.

Cubus 2 02199

set without
finials
finials see
below

length rollers brackets

(ft.)

	length (ft.)	rollers	brackets	\$	bracket 3/4"			bracket 2"			surcharge
					A	B	C	A	B	C	
	3	16	2		225	262	347	254	298	385	61
	4	20	2		248	291	392	277	327	430	58
	5	24	3		345	404	539	389	458	597	54
	6	30	3		370	434	587	414	488	644	50
	7	34	3		393	462	632	437	516	690	87
	8	40	3		418	492	680	462	546	737	82
	9	44	4		515	606	827	574	678	903	79
	• 10	50	4		540	636	874	598	708	950	74
	11	54	4		563	664	920	621	736	996	107
	12	60	4		588	694	967	646	766	1043	102
	13	64	4		611	722	1013	669	794	1089	99
	14	68	5		708	836	1160	781	926	1255	136
	15	74	5		733	865	1207	806	955	1302	131
	16	78	5		756	894	1253	829	984	1348	128
	17	84	5		781	923	1300	854	1013	1395	123
	18	88	5		804	952	1346	877	1042	1441	148

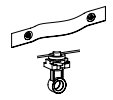
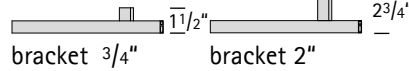

ripplefold

surcharge

Notes

- rods in excess of 9ft. will be delivered in two sections

components

part

part-no. color-no.

price

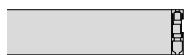

traversing rod 3/4" x 3/4"
square
material: aluminium

22870

50 white
51 anthracite
70 chromium
72 brushed nickel
77 stainless steel
79 aluminium

Cut to measure
\$/ lin ft. 19.90
19.90
42.50
25.00
25.00
19.90

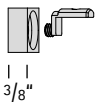

end cap
Compact

22829

50 white
51 anthracite
70 chromium
72 brushed nickel
77 stainless steel
79 aluminium

39.40
39.40
66.40
50.70
50.70
39.40

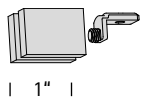

finial
Concept

22801

50 white
51 anthracite
70 chromium
72 brushed nickel
77 stainless steel
79 aluminium

87.80
87.80
117.10
100.20
100.20
87.80

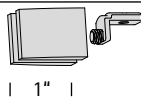

finial
Convex

22802

50 white
51 anthracite
70 chromium
72 brushed nickel
77 stainless steel
79 aluminium

87.80
87.80
117.10
100.20
100.20
87.80



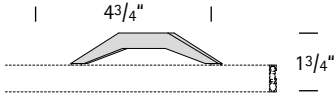
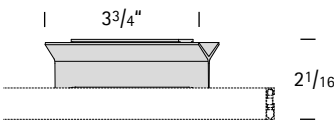

traversing geometric square 3/4"

components	part	part-no.	color-no.	price		
	ceiling bracket Quantum single rod	21716	70 chromium 77 stainless steel 79 aluminium	190.20 163.60 141.90		
	ceiling bracket Quantum double rod distance between rods 2"		21726	77 stainless steel 79 aluminium	205.90 178.90	
	ceiling bracket Votum			70 chromium 77 stainless steel 79 aluminium	145.20 127.20 110.40	
	ceiling bracket Novum	22815	50 white 51 anthracite 70 chromium 72 brushed nickel 77 stainless steel 79 aluminium	141.90 141.90 190.20 163.60 163.60 141.90		
	ceiling bracket Cubus 3/4" square		17914	50 white 51 anthracite 70 chromium 72 brushed nickel 77 stainless steel 79 aluminium	74.30 74.30 101.30 85.50 85.50 74.30	
	ceiling bracket Cubus 2" square			50 white 51 anthracite 70 chromium 72 brushed nickel 77 stainless steel 79 aluminium	88.90 88.90 120.40 103.50 103.50 88.90	
	extension piece 3/4" for brackets 17914, 17916			50 white 51 anthracite 70 chromium 72 brushed nickel 77 stainless steel 79 aluminium	33.80 33.80 44.60 38.30 38.30 33.80	
	wall socket can be used at both ends			22805	50 white 51 anthracite 70 chromium 72 brushed nickel 77 stainless steel 79 aluminium	58.50 58.50 78.80 67.30 67.30 58.50
	ceiling bracket close to ceiling shadow gap 1/8"				50 white 79 aluminium	20.00 20.00

traversing geometric square 3/4"

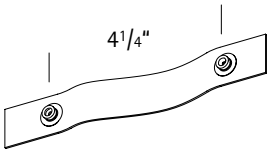
components	part	part-no.	color-no.	price		
	ceiling bracket close to ceiling for double rod shadow gap 1/8"	30524	50 79	white aluminium	33.30 33.30	
	ceiling bracket 20", can be shortened square	21715	50 51 70 72 77 79	white anthracite chromium brushed nickel stainless steel aluminium	165.40 165.40 258.90 198.10 198.10 165.40	
	roller with eyelet	30082	50	white	0.80	
	curtain hook	30080	50	white	0.20	
	runner for batons can be retrofitted	30078	50	white	3.60	
	stop clamp	30089	50	white	1.80	
	carriers with cord spacing between carriers 2 1/8" with easy snap for convenient installation	40 pcs 60 pcs 80 pcs 100 pcs 120 pcs	29085/40 29085/60 29085/80 29085/100 29085/120	50 50 50 50 50	white white white white white	52.00 78.00 104.00 130.00 156.00
	ripplefold tape spacing between buttons 4 1/4" 100 % fullness spool 100 yards	29012	50 11	white transparent	413.60 413.60	

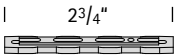
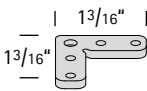
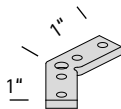
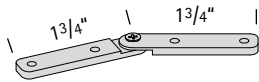
traversing geometric square 3/4"

components	part	part-no.	color-no.	price
	ripplefold tape spacing between buttons 4 1/4" 100 % fullness cut to measure	29010	50 11 white transparent	per lin. ft. 1.70 per lin. ft. 1.70
	connector for ceiling bracket Cubus	30577	99	16.90
	connector for brackets Quantum, Votum, Novum and 30514, 30524 (plastic)	21719	99	13.50
	corner connector 90° mitre cut \$ 43.00	30550	99	25.90
	corner connector 135° mitre cut \$ 43.00	30551	99	30.40
	corner connector flexible mitre cut \$ 43.00	30552	99	59.70
	batons	see page 275		

flat 1 1/8"

page 64



traversing
geometric

index 2 aluminium

index 1 stainless steel

finishes available



50 white
(Index 1 only)



51 anthracite
(Index 1 only)



70 chromium
(Index 1 only)



72 brushed nickel



77 stainless steel



79 brushed aluminium



index 2 79 aluminium



index 1 77 stainless steel



index 1 51 anthracite



scale 1:1



traversing geometric flat 1 1/8"

finishes available

material: aluminium

- A 50 white (Index 1 only)
- 51 anthracite (Index 1 only)
- 79 aluminium
- B 72 brushed nickel
- 77 stainless steel
- C 70 chromium (Index 1 only)

single rod

	length (ft.)	rollers	brackets	bracket 3"			bracket 5"			bracket 7"			ripplefold surcharge	
				A	B	C	A	B	C	A	B	C		
	3	16	2	\$ 506	562	681	529	587	717	551	613	753	61	
	4	20	2	530	589	727	553	615	763	575	641	799	58	
	5	24	2	554	617	773	577	643	809	599	669	845	54	
	6	30	3	730	818	1025	763	857	1079	797	896	1133	50	
	7	34	3	754	846	1071	787	885	1125	821	924	1179	87	
	8	40	3	780	875	1118	813	914	1172	847	953	1226	82	
	9	44	3	804	903	1164	837	941	1218	871	980	1272	79	
	10	50	3	829	932	1211	863	971	1265	897	1010	1319	74	
	11	54	4	1003	1132	1462	1048	1183	1534	1093	1235	1606	107	
	12	60	4	1029	1161	1509	1074	1212	1581	1119	1264	1653	102	
Index 1	set-no.	13	64	4	1053	1188	1555	1098	1240	1627	1143	1292	1699	99
freestanding (ending both sides)	02871*	14	68	4	1077	1216	1600	1122	1268	1672	1167	1320	1744	136
		15	74	4	1103	1245	1648	1148	1297	1720	1193	1349	1792	131
		16	78	4	1127	1273	1693	1172	1324	1765	1217	1376	1837	128
		17	84	5	1302	1474	1945	1358	1539	2035	1415	1604	2125	123
		18	88	5	1326	1502	1991	1382	1566	2081	1439	1631	2171	148
reduction for wall contact			with bracket	64	64	64	64	64	64	64	64	64	64	
			with wall socket	154	167	183	165	180	201	176	193	219		

▲ with wall contact

	bracket	wall socket
left	02892	02872
right	02893	02873
both sides	02894	02874

single rod

	length (ft.)	rollers	brackets	bracket 3 3/4"		bracket 6"		ripplefold surcharge	
				A	B	A	B		
	3	16	2	\$ 608	663	644	699	61	
	4	20	2	632	691	668	727	58	
	5	24	2	656	718	692	754	54	
	6	30	3	882	970	936	1024	50	
	7	34	3	906	998	960	1052	87	
	8	40	3	932	1027	986	1081	82	
	9	44	3	956	1055	1010	1109	79	
	10	50	3	981	1084	1035	1138	74	
	11	54	4	1206	1334	1278	1406	107	
	12	60	4	1232	1364	1304	1436	102	
	13	64	4	1256	1391	1328	1463	99	
Index 2	set-no.	14	68	4	1280	1419	1352	1491	136
freestanding (ending both sides)	02875*	15	74	4	1306	1448	1378	1520	131
		16	78	4	1330	1476	1402	1548	128
		17	84	5	1556	1728	1646	1818	123
		18	88	5	1580	1755	1670	1845	148
reduction for wall contact			with bracket	64	64	64	64		
			with wall socket	205	218	223	236		

▲ with wall contact

	bracket	wall socket
left	02896	02876
right	02897	02877
both sides	02898	02878

Notes

▲ bracket

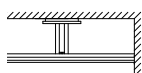

- rods in excess of 9ft. will be delivered in two sections

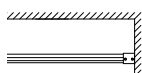

wall socket



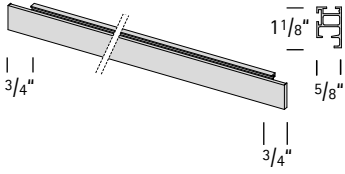
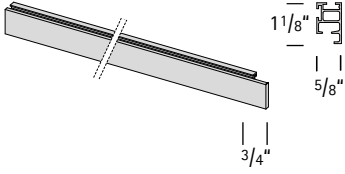
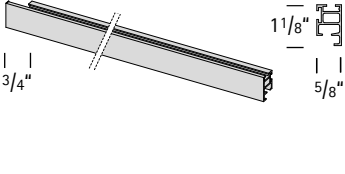
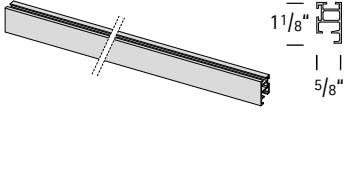

- * rod with ending on both sides cannot be shortened

accessories see page 276

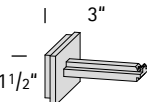
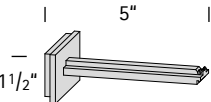
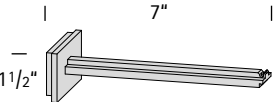
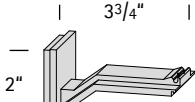

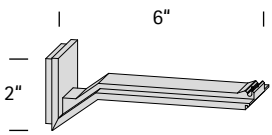
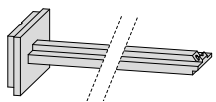
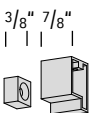
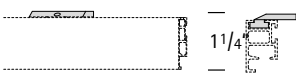
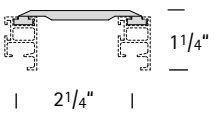
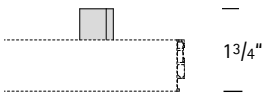
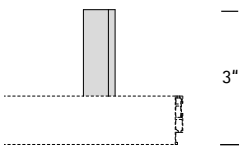

traversing geometric flat 1 1/8"

components	part	part-no.	color-no.	price	
	traversing rod flat 1 1/8" with ending 3/4" both sides cannot be shortened material: aluminium	28771	50 white	Cut to measure \$ / lin ft. 20.90	
			51 anthracite	20.90	
			70 chromium	42.50	
			72 brushed nickel	24.40	
			77 stainless steel	24.40	
			79 aluminium	20.90	
				+ \$ 114.00	
	traversing rod flat 1 1/8" with ending 3/4" right side, wall contact left side material: aluminium	28772	50 white	Cut to measure \$ / lin ft. 20.90	
			51 anthracite	20.90	
			70 chromium	42.50	
			72 brushed nickel	24.40	
			77 stainless steel	24.40	
			79 aluminium	20.90	
				+ \$ 57.00	
	traversing rod flat 1 1/8" with ending 3/4" left side, wall contact right side material: aluminium	28773	50 white	Cut to measure \$ / lin ft. 20.90	
			51 anthracite	20.90	
			70 chromium	42.50	
			72 brushed nickel	24.40	
			77 stainless steel	24.40	
			79 aluminium	20.90	
				+ \$ 57.00	
	traversing rod flat 1 1/8" for wall contact both sides material: aluminium	28770	50 white	Cut to measure \$ / lin ft. 20.90	
			51 anthracite	20.90	
			70 chromium	42.50	
			72 brushed nickel	24.40	
			77 stainless steel	24.40	
			79 aluminium	20.90	
	end cap for cut with ending 3/4"	right	28778	50 white	6.80
				51 anthracite	6.80
		left		70 chromium	6.80
				72 brushed nickel	6.80
				77 stainless steel	6.80
				79 aluminium	6.80
	bracket 3"	28711	50 white	149.70	
			51 anthracite	149.70	
			70 chromium	204.90	
			72 brushed nickel	172.20	
			77 stainless steel	172.20	
			79 aluminium	149.70	
	bracket 5"	28712	50 white	160.90	
			51 anthracite	160.90	
			70 chromium	222.90	
			72 brushed nickel	185.10	
			77 stainless steel	185.10	
			79 aluminium	160.90	
	bracket 7"	28713	50 white	172.20	
			51 anthracite	172.20	
			70 chromium	240.90	
			72 brushed nickel	198.10	
			77 stainless steel	198.10	
			79 aluminium	172.20	
	bracket 3 3/4"	22831	72 brushed nickel	222.90	
			77 stainless steel	222.90	
			79 aluminium	200.40	



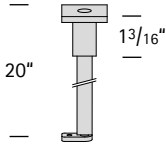

traversing geometric flat 1 1/8"

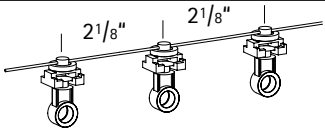
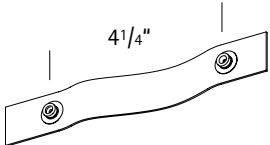
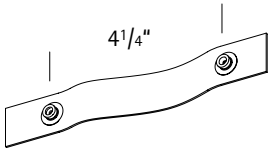
components	part	part-no.	color-no.	price
	bracket 6"	22832	72 brushed nickel	240.90
			77 stainless steel	240.90
			79 aluminium	218.40
	shorten bracket for brackets 28711-28713 e.g. 28712-77-S-4" not for brackets 22831, 22832	S		surcharge 64.00
	wall socket can be used at both ends only for cut without ending	28705	50 white	59.70
			51 anthracite	59.70
			70 chromium	85.50
			72 brushed nickel	68.70
			77 stainless steel	68.70
	79 aluminium	59.70		
	ceiling bracket close to ceiling shadow gap 1/8"	30514	50 white	20.00
			79 aluminium	20.00
	ceiling bracket close to ceiling for double rod shadow gap 1/8"	30524	50 white	33.30
			79 aluminium	33.30
	ceiling bracket 3/4" square	17914	50 white	74.30
			51 anthracite	74.30
			70 chromium	101.30
			72 brushed nickel	85.50
			77 stainless steel	85.50
	79 aluminium	74.30		
	ceiling bracket 2" square	17916	50 white	88.90
			51 anthracite	88.90
			70 chromium	120.40
			72 brushed nickel	103.50
			77 stainless steel	103.50
	79 aluminium	88.90		
	extension piece 3/4" for brackets 17914, 17916	17917	50 white	33.80
			51 anthracite	33.80
			70 chromium	44.60
			72 brushed nickel	38.30
			77 stainless steel	38.30
	79 aluminium	33.80		

traversing geometric flat 1 1/8"

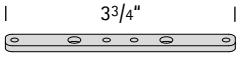
components	part	part-no.	color-no.	price		
	ceiling bracket 20", can be shortened square	21715	50	white	165.40	
			51	anthracite	165.40	
			70	chromium	258.90	
			72	brushed nickel	198.10	
			77	stainless steel	198.10	
			79	aluminium	165.40	
	roller with eyelet	30082	50	white	0.80	
	curtain hook	30080	50	white	0.20	
	runner for batons can be retrofitted	30078	50	white	3.60	
	stop clamp	30089	50	white	1.80	
	carriers with cord spacing between carriers 2 1/8" with easy snap for convenient installation	40 pcs	29085/40	50	white	52.00
		60 pcs	29085/60	50	white	78.00
		80 pcs	29085/80	50	white	104.00
		100 pcs	29085/100	50	white	130.00
		120 pcs	29085/120	50	white	156.00
	ripplefold tape spacing between buttons 4 1/4" 100 % fullness spool 100 yards	29012	50	white	413.60	
			11	transparent	413.60	
	ripplefold tape spacing between buttons 4 1/4" 100 % fullness cut to measure	29010	50	white	per lin. ft. 1.70	
			11	transparent	per lin. ft. 1.70	

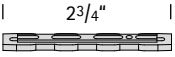
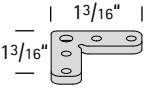
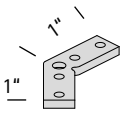
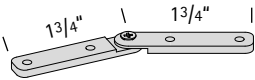
traversing geometric flat 1 1/8"

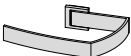
components	part	part-no.	color-no.	price
	connector	30579	99	16.90
	connector for ceiling brackets 17914, 17916	30577	99	16.90
	connector for brackets 30514, 30524 (plastic)	21719	99	13.50
	corner connector 90° mitre cut \$ 43.00	30550	99	25.90
	corner connector 135° mitre cut \$ 43.00	30551	99	30.40
	corner connector flexible mitre cut \$ 43.00	30552	99	59.70
	batons		see page 275	
	accessories		see page 276	



traversing
geometric

flat 1 1/8"

ceiling

helix white





finishes available

50 white 51 anthracite 70 chromium 72 brushed nickel 77 stainless steel 79 aluminium

helix 77 stainless steel



helix 79 aluminium



helix 50 white



scale 1:1



traversing geometric flat 1 1/8"

finishes available

- A 50 white
51 anthracite
79 aluminium
- B 72 brushed nickel
77 stainless steel
- C 70 chromium

material: aluminium
ceiling bracket: white

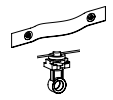

single rod

length rollers brackets



ripplefold

(ft.)				A	B	C	surcharge	
3	16	2	\$	247	257	312	61	
4	20	2		271	285	357	58	
5	24	3		315	332	423	54	
6	30	3		341	362	470	50	
7	34	3		365	389	516	87	
8	40	3		390	418	563	82	
9	44	4		435	466	629	79	
• 10	50	4		460	495	676	74	
11	54	4		484	523	722	107	
12	60	4		510	552	769	102	
13	64	4		534	580	815	99	
Helix	set-no.	14	68	5	578	627	881	136
freestanding	02881*	15	74	5	604	656	928	131
(ending both sides)		16	78	5	628	684	974	128
wall contact left side	02882	17	84	5	654	713	1021	123
(ending right side only)		18	88	5	678	741	1067	148
wall contact right side	02883	reduction per wall contact			64	64	64	
(ending left side only)								
wall to wall	02884							



length ending 3/4"

- Helix** set-no.
- freestanding** 02881*
(ending both sides)
- wall contact left side** 02882
(ending right side only)
- wall contact right side** 02883
(ending left side only)
- wall to wall** 02884

double rod

length rollers brackets

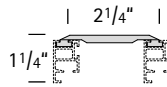

(ft.)				A	B	C	
3	32	2	\$	480	501	610	
4	40	2		528	556	701	
5	48	3		610	645	826	
6	60	3		661	703	920	
7	68	3		709	758	1012	
8	80	3		761	817	1106	
9	88	4		842	905	1231	
• 10	100	4		894	964	1326	
11	108	4		942	1019	1417	
12	120	4		993	1077	1512	
13	128	4		1041	1132	1603	
Helix	set-no.	14	136	5	1123	1221	1728
freestanding	02885*	15	148	5	1174	1279	1822
(ending both sides)		16	156	5	1223	1335	1914
wall contact left side	02886	17	168	5	1274	1393	2008
(ending right side only)		18	176	5	1322	1448	2100
wall contact right side	02887	reduction per wall contact			128	128	128
(ending left side only)							
wall to wall	02888						



length ending 3/4"

- Helix** set-no.
- freestanding** 02885*
(ending both sides)
- wall contact left side** 02886
(ending right side only)
- wall contact right side** 02887
(ending left side only)
- wall to wall** 02888

Notes

• rods in excess of 9ft. will be delivered in two sections

* rod with ending on both sides cannot be shortened

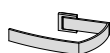





accessories see page see page 276



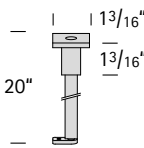

traversing geometric flat 1 1/8"

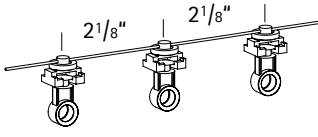
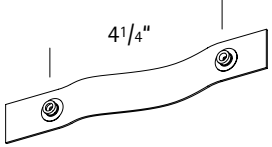
components	part	part-no.	color-no.	price		
	traversing rod flat 1 1/8" with ending 3/4" both sides cannot be shortened material: aluminium	28771	50 white	Cut to measure \$ / lin. ft. 20.90 20.90 42.50 24.40 24.40 20.90		
			51 anthracite			
			70 chromium			
			72 brushed nickel			
			77 stainless steel			
			79 aluminium			
				+ \$ 114.00		
	traversing rod flat 1 1/8" with ending 3/4" right side, wall contact left side material: aluminium	28772	50 white	Cut to measure \$ / lin. ft. 20.90 20.90 42.50 24.40 24.40 20.90		
			51 anthracite			
			70 chromium			
			72 brushed nickel			
			77 stainless steel			
			79 aluminium			
				+ \$ 57.00		
	traversing rod flat 1 1/8" with ending 3/4" left side, wall contact right side material: aluminium	28773	50 white	Cut to measure \$ / lin. ft. 20.90 20.90 42.50 24.40 24.40 20.90		
			51 anthracite			
			70 chromium			
			72 brushed nickel			
			77 stainless steel			
			79 aluminium			
				+ \$ 57.00		
	traversing rod flat 1 1/8" for wall contact both sides material: aluminium	28770	50 white	Cut to measure \$ / lin. ft. 20.90 20.90 42.50 24.40 24.40 20.90		
			51 anthracite			
			70 chromium			
			72 brushed nickel			
			77 stainless steel			
			79 aluminium			
				+ \$ 114.00		
	end cap for cut with ending 3/4"	right	28778	50 white	6.80	
			51 anthracite			
		left	28779	70 chromium		6.80
			72 brushed nickel	6.80		
			77 stainless steel	6.80		
			79 aluminium	6.80		
	ceiling bracket close to ceiling shadow gap 1/8"	30514	50 white	20.00		
			79 aluminium		20.00	
	ceiling bracket close to ceiling for double rod shadow gap 1/8"	30524	50 white	33.30		
			79 aluminium		33.30	
	ceiling bracket 3/4" square	17914	50 white	74.30		
			51 anthracite		74.30	
			70 chromium		101.30	
			72 brushed nickel		85.50	
			77 stainless steel		85.50	
			79 aluminium		74.30	
	ceiling bracket 2" square	17916	50 white	88.90		
			51 anthracite		88.90	
			70 chromium		120.40	
			72 brushed nickel		103.50	
			77 stainless steel		103.50	
			79 aluminium		88.90	

traversing geometric flat 1 1/8"

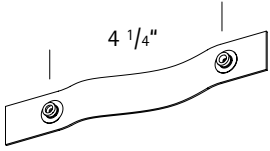
components	part	part-no.	color-no.	price
	extension piece 3/4" for brackets 17914, 17916	17917	50 white 51 anthracite 70 chromium 72 brushed nickel 77 stainless steel 79 aluminium	33.80 33.80 44.60 38.30 38.30 33.80
	ceiling bracket 20", can be shortened square	21715	50 white 51 anthracite 70 chromium 72 brushed nickel 77 stainless steel 79 aluminium	165.40 165.40 258.90 198.10 198.10 165.40
	roller with eyelet	30082	50 white	0.80
	curtain hook	30080	50 white	0.20
	runner for batons can be retrofitted	30078	50 white	3.60
	stop clamp	30089	50 white	1.80
	carriers with cord spacing between carriers 2 1/8" with easy snap for convenient installation	40 pcs 29085/40 60 pcs 29085/60 80 pcs 29085/80 100 pcs 29085/100 120 pcs 29085/120	50 white 50 white 50 white 50 white 50 white	52.00 78.00 104.00 130.00 156.00
	ripplefold tape spacing between buttons 4 1/4" 100 % fullness spool 100 yards	29012	50 white 11 transparent	413.60 413.60

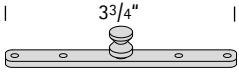
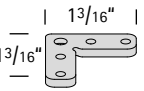
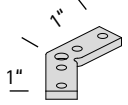
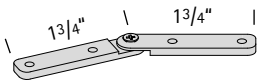
traversing geometric flat 1 1/8"

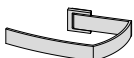
components	part	part-no.	color-no.	price
	ripplefold tape spacing between buttons 4 1/4" 100 % fullness cut to measure	29010	50 11 white transparent	per lin. ft. 1.70 per lin. ft. 1.70
	connector for brackets 30514 and 30524 (plastic)	21719	99	13.50
	connector for ceiling brackets 17914, 17916	30577	99	16.90
	corner connector 90° mitre cut \$ 43.00	30550	99	25.90
	corner connector 135° mitre cut \$ 43.00	30551	99	30.40
	corner connector flexible mitre cut \$ 43.00	30552	99	59.70
	batons			see page 275
	accessories			see page 276

page 80

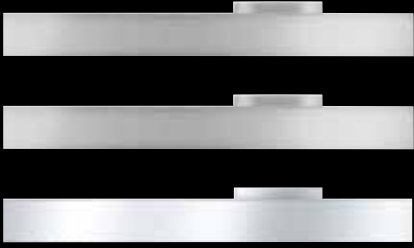

page 88



page 98



page 102



traversing
geometric

flat 1 3/8"

codex stainless steel

codex aluminium

finishes available



50 white



70 chromium



77 stainless steel



79 aluminium

codex 79 aluminium



codex 77 stainless steel



codex 70 chromium



scale 1:1



traversing geometric flat 1 3/8"

finishes available

material: aluminium

- A 50 white
79 aluminium
- B 77 stainless steel
- C 70 chromium

single rod

length	rollers	brackets		bracket 3"			bracket 5"			bracket 7"			ripplefold surcharge	
				A	B	C	A	B	C	A	B	C		
3	16	2	\$	523	585	716	550	615	754	577	646	792	61	
4	20	2		549	616	765	576	645	803	603	677	841	58	
5	24	2		574	646	814	602	676	852	629	707	889	54	
6	30	2		602	678	864	629	708	902	656	739	940	50	
7	34	3		783	888	1131	824	933	1188	864	980	1244	87	
8	40	3		810	920	1181	851	965	1238	892	1012	1294	82	
9	44	3		836	951	1230	877	995	1287	917	1042	1343	79	
10	50	3		864	983	1280	904	1028	1337	945	1074	1394	74	
11	54	3		889	1013	1329	930	1058	1386	971	1105	1442	107	
12	60	3		917	1045	1379	958	1090	1436	998	1137	1493	102	
13	64	4		1098	1255	1646	1152	1315	1722	1206	1377	1797	99	
14	68	4		1124	1286	1694	1178	1345	1770	1232	1408	1846	136	
15	74	4		1151	1318	1745	1205	1378	1821	1259	1440	1896	131	
16	78	4		1177	1348	1794	1231	1408	1870	1285	1470	1945	128	
17	84	4		1204	1381	1844	1259	1440	1920	1313	1503	1995	123	
18	88	4		1230	1411	1893	1284	1471	1969	1338	1533	2044	148	
reduction for wall contact				with bracket	64	64	64	64	64	64	64	64	64	
				with wall socket	165	189	228	179	204	247	192	220	265	

▲ with wall contact

	bracket	wall socket
left	03652	03642
right	03653	03643
both sides	03654	03644

double rod

length	rollers	brackets		bracket 3"			bracket 5"			bracket 7"			
				A	B	C	A	B	C	A	B	C	
3	32	2	\$	876	970	1214	903	1000	1252	930	1031	1290	
4	40	2		927	1031	1312	954	1061	1350	981	1092	1388	
5	48	2		979	1092	1410	1006	1122	1448	1033	1153	1485	
6	60	2		1034	1156	1510	1061	1186	1548	1088	1217	1586	
7	68	3		1311	1476	1934	1352	1521	1991	1392	1567	2047	
8	80	3		1366	1540	2035	1406	1585	2092	1447	1632	2148	
9	88	3		1417	1601	2132	1458	1646	2189	1499	1693	2246	
10	100	3		1472	1665	2233	1513	1710	2290	1553	1757	2347	
11	108	3		1524	1726	2331	1564	1771	2388	1605	1818	2444	
12	120	3		1578	1791	2432	1619	1835	2489	1660	1882	2545	
13	128	4		1856	2110	2855	1910	2170	2931	1964	2232	3006	
14	136	4		1907	2171	2953	1962	2231	3029	2016	2293	3104	
15	148	4		1962	2235	3054	2016	2295	3130	2070	2357	3205	
16	156	4		2014	2296	3151	2068	2356	3227	2122	2418	3302	
17	168	4		2068	2361	3252	2123	2420	3328	2177	2483	3403	
18	176	4		2120	2422	3350	2174	2481	3426	2228	2544	3501	
reduction for wall contact				with bracket	128	128	128	128	128	128	128	128	128
				with wall socket	246	279	346	259	294	365	273	309	384

▲ with wall contact

	bracket	wall socket
left	03656	03646
right	03657	03647
both sides	03658	03648

Notes

▲ bracket

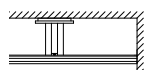

wall socket

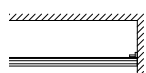

• rods in excess of 9ft. will be delivered in two sections

* rod with ending on both sides cannot be shortened

accessories see page 276





traversing geometric flat 1 3/8"

components	part	part-no.	color-no.	price			
	traversing rod flat 1 3/8" with ending 3/4" both sides cannot be shortened material: aluminium	36780	50	white	Cut to measure \$ / lin ft. 22.60 45.60 27.30 22.60 } + \$ 114.00		
		70	70	chromium			
		77	77	stainless steel			
		79	79	aluminium			
	traversing rod flat 1 3/8" with ending 3/4" right side, wall contact left side material: aluminium	36781	50	white	Cut to measure \$ / lin ft. 22.60 45.60 27.30 22.60 } + \$ 57.00		
		70	70	chromium			
		77	77	stainless steel			
		79	79	aluminium			
	traversing rod flat 1 3/8" with ending 3/4" left side, wall contact right side material: aluminium	36782	50	white	Cut to measure \$ / lin ft. 22.60 45.60 27.30 22.60 } + \$ 57.00		
		70	70	chromium			
		77	77	stainless steel			
		79	79	aluminium			
	traversing rod flat 1 3/8" for wall contact both sides material: aluminium	36770	50	white	Cut to measure \$ / lin ft. 22.60 45.60 27.30 22.60		
		70	70	chromium			
		77	77	stainless steel			
		79	79	aluminium			
	end cap for cut with ending 3/4"	right	36788	50	white	7.00	
				70	70	chromium	7.00
				77	77	stainless steel	7.00
		left	36789	79	79	aluminium	7.00
	bracket 3"	36811	50	white	155.30		
		70	70	chromium	217.50		
		77	77	stainless steel	179.40		
		79	79	aluminium	155.30		
	bracket 5"	36812	50	white	168.90		
		70	70	chromium	236.50		
		77	77	stainless steel	194.30		
		79	79	aluminium	168.90		
	bracket 7"	36813	50	white	182.40		
		70	70	chromium	255.30		
		77	77	stainless steel	209.90		
		79	79	aluminium	182.40		
	double bracket 3"	36821	50	white	225.60		
		70	70	chromium	326.00		
		77	77	stainless steel	258.70		
		79	79	aluminium	225.60		
	double bracket 5"	36822	50	white	239.20		
		70	70	chromium	345.00		
		77	77	stainless steel	273.60		
		79	79	aluminium	239.20		



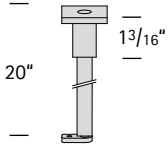

traversing geometric flat 1³/₈"

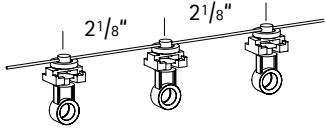
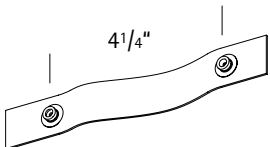
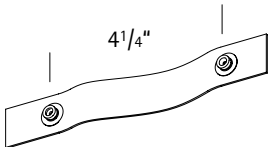
components	part	part-no.	color-no.	price
	double bracket 7"	36823	50 white	252.70
			70 chromium	363.80
			77 stainless steel	289.20
			79 aluminium	252.70
	extention piece for additional track	83721	50 white	56.30
			70 chromium	94.50
			77 stainless steel	65.30
			79 aluminium	56.30
	larger base plate for single rod brackets e.g. 36812X	X		surcharge 14.00
	shorten bracket e.g. 36812-77-S-4"	S		surcharge 64.00
	wall socket can be used at both ends for hidden mount only for cut without ending	36707	50 white	54.00
	ceiling bracket for hidden mount shadow gap adjustable 0 - 3/8"	36615	50 white	51.30
	ceiling bracket close to ceiling for double rod shadow gap 1/8"	30524	50 white 79 aluminium	33.30 33.30
	ceiling bracket 3/4" square	17914	50 white 70 chromium 77 stainless steel 79 aluminium	74.30 101.30 85.50 74.30
	ceiling bracket 2" square	17916	50 white 70 chromium 77 stainless steel 79 aluminium	88.90 120.40 103.50 88.90

traversing geometric flat 1 3/8"

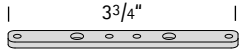
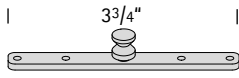
components	part	part-no.	color-no.	price		
	extension piece 3/4" for brackets 17914, 17916	17917	50	white	33.80	
				70	chromium	44.60
				77	stainless steel	38.30
				79	aluminium	33.80
	ceiling bracket 2", can be shortened square	21715	50	white	165.40	
				70	chromium	258.90
				77	stainless steel	198.10
				79	aluminium	165.40
	roller with eyelet	30082	50	white	0.80	
	curtain hook	30080	50	white	0.20	
	runner for batons can be retrofitted	30078	50	white	3.60	
	stop clamp	30089	50	white	1.80	
	carriers with cord spacing between carriers 2 1/8" with easy snap for convenient installation	40 pcs	29085/40	50	white	52.00
		60 pcs	29085/60	50	white	78.00
		80 pcs	29085/80	50	white	104.00
		100 pcs	29085/100	50	white	130.00
		120 pcs	29085/120	50	white	156.00
	ripplefold tape spacing between buttons 4 1/4" 100 % fullness spool 100 yards	29012	50	white	413.60	
				11	transparent	413.60
	ripplefold tape spacing between buttons 4 1/4" 100 % fullness cut to measure	29010	50	white	per lin. ft. 1.70	
				11	transparent	per lin. ft. 1.70

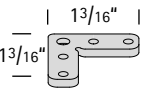
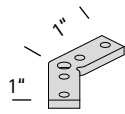
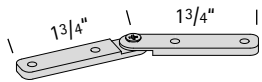
traversing geometric flat 1³/₈"

components	part	part-no.	color-no.	price
	connector	30579	99	16.90
	connector for ceiling brackets 17914, 17916	30577	99	16.90
	connector for bracket 30524 (plastic)	21719	99	13.50
	corner connector 90° mitre cut \$ 43.00	30550	99	25.90
	corner connector 135° mitre cut \$ 43.00	30551	99	30.40
	corner connector flexible mitre cut \$ 43.00	30552	99	59.70
	batons			see page 275
	accessories			see page 276



vision aluminium



ambition aluminium/black



dimension stainless steel



finishes available

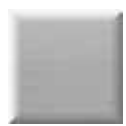

77 stainless steel



79 aluminium

dimension 79/78 aluminium/polished aluminium



vision 77 stainless steel



ambition 77/52 stainless steel/brown



scale 1:1

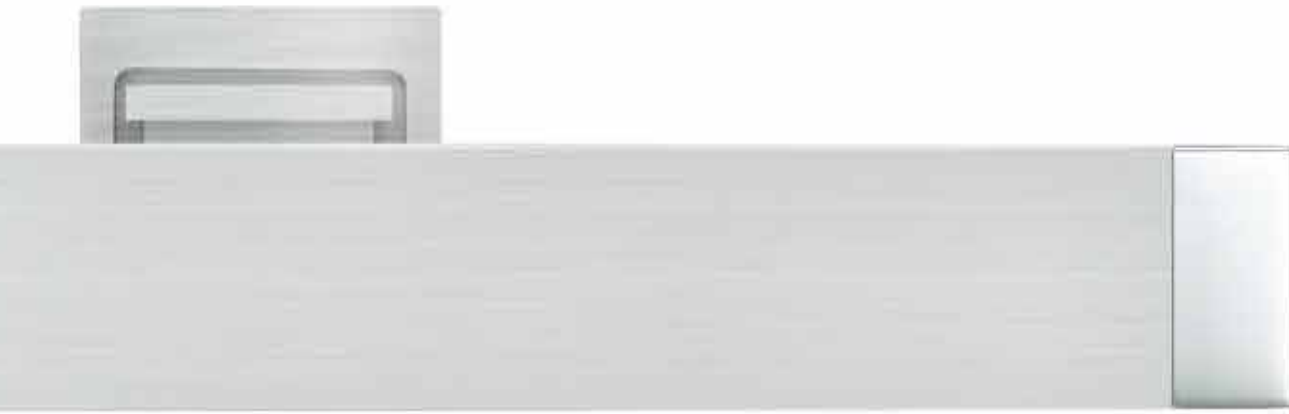

finials ambition



57 cognac



52 brown



56 black

traversing geometric flat 1 3/8"

finishes available

material: aluminium

- A 79 aluminium
- 79/78 aluminium/polished aluminium
- B 77 stainless steel
- 77/78 stainless steel/polished aluminium

single rod



length → 5/8"

set-no.

Dimension 03621

length (ft.)	rollers	brackets		bracket 3"		bracket 5"		bracket 7"		ripplefold surcharge
				A	B	A	B	A	B	
3	16	2	\$	474	530	501	562	528	593	61
4	20	2		499	561	526	592	553	624	58
5	24	2		525	591	552	623	579	654	54
6	30	2		553	623	580	655	607	686	50
7	34	3		719	816	760	863	800	910	87
8	40	3		747	848	787	895	828	942	82
9	44	3		772	878	813	925	853	973	79
• 10	50	3		800	910	840	957	881	1005	74
11	54	3		826	941	866	988	907	1035	107
12	60	3		853	973	893	1020	934	1067	102
13	64	4		1019	1165	1073	1228	1127	1291	99
14	68	4		1045	1196	1099	1259	1153	1322	136
15	74	4		1073	1228	1127	1291	1181	1354	131
16	78	4		1098	1258	1152	1321	1206	1384	128
17	84	4		1126	1291	1180	1353	1234	1417	123
18	88	4		1152	1321	1206	1384	1260	1447	148
^ reduction per wall socket				134	146	147	162	161	178	

double rod



length → 5/8"

set-no.

Dimension 03624

length (ft.)	rollers	brackets		bracket 3"		bracket 5"	
				A	B	A	B
3	32	2	\$	677	782	704	814
4	40	3		893	1034	934	1082
5	48	3		939	1091	980	1138
6	60	3		989	1151	1029	1198
7	68	3		1035	1208	1075	1255
8	80	4		1254	1463	1308	1526
9	88	4		1300	1520	1354	1583
• 10	100	4		1350	1580	1404	1643
11	108	4		1396	1636	1450	1700
12	120	5		1615	1892	1683	1971
13	128	5		1662	1949	1729	2028
14	136	5		1708	2005	1775	2084
15	148	5		1757	2065	1825	2144
16	156	6		1973	2317	2054	2412
17	168	6		2023	2377	2104	2472
18	176	6		2069	2434	2150	2529
^ reduction per wall socket				145	164	159	180

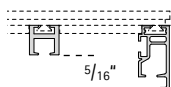

Notes



larger base plate + \$ 18.00 per bracket

^ position wall socket left/right, please specify

• rods in excess of 9ft. will be delivered in two sections

traversing geometric flat 1³/₈"

finishes available

A 79 aluminium

B 77 stainless steel

material: aluminium

single rod

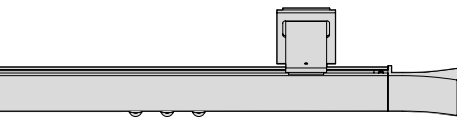

length → 2¹/₄" |

set-no.

■ Vision 03622

length (ft.)	rollers	brackets		bracket 3"		bracket 5"		bracket 7"		ripplefold surcharge
				A	B	A	B	A	B	
3	16	2	\$	541	624	568	656	595	687	61
4	20	2		567	655	594	686	621	718	58
5	24	2		593	685	620	717	647	748	54
6	30	2		620	717	647	749	674	780	50
7	34	3		787	910	827	957	868	1004	87
8	40	3		814	942	855	989	895	1036	82
9	44	3		840	972	880	1019	921	1067	79
• 10	50	3		867	1004	908	1051	948	1099	74
11	54	3		893	1035	934	1082	974	1129	107
12	60	3		921	1067	961	1114	1002	1161	102
13	64	4		1087	1259	1141	1322	1195	1385	99
14	68	4		1113	1290	1167	1353	1221	1416	136
15	74	4		1140	1322	1194	1385	1248	1448	131
16	78	4		1166	1352	1220	1415	1274	1478	128
17	84	4		1193	1385	1247	1447	1301	1511	123
18	88	4		1219	1415	1273	1478	1327	1541	148
^reduction per wall socket				168	193	181	209	195	225	

double rod

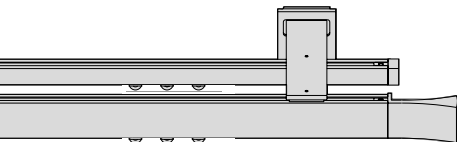

length → 2¹/₄" |

set-no.

■ Vision 03625

length (ft.)	rollers	brackets		bracket 3"		bracket 5"	
				A	B	A	B
3	32	2	\$	744	876	771	908
4	40	3		961	1128	1001	1176
5	48	3		1007	1185	1047	1232
6	60	3		1056	1245	1097	1292
7	68	3		1102	1302	1143	1349
8	80	4		1322	1557	1376	1620
9	88	4		1368	1614	1422	1677
• 10	100	4		1417	1674	1471	1737
11	108	4		1464	1730	1518	1794
12	120	5		1683	1986	1751	2065
13	128	5		1729	2043	1797	2122
14	136	5		1775	2099	1843	2178
15	148	5		1825	2159	1892	2238
16	156	6		2041	2411	2122	2506
17	168	6		2090	2471	2171	2566
18	176	6		2137	2528	2218	2623
^reduction per wall socket				179	211	193	227

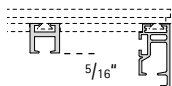

Notes



larger base plate + \$ 18.00 per bracket

^ position wall socket left/right, please specify

• rods in excess of 9ft. will be delivered in two sections

components see page 93

traversing geometric flat 1 3/8"

finishes available

A 79/52 aluminium/brown
79/56 aluminium/black
79/57 aluminium/cognac

material: aluminium (finals with genuine leather)

B 77/52 stainless steel/brown
77/56 stainless steel/black
77/57 stainless steel/cognac

single rod

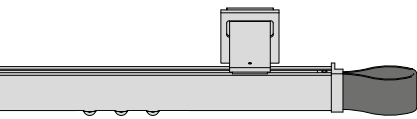

length → 3"

set-no. **Ambition** 03623

length (ft.)	rollers	brackets		bracket 3"		bracket 5"		bracket 7"		ripplefold surcharge
				A	B	A	B	A	B	
3	16	2	\$	640	722	667	753	694	785	61
4	20	2		666	752	693	783	720	815	58
5	24	2		692	783	719	814	746	846	54
6	30	2		719	815	746	846	773	878	50
7	34	3		886	1007	926	1054	967	1102	87
8	40	3		913	1039	954	1086	994	1134	82
9	44	3		939	1070	979	1117	1020	1164	79
• 10	50	3		966	1102	1007	1149	1047	1196	74
11	54	3		992	1132	1033	1179	1073	1227	107
12	60	3		1020	1164	1060	1211	1101	1259	102
13	64	4		1186	1357	1240	1420	1294	1483	99
14	68	4		1212	1387	1266	1450	1320	1513	136
15	74	4		1239	1419	1293	1482	1347	1545	131
16	78	4		1265	1450	1319	1513	1373	1576	128
17	84	4		1292	1482	1346	1545	1400	1608	123
18	88	4		1318	1512	1372	1575	1426	1638	148
^ reduction per wall socket				217	242	231	258	244	273	

double rod

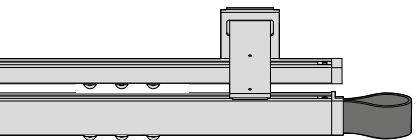

length → 3"

set-no. **Ambition** 03626

length (ft.)	rollers	brackets		bracket 3"		bracket 5"	
				A	B	A	B
3	32	2	\$	843	973	870	1005
4	40	3		1060	1226	1100	1273
5	48	3		1106	1282	1146	1330
6	60	3		1155	1342	1196	1390
7	68	3		1201	1399	1242	1446
8	80	4		1421	1654	1475	1718
9	88	4		1467	1711	1521	1774
• 10	100	4		1516	1771	1570	1834
11	108	4		1563	1828	1617	1891
12	120	5		1782	2083	1850	2162
13	128	5		1828	2140	1896	2219
14	136	5		1874	2197	1942	2276
15	148	5		1924	2257	1991	2336
16	156	6		2140	2509	2221	2604
17	168	6		2189	2569	2270	2664
18	176	6		2236	2625	2317	2720
^ reduction per wall socket				229	260	242	276

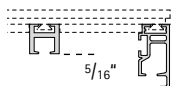

Notes





larger base plate + \$ 18.00 per bracket

^ position wall socket left/right, please specify

• rods in excess of 9ft. will be delivered in two sections

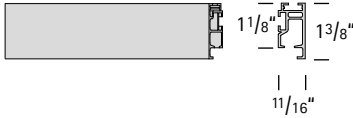
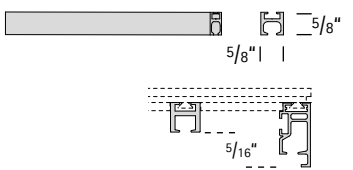

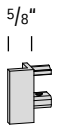
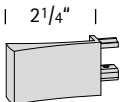
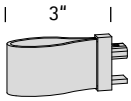
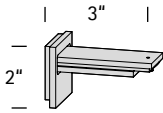
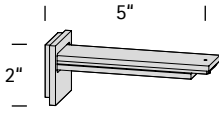
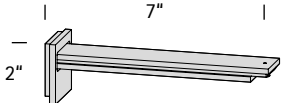



traversing geometric flat 1 3/8"

components	part	part-no.	color-no.	price	
	traversing rod flat 1 3/8" material: aluminium	36770	77 79	stainless steel aluminium Cut to measure \$ / lin ft. 27.30 22.60	
	traversing rod 5/8" x 5/8" square for double rod material: aluminium	17970	77 79	stainless steel aluminium Cut to measure \$ / lin ft. 23.00 17.20	
	end cap square for second rod for 17970	17929	77 79	stainless steel aluminium 49.50 38.30	
	finial Dimension	right left	36701 36702	77 78 79 77 79	stainless steel polished aluminium aluminium stainless steel aluminium 54.00 54.00 54.00 101.00 87.80
	finial Vision	right left	36703 36704	77 79 77 79	stainless steel aluminium stainless steel aluminium 149.70 149.70 149.70 137.30 137.30 137.30
	finial Ambition	right left	36771 36772	77/52 77/56 77/57 79/52 79/56 79/57	stainless steel/brown stainless steel/black stainless steel/cognac aluminium/brown aluminium/black aluminium/cognac 149.70 149.70 149.70 137.30 137.30 137.30
	bracket 3"		36711	77 79	stainless steel aluminium 161.90 140.70
	bracket 5"		36712	77 79	stainless steel aluminium 177.60 154.20
	bracket 7"		36713	77 79	stainless steel aluminium 193.40 167.70

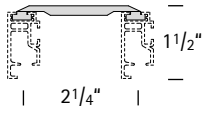
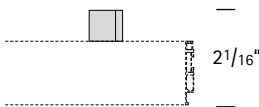
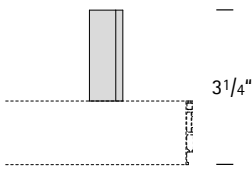

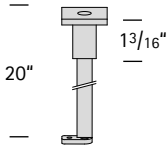
traversing geometric flat 1 3/8"

components	part	part-no.	color-no.	price	
	double bracket 3"	36721	77 79	stainless steel aluminium	195.60 170.00
	double bracket 5"	36722	77 79	stainless steel aluminium	211.40 183.50
	larger base plate e.g. 36712X	X			surcharge 18.00
	shorten bracket e.g. 36722-77-S-4"	S			surcharge 64.00
	wall socket can be used at both ends for 36770	36705	77 79	stainless steel aluminium	69.80 60.80
	wall socket can be used at both ends for hidden mount for 36770	36707	50	white	54.00
	wall socket can be used at both ends for 17970	17905	77 79	stainless steel aluminium	65.30 56.30
	ceiling bracket for hidden mount shadow gap adjustable 0 - 3/8"	36615	50	white	51.30

traversing geometric flat 1 3/8"

components	part	part-no.	color-no.	price	
	ceiling bracket close to ceiling for double rod shadow gap 1/8"	30524	50 79	white aluminium	33.30 33.30
	ceiling bracket 3/4" square	17914	77 79	stainless steel aluminium	85.50 74.30
	ceiling bracket 2" square	17916	77 79	stainless steel aluminium	103.50 88.90
	extension piece 3/4" for brackets 17914, 17916	17917	77 79	stainless steel aluminium	38.30 33.80
	ceiling bracket 20", can be shortened square	21715	77 79	stainless steel aluminium	198.10 165.40
	roller with eyelet	30082	50	white	0.80
	curtain hook	30080	50	white	0.20
	runner for batons can be retrofitted	30078	50	white	3.60

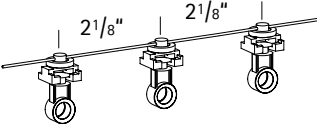
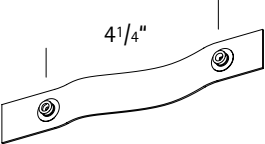
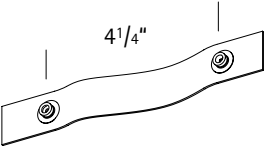
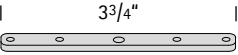
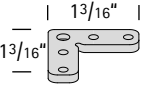
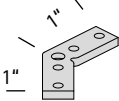
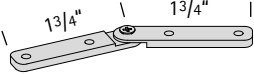
traversing geometric flat 1 3/8"

components	part	part-no.	color-no.	price
	stop clamp	30089	50 white	1.80
	carriers with cord spacing between carriers 2 1/8" with easy snap for convenient installation	40 pcs 29085/40 60 pcs 29085/60 80 pcs 29085/80 100 pcs 29085/100 120 pcs 29085/120	50 white 50 white 50 white 50 white 50 white	52.00 78.00 104.00 130.00 156.00
	ripplefold tape spacing between buttons 4 1/4" 100 % fullness spool 100 yards	29012	50 white 11 transparent	413.60 413.60
	ripplefold tape spacing between buttons 4 1/4" 100 % fullness cut to measure	29010	50 white 11 transparent	per lin. ft. 1.70 per lin. ft. 1.70
	connector	30578	99	16.90
	corner connector 90° mitre cut \$ 43.00	30550	99	25.90
	corner connector 135° mitre cut \$ 43.00	30551	99	30.40
	corner connector flexible mitre cut \$ 43.00	30552	99	59.70
	batons		see page 275	
	accessories		see page 276	



show aluminium/polished aluminium



spot aluminium/polished aluminium



event aluminium/polished aluminium



finishes available



77 stainless steel 79 aluminium

star 79 aluminium (end cap plastic)

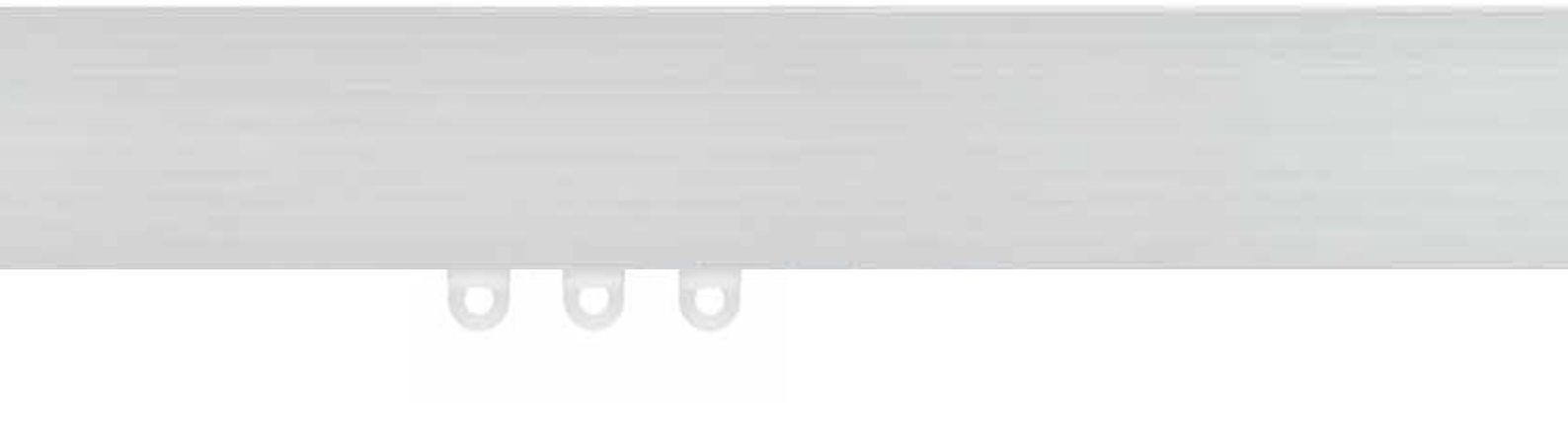

cult 77 stainless steel (end cap aluminium)



scale 1:1



traversing geometric flat 1 3/8"

finishes available

- A 79 aluminium
- B 77 stainless steel

material: aluminium (end cap plastic)

single rod



length \rightarrow $\frac{1}{8}$ "

set-no.

Star 03601

length (ft.)	rollers	brackets		bracket 3"		bracket 5"		bracket 7"		ripplefold surcharge
				A	B	A	B	A	B	
3	16	2	\$	378	430	405	462	432	493	61
4	20	2		402	458	429	489	456	521	58
5	24	2		427	486	454	517	481	549	54
6	30	2		453	515	480	547	507	578	50
7	34	3		618	705	658	752	699	800	87
8	40	3		644	735	684	782	725	829	82
9	44	3		668	763	709	810	749	857	79
10	50	3		695	792	735	839	776	887	74
11	54	3		719	820	760	867	800	915	107
12	60	3		745	850	786	897	826	944	102
13	64	4		910	1039	964	1102	1018	1165	99
14	68	4		935	1067	989	1130	1043	1193	136
15	74	4		961	1097	1015	1160	1069	1223	131
16	78	4		985	1125	1039	1187	1093	1251	128
17	84	4		1012	1154	1066	1217	1120	1280	123
18	88	4		1036	1182	1090	1245	1144	1308	148
reduction per wall socket				88	100	101	116	115	132	

double rod



length \rightarrow $\frac{1}{8}$ "

set-no.

Star 03605

length (ft.)	rollers	brackets		bracket 3"		bracket 5"	
				A	B	A	B
3	32	2	\$	532	604	559	635
4	40	2		581	660	608	691
5	48	2		630	715	657	747
6	60	2		682	774	709	806
7	68	3		901	1026	942	1073
8	80	3		954	1085	994	1132
9	88	3		1003	1141	1043	1188
10	100	3		1055	1200	1095	1247
11	108	3		1104	1255	1144	1303
12	120	3		1156	1314	1197	1362
13	128	4		1375	1566	1429	1629
14	136	4		1424	1622	1478	1685
15	148	4		1476	1681	1530	1744
16	156	4		1525	1736	1579	1800
17	168	4		1577	1795	1631	1859
18	176	4		1626	1851	1680	1914
reduction per wall socket				64	72	78	88

Notes



larger base plate + \$ 18.00 per bracket

• rods in excess of 9ft. will be delivered in two sections



accessories see page 276

traversing geometric flat 1³/₈"

finishes available

material: aluminium

A 79 aluminium

B 77 stainless steel

single rod



length 1/4"

set-no.

Cult 03609

length (ft.)	rollers	brackets		bracket 3"		bracket 5"		bracket 7"		ripplefold surcharge	
				A	B	A	B	A	B		
3	16	2	\$	450	516	477	547	504	579	61	
4	20	2		474	544	501	575	528	607	58	
5	24	2		499	572	526	603	553	635	54	
6	30	2		525	601	552	632	579	664	50	
7	34	3		690	791	730	838	771	885	87	
8	40	3		716	820	756	867	797	915	82	
9	44	3		740	848	781	895	821	943	79	
10	50	3	•	767	878	807	925	848	972	74	
11	54	3		791	906	832	953	872	1000	107	
12	60	3		817	935	858	982	898	1030	102	
13	64	4		982	1125	1036	1188	1090	1251	99	
14	68	4		1007	1153	1061	1216	1115	1279	136	
15	74	4		1033	1182	1087	1245	1141	1308	131	
16	78	4		1057	1210	1111	1273	1165	1336	128	
17	84	4		1084	1240	1138	1303	1192	1366	123	
18	88	4		1108	1268	1162	1330	1216	1394	148	
reduction per wall socket					124	143	137	159	151	174	

double rod



length 1/4"

set-no.

Cult 03610

length (ft.)	rollers	brackets		bracket 3"		bracket 5"			
				A	B	A	B		
3	32	2	\$	676	775	703	807		
4	40	2		725	831	752	862		
5	48	2		774	887	801	918		
6	60	2		826	946	853	977		
7	68	3		1045	1197	1086	1244		
8	80	3		1098	1256	1138	1303		
9	88	3		1147	1312	1187	1359		
10	100	3	•	1199	1371	1239	1418		
11	108	3		1248	1427	1288	1474		
12	120	3		1300	1486	1341	1533		
13	128	4		1519	1737	1573	1800		
14	136	4		1568	1793	1622	1856		
15	148	4		1620	1852	1674	1915		
16	156	4		1669	1908	1723	1971		
17	168	4		1721	1967	1775	2030		
18	176	4		1770	2022	1824	2086		
reduction per wall socket					136	157	150	173	

Notes



larger base plate + \$ 18.00 per bracket

• rods in excess of 9ft. will be delivered in two sections

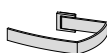

accessories see page 276

components see page 106

finishes available



77 stainless steel 79 aluminium

show 79/28 aluminium/wengé



spot 79/78 aluminium/polished aluminium



event 77/78 stainless steel/polished aluminium



finials show



79 aluminium



78 polished aluminium



28 wengé

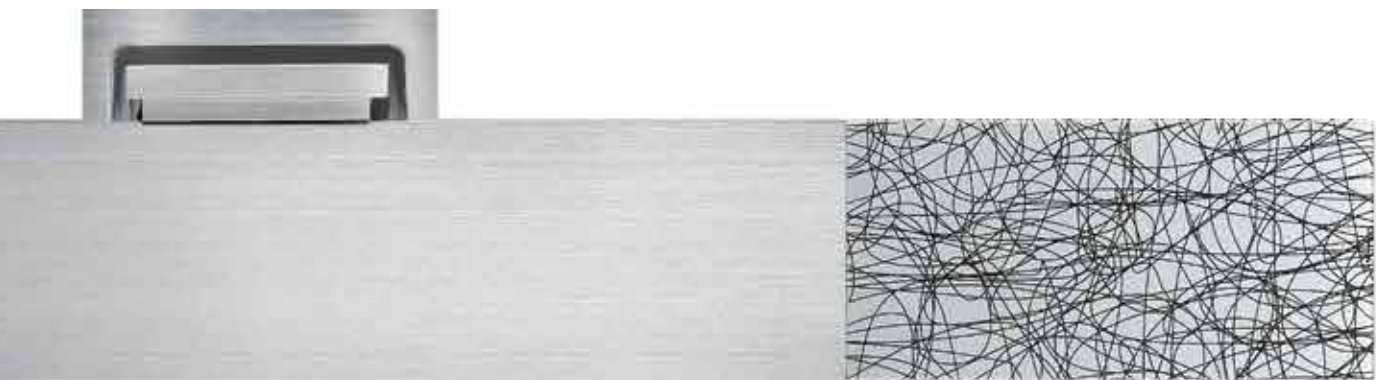
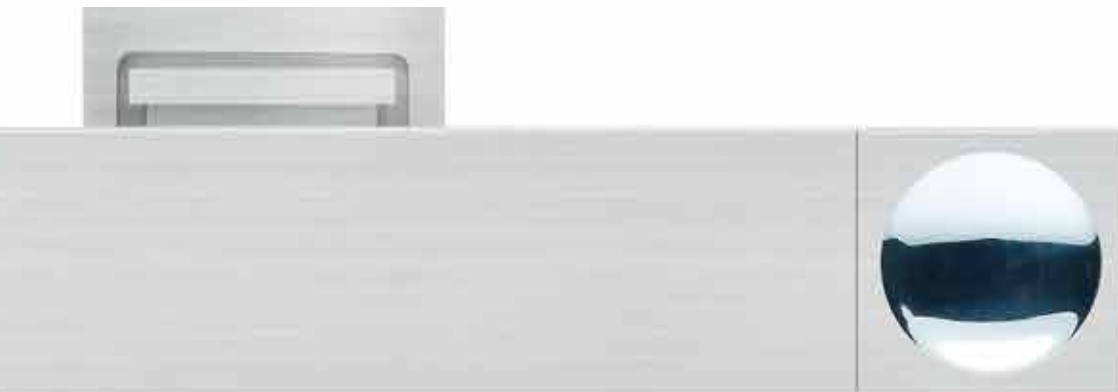

(finial with print art)

traversing geometric flat 1 3/8"

finishes available

A	79	aluminium
	79/28	aluminium/wengé
	79/78	aluminium/polished aluminium

material: aluminium, finials with wood

B	77	stainless steel
	77/28	stainless steel/wengé
	77/78	stainless steel/polished aluminium

single rod

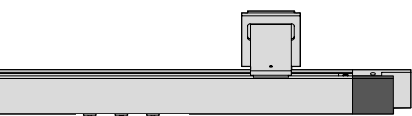

length → 2" |

Show 03602

length (ft.)	rollers	brackets		bracket 3"		bracket 5"		bracket 7"		ripplefold surcharge
				A	B	A	B	A	B	
3	16	2	\$	578	652	605	684	632	715	61
4	20	2		603	680	630	711	657	743	58
5	24	2		627	708	654	739	681	771	54
6	30	2		653	737	680	769	707	800	50
7	34	3		819	927	859	974	900	1022	87
8	40	3		845	957	885	1004	926	1051	82
9	44	3		869	985	910	1032	950	1079	79
• 10	50	3		895	1014	936	1061	976	1109	74
11	54	3		920	1042	960	1089	1001	1137	107
12	60	3		946	1072	986	1119	1027	1166	102
13	64	4		1111	1261	1165	1324	1219	1387	99
set-no. 14	68	4		1136	1289	1190	1352	1244	1415	136
15	74	4		1162	1319	1216	1382	1270	1445	131
16	78	4		1186	1347	1240	1409	1294	1473	128
17	84	4		1212	1376	1266	1439	1320	1502	123
18	88	4		1237	1404	1291	1467	1345	1530	148
^ reduction per wall socket				188	211	202	227	215	243	

double rod

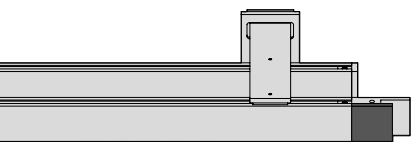

length → 2" |

Show 03606

length (ft.)	rollers	brackets		bracket 3" 3" 2 1/4"		bracket 5" 5" 2 1/4"	
				A	B	A	B
3	32	2	\$	733	826	760	857
4	40	2		782	882	809	913
5	48	2		831	937	858	969
6	60	2		883	996	910	1028
7	68	3		1102	1248	1143	1295
8	80	3		1154	1307	1195	1354
9	88	3		1203	1363	1244	1410
• 10	100	3		1256	1422	1296	1469
11	108	3		1305	1477	1345	1525
12	120	3		1357	1536	1397	1584
13	128	4		1576	1788	1630	1851
set-no. 14	136	4		1625	1844	1679	1907
15	148	4		1677	1903	1731	1966
16	156	4		1726	1958	1780	2022
17	168	4		1778	2017	1832	2081
18	176	4		1827	2073	1881	2136
^ reduction per wall socket				165	183	178	199

Notes



larger base plate + \$ 18.00 per bracket

^ position wall socket left/right, please specify

• rods in excess of 9ft. will be delivered in two sections

traversing geometric flat 1 3/8"

finishes available

A 79/78 aluminium/polished aluminium

B 77/78 stainless steel/polished aluminium

material: aluminium (final Event with print art)

single rod

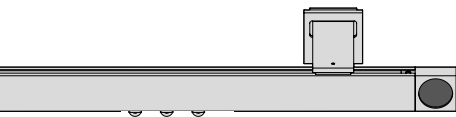

length →

set-no.

Spot 03603

Event 03604

length (ft.)	rollers	brackets		bracket 3"		bracket 5"		bracket 7"		ripplefold surcharge
				A	B	A	B	A	B	
3	16	2	\$	614	667	641	698	668	730	61
4	20	2		638	694	665	726	692	757	58
5	24	2		663	722	690	754	717	785	54
6	30	2		689	752	716	783	743	815	50
7	34	3		854	942	895	989	935	1036	87
8	40	3		880	971	921	1018	961	1066	82
9	44	3		905	999	945	1046	986	1094	79
• 10	50	3		931	1029	971	1076	1012	1123	74
11	54	3		955	1056	996	1104	1036	1151	107
12	60	3		982	1086	1022	1133	1063	1180	102
13	64	4		1147	1276	1201	1339	1255	1402	99
14	68	4		1171	1304	1225	1366	1279	1430	136
15	74	4		1197	1333	1251	1396	1305	1459	131
16	78	4		1222	1361	1276	1424	1330	1487	128
17	84	4		1248	1391	1302	1453	1356	1517	123
18	88	4		1272	1418	1326	1481	1380	1544	148
^reduction per wall socket				206	218	220	234	233	250	

double rod



length →

set-no.

Spot 03607

Event 03608

length (ft.)	rollers	brackets		bracket 3"		bracket 5"	
				A	B	A	B
3	32	2	\$	769	840	796	872
4	40	2		818	896	845	928
5	48	2		867	952	894	983
6	60	2		919	1011	946	1042
7	68	3		1138	1262	1178	1310
8	80	3		1190	1321	1231	1369
9	88	3		1239	1377	1280	1424
• 10	100	3		1291	1436	1332	1483
11	108	3		1340	1492	1381	1539
12	120	3		1392	1551	1433	1598
13	128	4		1611	1802	1665	1865
14	136	4		1660	1858	1714	1921
15	148	4		1713	1917	1767	1980
16	156	4		1762	1973	1816	2036
17	168	4		1814	2032	1868	2095
18	176	4		1863	2088	1917	2151
^reduction per wall socket				182	190	196	206

Notes







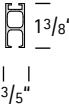

larger base plate + \$ 18.00 per bracket

^ position wall socket left/right, please specify

• rods in excess of 9ft. will be delivered in two sections

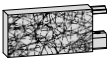

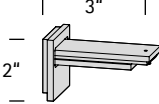
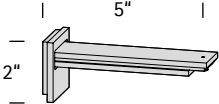
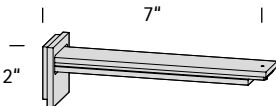

traversing geometric flat 1³/₈"

components	part	part-no.	color-no.	price
	 1 ³ / ₈ " 3/5"	traversing rod flat 1³/₈"		Cut to measure \$ / lin. ft.
		material: aluminium		
	finial Cult	36873	77 stainless steel	50.70
			79 aluminium	43.90
 color-no. 2 color-no. 1	finial Show	right	36801 77 stainless steel	118.90
			77/28 stainless steel/wengé	118.90
		left	36802 77/78 stainless steel/pol. aluminium	118.90
			79 aluminium	108.30
			79/28 aluminium/wengé	108.30
79/78 aluminium/polished aluminium	108.30			
 color-no. 1 color-no. 2	finial Spot	right	36803 77/78 stainless steel/pol. aluminium	126.10
			79/78 aluminium/polished aluminium	126.10
		left	36804	
	finial Event	36871	78 polished aluminium (with print art)	126.10
	end cap Star plastic	36829 77 stainless steel	7.90	
			79 aluminium	7.90
	bracket 3"	36711 77 stainless steel	161.90	
			79 aluminium	140.70
	bracket 5"	36712 77 stainless steel	177.60	
			79 aluminium	154.20
	bracket 7"	36713 77 stainless steel	193.40	
			79 aluminium	167.70

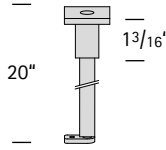

traversing geometric flat 1 3/8"

components	part	part-no.	color-no.	price	
	double bracket 3"	36721	77 79	stainless steel aluminium	195.60 170.00
	double bracket 5"	36722	77 79	stainless steel aluminium	211.40 183.50
	larger base plate e.g. 36712X	X			surcharge 18.00
	shorten bracket e.g. 36722-77-S-4"	S			surcharge 64.00
	wall socket can be used at both ends	36805	77 79	stainless steel aluminium	69.80 60.80
		ceiling bracket close to ceiling shadow gap 1/8"	30514	50 79	white aluminium
	ceiling bracket close to ceiling for double rod shadow gap 1/8"	30524	50 79	white aluminium	33.30 33.30
	ceiling bracket 3/4" square	17914	77 79	stainless steel aluminium	85.50 74.30
	ceiling bracket 2" square	17916	77 79	stainless steel aluminium	103.50 88.90

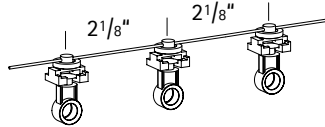
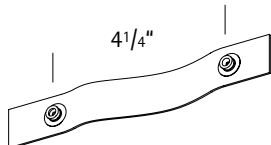
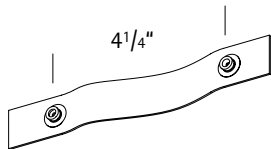
traversing geometric flat 1³/₈"

components	part	part-no.	color-no.	price		
	extension piece 3/4" for brackets 17914, 17916	17917	77 79	stainless steel aluminium	38.30 33.80	
	ceiling bracket 20", can be shortened square	21715	77 79	stainless steel aluminium	198.10 165.40	
	roller with eyelet	30082	50	white	0.80	
	curtain hook	30080	50	white	0.20	
	runner for batons can be retrofitted	30078	50	white	3.60	
	stop clamp	30089	50	white	1.80	
	carriers with cord spacing between carriers 2 ¹ / ₈ " with easy snap for convenient installation	40 pcs 60 pcs 80 pcs 100 pcs 120 pcs	29085/40 29085/60 29085/80 29085/100 29085/120	50 50 50 50 50	white white white white white	52.00 78.00 104.00 130.00 156.00
	ripplefold tape spacing between buttons 4 ¹ / ₄ " 100 % fullness	29012	50 11	white transparent	413.60 413.60	
	ripplefold tape spacing between buttons 4 ¹ / ₄ " 100 % fullness cut to measure	29010	50 11	white transparent	per lin. ft. 1.70 per lin. ft. 1.70	

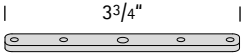
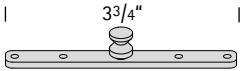
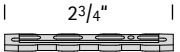
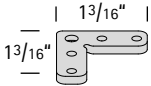
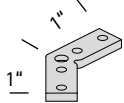
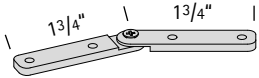
traversing geometric flat 1³/₈"

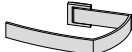
components	part	part-no.	color-no.	price
	connector for brackets 36711-36722	30578	99	16.90
	connector for ceiling brackets 17914, 17916	30577	99	16.90
	connector for brackets 30514, 30524 (plastic)	21719	99	13.50
	corner connector 90° mitre cut \$ 43.00	30550	99	25.90
	corner connector 135° mitre cut \$ 43.00	30551	99	30.40
	corner connector flexible mitre cut \$ 43.00	30552	99	59.70
	batons			see page 275
	accessories			see page 276

page 112



page 120

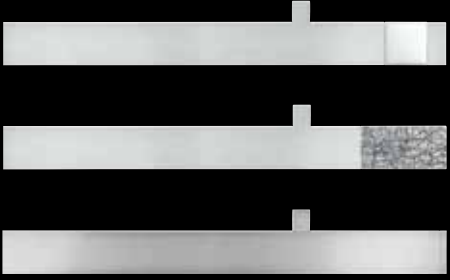

traversing
geometric

flat 1 3/8"

ceiling

sphere stainless steel





50 white



56 black



62 brushed brass



70 chromium



72 brushed nickel



77 stainless steel



79 aluminium



80 antique bronzed

finishes available

sphere 79 aluminium



sphere 77 stainless steel



sphere 56 black



scale 1:1

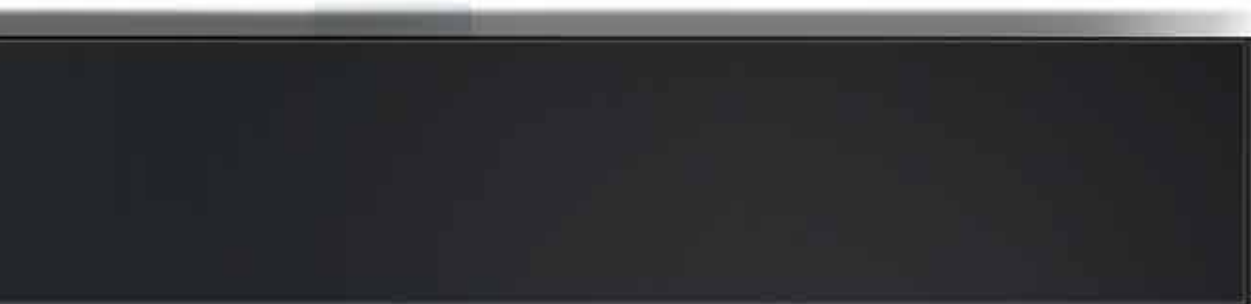
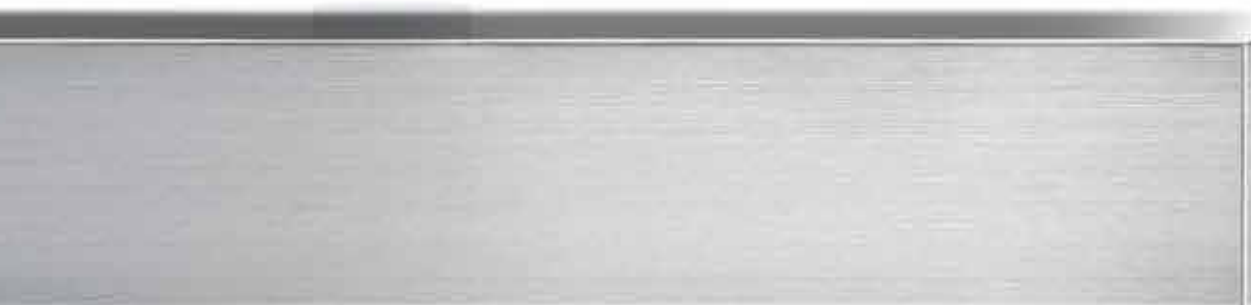

traversing geometric flat 1 3/8"

finishes available

- A** 50 white
56 black
79 aluminium

- B** 62 brushed brass
72 brushed nickel
77 stainless steel
80 antique bronzed
C 70 chromium

material: aluminium

single rod

length rollers brackets

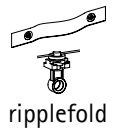
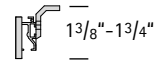

length ending 3/4"

- Sphere** set-no.
freestanding (ending both sides) 03691*
wall contact left side (ending right side only) 03692
wall contact right side (ending left side only) 03693
wall to wall 03694

(ft.)				A	B	C	surcharge
3	16	2	\$	315	329	384	61
4	20	2		341	359	433	58
5	24	2		366	390	481	54
6	30	3		445	473	583	50
7	34	3		471	504	632	87
8	40	3		498	536	682	82
9	44	3		524	566	731	79
• 10	50	3		552	599	782	74
11	54	4		629	680	882	107
12	60	4		656	712	932	102
13	64	4		682	743	981	99
14	68	4		708	773	1030	136
15	74	4		735	806	1080	131
16	78	4		761	836	1129	128
17	84	5		840	919	1231	123
18	88	5		865	950	1279	148
reduction per wall contact				64	64	64	

Notes

- * rod with ending on both sides cannot be shortened
- rods in excess of 9ft. will be delivered in two sections

components

part

part-no. color-no.

price:

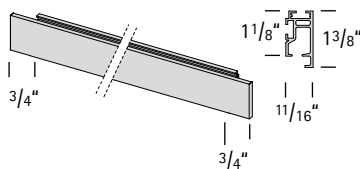

traversing rod flat 1 3/8"
with ending 3/4" both sides
cannot be shortened

36780

- 50 white
56 black
62 brushed brass
70 chromium
72 brushed nickel
77 stainless steel
79 aluminium
80 antique bronzed

material: aluminium

price	price
Cut to measure \$ / lin ft. 22.60	} + \$ 114.00
22.60	
27.30	
45.60	
27.30	
27.30	
22.60	
27.30	

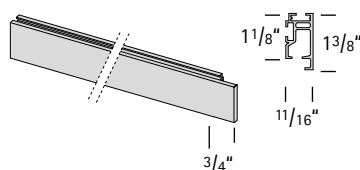

traversing rod flat 1 3/8"
with ending 3/4" right side
wall contact left side

36781

- 50 white
56 black
62 brushed brass
70 chromium
72 brushed nickel
77 stainless steel
79 aluminium
80 antique bronzed







material: aluminium

price	price
Cut to measure \$ / lin ft. 22.60	} + \$ 57.00
22.60	
27.30	
45.60	
27.30	
27.30	
22.60	
27.30	

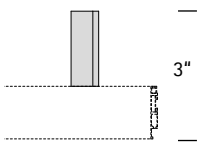

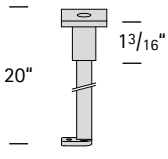

traversing geometric flat 1 3/8"

components	part	part-no.	color-no.	price		
	traversing rod flat 1 3/8" with ending 3/4" left side wall contact right side material: aluminium	36782	50 white	Cut to measure \$ / lin ft. 22.60 22.60 27.30 45.60 27.30 27.30 22.60 27.30		
			56 black			
			62 brushed brass			
			70 chromium			
			72 brushed nickel			
			77 stainless steel			
			79 aluminium			
			80 antique bronzed			
				+ \$ 57.00		
	traversing rod flat 1 3/8" for wall contact both sides material: aluminium	36770	50 white	Cut to measure \$ / lin ft. 22.60 22.60 27.30 45.60 27.30 27.30 22.60 27.30		
			56 black			
			62 brushed brass			
			70 chromium			
			72 brushed nickel			
			77 stainless steel			
			79 aluminium			
			80 antique bronzed			
	end cap for cut with ending 3/4"	right	36788	50 white	7.00	
		left	36789	56 black	7.00	
					62 brushed brass	7.00
					70 chromium	7.00
					72 brushed nickel	7.00
					77 stainless steel	7.00
					79 aluminium	7.00
					80 antique bronzed	7.00
	wall socket can be used at both ends for hidden mount only for cut without ending	36707	50	white	54.00	
	ceiling bracket Sphere for hidden mount shadow gap adjustable 0 - 3/8"	36615	50	white	51.30	
	ceiling bracket close to ceiling for double rod shadow gap 1/8"	30524	50	white	33.30	
			79	aluminium	33.30	
	ceiling bracket 3/4" square	17914	50	white	74.30	
			56	black	74.30	
			62	brushed brass	85.50	
			70	chromium	101.30	
			72	brushed nickel	85.50	
			77	stainless steel	85.50	
			79	aluminium	74.30	
			80	antique bronzed	85.50	

traversing geometric flat 1³/₈"

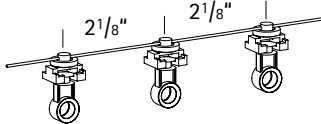
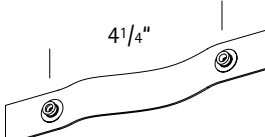
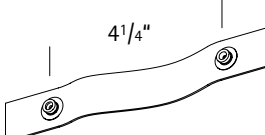
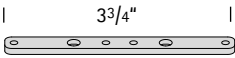
components	part	part-no.	color-no.	price
	ceiling bracket 2" square	17916	50 white	88.90
			56 black	88.90
			62 brushed brass	103.50
			70 chromium	120.40
			72 brushed nickel	103.50
			77 stainless steel	103.50
			79 aluminium	88.90
			80 antique bronzed	103.50
	extension piece 3/4" for brackets 17914, 17916	17917	50 white	33.80
			56 black	33.80
			62 brushed brass	38.30
			70 chromium	44.60
			72 brushed nickel	38.30
			77 stainless steel	38.30
			79 aluminium	33.80
			80 antique bronzed	38.30
	ceiling bracket 20", can be shortened square	21715	50 white	165.40
			56 black	165.40
			62 brushed brass	198.10
			70 chromium	258.90
			72 brushed nickel	198.10
			77 stainless steel	198.10
			79 aluminium	165.40
			80 antique bronzed	198.10
	roller with eyelet	30082	50 white	0.80
	curtain hook	30080	50 white	0.20
	runner for batons can be retrofitted	30078	50 white	3.60
	stop clamp	30089	50 white	1.80

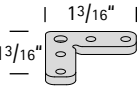
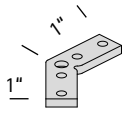
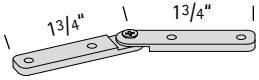
traversing geometric flat 1 3/8"

components	part	part-no.	color-no.	price
	carriers with cord	40 pcs	29085/40 50	white 52.00
	spacing between	60 pcs	29085/60 50	white 78.00
	carriers 2 1/8"	80 pcs	29085/80 50	white 104.00
		100 pcs	29085/100 50	white 130.00
	with easy snap for convenient installation	120 pcs	29085/120 50	white 156.00
	ripplefold tape	29012	50	white 413.60
	spacing between buttons 4 1/4" 100 % fullness		11	transparent 413.60
spool 100 yards				
	ripplefold tape	29010	50	white per lin. ft. 1.70
	spacing between buttons 4 1/4" 100 % fullness		11	transparent per lin. ft. 1.70
cut to measure				
	connector	30579	99	16.90
for bracket 36615				
	connector	30577	99	16.90
for ceiling brackets 17914, 17916				
	corner connector	30550	99	25.90
90° mitre cut \$ 43.00				
	corner connector	30551	99	30.40
135° mitre cut \$ 43.00				
	corner connector	30552	99	59.70
flexible mitre cut \$ 43.00				
	batons			see page 275
	accessories			see page 276

cubus 35 aluminium



finishes available



77 stainless steel



79 aluminium

cubus 35
with finial Show

79 aluminium



cubus 35
with finial Event

79 aluminium



cubus 35
with finial Cult

77 stainless steel



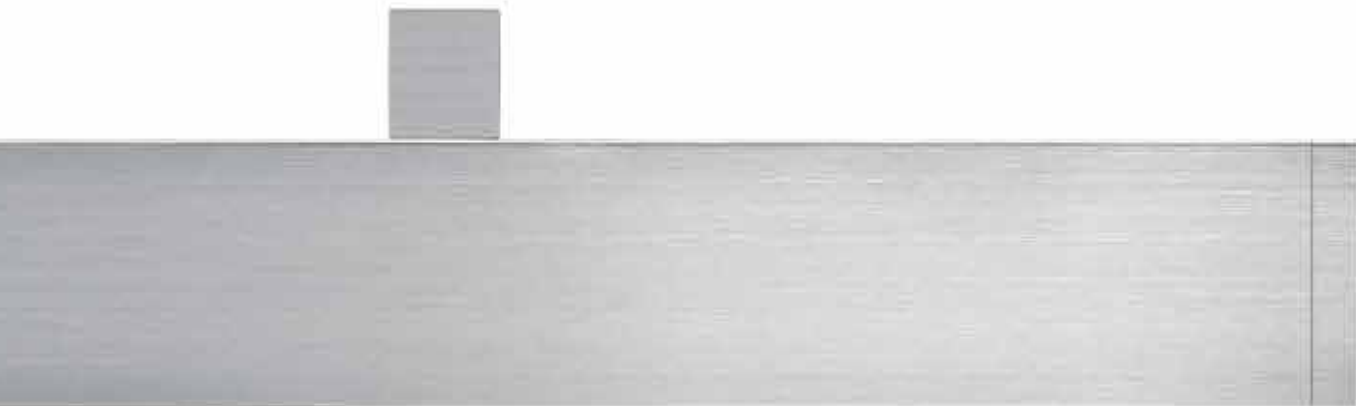
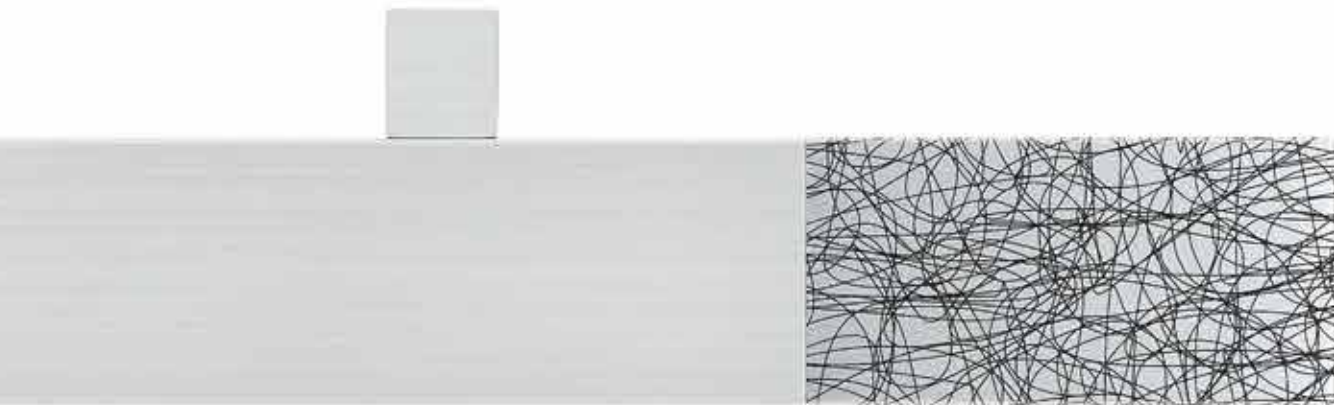

traversing geometric flat 1 3/8"

finishes available

- A 79 aluminium
- B 77 stainless steel

material: aluminium

single rod



length →

set-no.

Cubus 35 03619

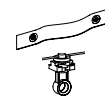
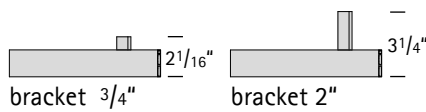

ripplefold

length (ft.)	rollers	brackets		bracket 3/4"		bracket 2"		surcharge
				A	B	A	B	
3	16	2	\$	229	262	258	298	61
4	20	2		253	289	283	325	58
5	24	2		278	317	307	353	54
6	30	3		378	432	422	486	50
7	34	3		403	460	447	514	87
8	40	3		429	490	473	544	82
9	44	3		453	518	497	572	79
• 10	50	3		480	547	523	601	74
11	54	4		578	661	637	733	107
12	60	4		604	690	663	762	102
13	64	4		629	718	687	790	99
14	68	4		653	746	712	818	136
15	74	4		680	775	738	847	131
16	78	4		704	803	762	875	128
17	84	5		804	918	877	1008	123
18	88	5		829	946	902	1036	148

set without
finials
finials see
below







Notes

- rods in excess of 9ft. will be delivered in two sections

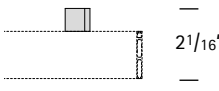
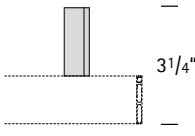

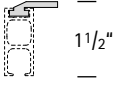
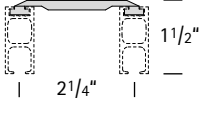
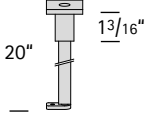

components

part	part-no.	color-no.	price
	36870	77 stainless steel	24.70
		79 aluminium	21.30
	36873	77 stainless steel	50.70
		79 aluminium	43.90
	36801	77 stainless steel	118.90
		77/28 stainless steel/wengé	118.90
		77/78 stainless steel/pol. aluminium	118.90
		79 aluminium	108.30
		79/28 aluminium/wengé	108.30
		79/78 aluminium/polished aluminium	108.30
	36803	77/78 stainless steel/pol. aluminium	126.10
		79/78 aluminium/polished aluminium	126.10
		77/78 stainless steel/pol. aluminium	126.10
		79/78 aluminium/polished aluminium	126.10
	36871	78 polished aluminium (with print art)	126.10

traversing geometric flat 1 3/8"

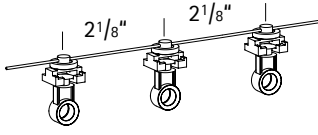
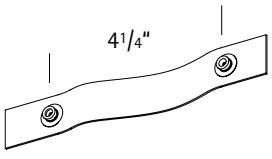
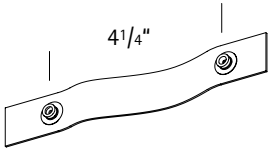
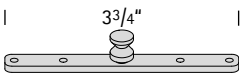
components	part	part-no.	color-no.	price	
	end cap Star plastic	36829	77 79	stainless steel aluminium	7.90 7.90
	ceiling bracket Cubus 3/4" square	17914	77 79	stainless steel aluminium	85.50 74.30
	ceiling bracket Cubus 2" square	17916	77 79	stainless steel aluminium	103.50 88.90
	extension piece 3/4" for brackets 17914, 17916	17917	77 79	stainless steel aluminium	38.30 33.80
	ceiling bracket close to ceiling shadow gap 1/8"	30514	50 79	white aluminium	20.00 20.00
	ceiling bracket close to ceiling for double rod shadow gap 1/8"	30524	50 79	white aluminium	33.30 33.30
	ceiling bracket 20", can be shortened square	21715	77 79	stainless steel aluminium	198.10 165.40
	roller with eyelet	30082	50	white	0.80
	curtain hook	30080	50	white	0.20
	runner for batons can be retrofitted	30078	50	white	3.60
	stop clamp	30089	50	white	1.80

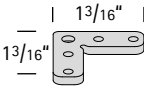
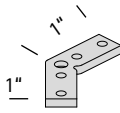
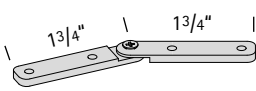
traversing geometric flat 1 3/8"

components	part	part-no.	color-no.	price	
	carriers with cord	40 pcs	29085/40 50	white	52.00
	spacing between	60 pcs	29085/60 50	white	78.00
	carriers 2 1/8"	80 pcs	29085/80 50	white	104.00
		100 pcs	29085/100 50	white	130.00
	with easy snap for convenient installation	120 pcs	29085/120 50	white	156.00
	ripplefold tape	29012	50	white	413.60
	spacing between buttons 4 1/4" 100 % fullness		11	transparent	413.60
	ripplefold tape	29010	50	white	per lin. ft. 1.70
	spacing between buttons 4 1/4" 100 % fullness		11	transparent	per lin. ft. 1.70
	connector	30577	99		16.90
	for bracket Cubus				
	connector	21719	99		13.50
	for brackets 30514, 30524 (plastic)				
	corner connector	30550	99		25.90
	90° mitre cut \$ 43.00				
	corner connector	30551	99		30.40
	135° mitre cut \$ 43.00				
	corner connector	30552	99		59.70
	flexible mitre cut \$ 43.00				
	batons			see page 275	
	accessories			see page 276	

page 126



page 154

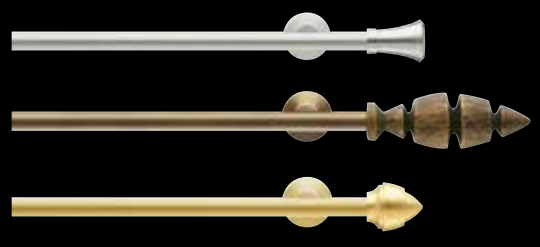

page 132

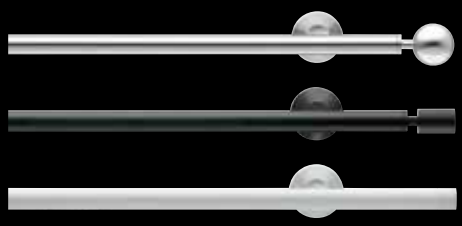

page 136

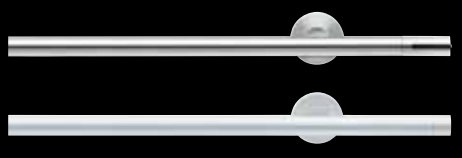

page 146

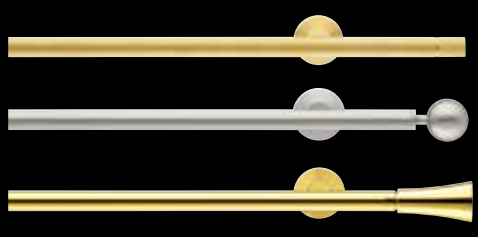

page 150

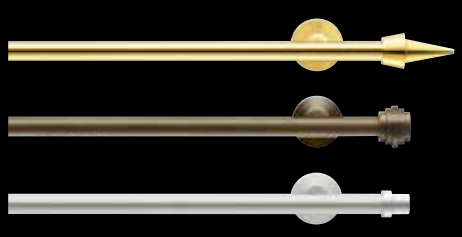

traversing
round

3/4"
dia.

traversing round $\frac{3}{4}$ " dia.



phantom 20 chromium



phantom 20 stainless steel

finishes available

70 chromium

77 stainless steel

79 aluminium

phantom 20 79 aluminium



scale 1:1

traversing round 3/4" dia.

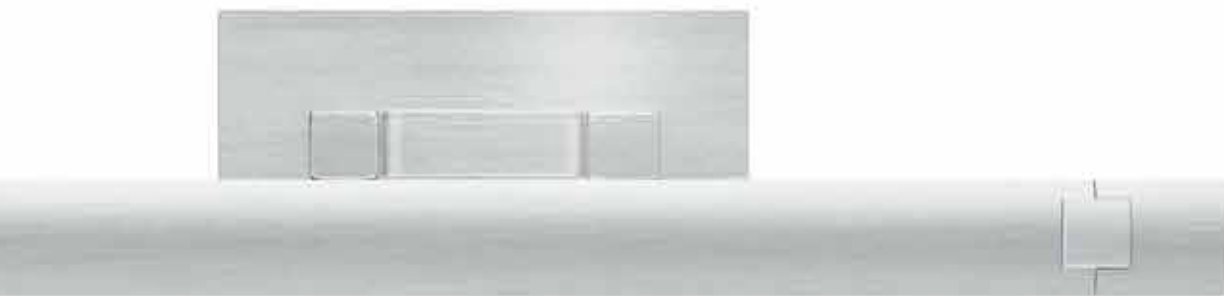

traversing round 3/4" dia.

finishes available

- A 79 aluminium
- B 77 stainless steel
- C 70 chromium

material: aluminium

single rod

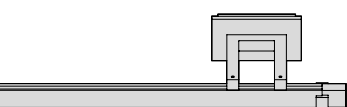

length → | 3/4" |

set-no. Phantom 20 02146

length (ft.)	rollers	brackets		bracket 3"			bracket 5"			ripplefold surcharge	
				A	B	C	A	B	C		
3	16	2	\$	504	593	727	554	644	797	61	
4	20	2		522	615	765	572	666	834	58	
5	24	3		690	814	1012	764	890	1116	54	
6	30	3		710	837	1051	784	914	1155	50	
7	34	3		728	859	1088	802	935	1192	87	
8	40	3		747	882	1127	821	959	1231	82	
9	44	4		915	1082	1374	1014	1183	1513	79	
10	50	4		934	1105	1413	1033	1207	1552	74	
11	54	4		952	1127	1450	1051	1228	1589	107	
12	60	4		972	1150	1489	1071	1252	1628	102	
13	64	4		990	1172	1527	1089	1273	1666	99	
14	68	5		1158	1371	1774	1281	1498	1947	136	
15	74	5		1177	1394	1813	1301	1521	1986	131	
16	78	5		1195	1416	1850	1319	1543	2024	128	
17	84	5		1215	1439	1889	1338	1566	2063	123	
18	88	5		1233	1461	1927	1356	1588	2100	148	
reduction per wall socket					172	198	232	197	223	267	

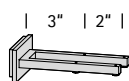

double rod

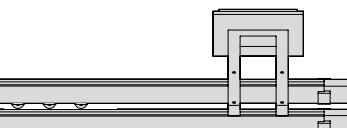

length → | 3/4" |

set-no. Phantom 20 02147

length (ft.)	rollers	brackets		bracket 3"			
				A	B	C	
3	32	2	\$	783	911	1134	
4	40	2		819	955	1209	
5	48	3		1042	1216	1542	
6	60	3		1082	1262	1620	
7	68	3		1118	1306	1695	
8	80	3		1157	1352	1773	
9	88	4		1380	1613	2107	
10	100	4		1419	1660	2185	
11	108	4		1455	1703	2260	
12	120	4		1494	1750	2338	
13	128	4		1530	1793	2412	
14	136	5		1753	2055	2746	
15	148	5		1792	2101	2824	
16	156	5		1828	2145	2899	
17	168	5		1867	2191	2977	
18	176	5		1903	2235	3052	
reduction per wall socket					232	258	304







Notes

- rods in excess of 9ft. will be delivered in two sections



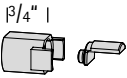
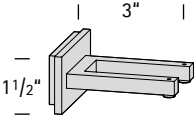
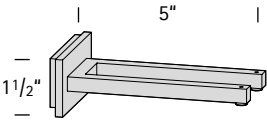
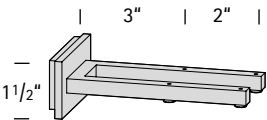
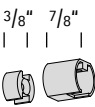
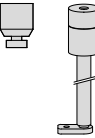

accessories see page 276

traversing round 3/4" dia.

components	part	part-no.	color-no.	price	
	 traversing rod 3/4" dia. material: aluminium	30570	70 77 79	chromium stainless steel aluminium	Cut to measure \$/ lin. ft. 34.20 18.50 14.80
	finial Phantom 20 also for double rod	21701	70 77 79	chromium stainless steel aluminium	94.50 83.00 72.00
	bracket Phantom 3"	21711	70 77 79	chromium stainless steel aluminium	209.60 177.60 149.70
	bracket Phantom 5"	21712	70 77 79	chromium stainless steel aluminium	244.30 203.00 174.40
	double bracket Phantom 3"	21721	70 77 79	chromium stainless steel aluminium	258.90 217.70 186.90
	wall socket can be used at both ends	21705	70 77 79	chromium stainless steel aluminium	72.00 63.00 49.50
	ceiling bracket			see page 142	
	roller with eyelet	30082	50	white	0.80
	curtain hook	30080	50	white	0.20
	runner for batons can be retrofitted	30078	50	white	3.60

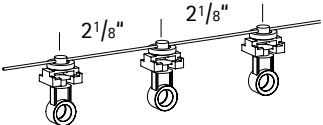
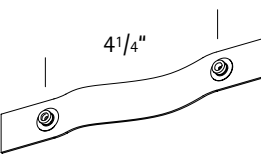
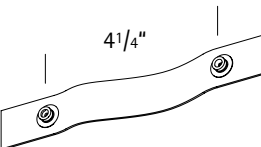
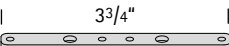
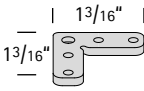
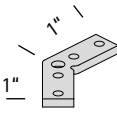
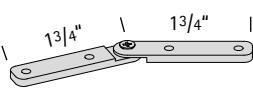
traversing round 3/4" dia.

components	part	part-no.	color-no.	price
	stop clamp	30089	50 white	1.80
	carriers with cord spacing between carriers 2 1/8"	40 pcs 29085/40 60 pcs 29085/60 80 pcs 29085/80 100 pcs 29085/100 120 pcs 29085/120	50 white 50 white 50 white 50 white 50 white	52.00 78.00 104.00 130.00 156.00
	with easy snap for convenient installation			
	ripplefold tape spacing between buttons 4 1/4" 100 % fullness	29012	50 white 11 transparent	413.60 413.60
	pool 100 yards			
	ripplefold tape spacing between buttons 4 1/4" 100 % fullness	29010	50 white 11 transparent	per lin. ft. 1.70 per lin. ft. 1.70
	cut to measure			
	connector	30579	99	16.90
	corner connector 90° mitre cut \$ 43.00	30550	99	25.90
	corner connector 135° mitre cut \$ 43.00	30551	99	30.40
	corner connector flexible mitre cut \$ 43.00	30552	99	59.70
	batons		see page 275	
	accessories		see page 276	

traversing round 3/4" dia.



duo aluminium/polished aluminium



retro stainless steel



metro chromium

50 white 56 black 70 chromium 77 stainless steel 79 aluminium

cosmo 77 stainless steel



retro 56 black



metro 79 Aluminium



scale 1:1



traversing round 3/4" dia.

finishes available

material: aluminium

- A 50 white
- 56 black
- 79 aluminium
- B 77 stainless steel
- C 70 chromium

single rod

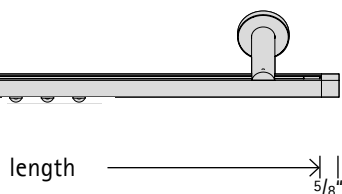

length $\frac{5}{8}$ "

set-no. **Metro** 02181

length (ft.)	rollers	brackets	\$	bracket 3"			bracket 5"			bracket 7"			ripplefold surcharge
				A	B	C	A	B	C	A	B	C	
3	16	2		284	329	449	302	349	474	324	375	506	61
4	20	2		302	350	487	320	371	512	342	397	543	58
5	24	3		398	461	633	425	492	670	458	531	718	54
6	30	3		417	485	672	444	516	709	478	555	757	50
7	34	3		435	506	709	462	537	747	496	576	794	87
8	40	3		455	530	748	482	561	786	516	600	833	82
9	44	4		550	641	894	586	682	944	632	734	1008	79
10	50	4		570	664	933	606	705	983	651	757	1047	74
11	54	4		588	686	971	624	727	1021	669	779	1084	107
12	60	4		608	709	1010	644	750	1060	689	802	1123	102
13	64	4		626	731	1047	662	772	1097	707	824	1160	99
14	68	5		721	842	1193	766	893	1256	823	958	1335	136
15	74	5		741	865	1232	786	917	1295	842	982	1374	131
16	78	5		759	887	1270	804	938	1332	860	1003	1411	128
17	84	5		779	910	1309	824	962	1371	880	1027	1450	123
18	88	5		797	932	1346	842	983	1409	898	1048	1488	148
reduction per wall socket				62	65	93	71	76	106	82	89	121	

double rod

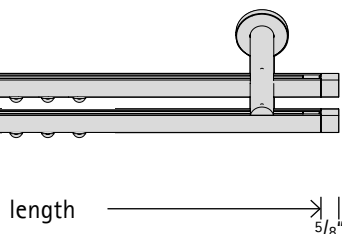

length $\frac{5}{8}$ "

set-no. **Metro** 02186

length (ft.)	rollers	brackets	\$	bracket 3"			bracket 5"			
				A	B	C	A	B	C	
3	32	2		455	528	741	477	553	772	
4	40	2		491	571	815	513	597	847	
5	48	3		626	729	1029	660	767	1076	
6	60	3		665	775	1107	699	814	1154	
7	68	3		701	819	1182	735	857	1229	
8	80	3		741	865	1260	774	904	1307	
9	88	4		876	1023	1473	920	1074	1536	
10	100	4		915	1069	1551	960	1121	1614	
11	108	4		951	1113	1626	996	1164	1689	
12	120	4		990	1159	1704	1035	1211	1767	
13	128	4		1026	1203	1779	1071	1254	1842	
14	136	5		1161	1360	1992	1217	1425	2071	
15	148	5		1200	1407	2070	1256	1471	2149	
16	156	5		1236	1450	2145	1292	1515	2224	
17	168	5		1276	1497	2223	1332	1561	2302	
18	176	5		1312	1540	2298	1368	1605	2376	
reduction per wall socket				68	66	107	79	79	123	

Notes

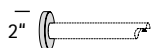

larger base plate + \$ 7.00 per bracket

- rods in excess of 9ft. will be delivered in two sections

traversing round 3/4" dia.

finishes available

material: aluminium

- A 50 white
- 56 black
- 79 aluminium
- B 77 stainless steel
- C 70 chromium

single rod

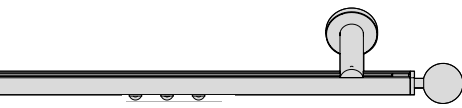

length →

- Cosmo** 02182
- Retro** 02183

length (ft.)	rollers	brackets		bracket 3"			bracket 5"			bracket 7"			ripplefold surcharge
				A	B	C	A	B	C	A	B	C	
3	16	2	\$	356	412	532	374	432	557	396	458	589	61
4	20	2		374	433	570	392	454	595	414	480	626	58
5	24	3		470	544	716	497	575	753	530	614	801	54
6	30	3		489	568	755	516	599	792	550	638	840	50
7	34	3		507	589	792	534	620	830	568	659	877	87
8	40	3		527	613	831	554	644	869	588	683	916	82
9	44	4		622	724	977	658	765	1027	704	817	1091	79
• 10	50	4		642	747	1016	678	788	1066	723	840	1130	74
11	54	4		660	769	1054	696	810	1104	741	862	1167	107
12	60	4		680	792	1093	716	833	1143	761	885	1206	102
13	64	4		698	814	1130	734	855	1180	779	907	1243	99
set-no.	14	68	5	793	925	1276	838	976	1339	895	1041	1418	136
	15	74	5	813	948	1315	858	1000	1378	914	1065	1457	131
	16	78	5	831	970	1353	876	1021	1415	932	1086	1494	128
	17	84	5	851	993	1392	896	1045	1454	952	1110	1533	123
	18	88	5	869	1015	1429	914	1066	1492	970	1131	1571	148
	reduction per wall socket			98	107	135	107	117	147	118	130	163	

double rod

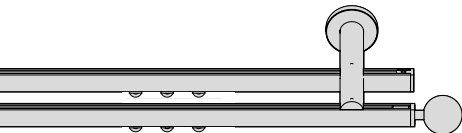

length →

- Cosmo** 02187
- Retro** 02188

length (ft.)	rollers	brackets		bracket 3"			bracket 5"		
				A	B	C	A	B	C
3	32	2	\$	471	544	722	493	570	754
4	40	2		507	588	797	529	613	829
5	48	3		642	745	1011	676	784	1058
6	60	3		681	792	1089	715	830	1136
7	68	3		717	835	1164	751	874	1211
8	80	3		756	882	1242	790	920	1289
9	88	4		891	1039	1455	936	1091	1518
• 10	100	4		931	1086	1533	975	1137	1596
11	108	4		967	1129	1608	1011	1181	1671
12	120	4		1006	1176	1686	1051	1227	1749
13	128	4		1042	1219	1761	1087	1271	1823
set-no.	14	136	5	1177	1377	1974	1233	1441	2053
	15	148	5	1216	1423	2052	1272	1488	2131
	16	156	5	1252	1467	2127	1308	1531	2205
	17	168	5	1291	1513	2205	1347	1578	2283
	18	176	5	1327	1557	2280	1383	1621	2358
	reduction per wall socket			76	74	98	87	87	114

Notes

larger base plate + \$ 7.00 per bracket

- rods in excess of 9ft. will be delivered in two sections

50 white 56 black 70 chromium 77 stainless steel 79 aluminium

duo 77/56 stainless steel/black



mono 50 white



scale 1:1

traversing round 3/4" dia.



traversing round 3/4" dia.

finishes available

material: aluminium (end cap plastic)

- A 50 white
- 56 black
- 79 aluminium
- B 77 stainless steel
- C 70 chromium

single rod

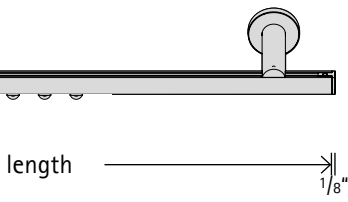

set-no. **Mono** 02180

length (ft.)	rollers	brackets		bracket 3"			bracket 5"			bracket 7"			ripplefold surcharge
				A	B	C	A	B	C	A	B	C	
3	16	2	\$	228	262	348	246	283	373	268	309	405	61
4	20	2		246	284	385	264	304	410	286	330	442	58
5	24	3		341	395	532	368	426	569	402	465	617	54
6	30	3		361	418	571	388	449	608	422	488	656	50
7	34	3		379	440	608	406	471	646	440	510	693	87
8	40	3		399	463	647	426	494	685	459	533	732	82
9	44	4		494	574	793	530	616	843	575	668	906	79
10	50	4		514	598	832	550	639	882	595	691	945	74
11	54	4		532	619	870	568	661	920	613	713	983	107
12	60	4		551	643	909	587	684	959	633	736	1022	102
13	64	4		569	664	946	605	706	996	651	758	1059	99
14	68	5		665	775	1092	710	827	1155	767	892	1234	136
15	74	5		685	799	1131	730	850	1194	786	915	1273	131
16	78	5		703	820	1169	748	872	1231	804	937	1310	128
17	84	5		722	844	1208	767	895	1270	824	960	1349	123
18	88	5		740	865	1245	785	917	1308	842	982	1387	148
reduction per wall socket				34	32	43	43	42	55	54	55	71	

double rod

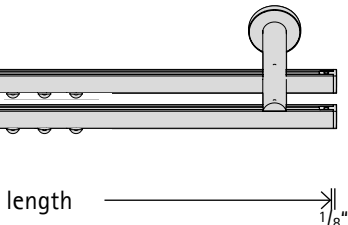

set-no. **Mono** 02185

length (ft.)	rollers	brackets		bracket 3"			bracket 5"		
				A	B	C	A	B	C
3	32	2	\$	343	395	538	365	421	570
4	40	2		379	438	613	401	464	644
5	48	3		514	596	827	547	634	874
6	60	3		553	642	905	587	681	952
7	68	3		589	686	979	623	724	1026
8	80	3		628	732	1057	662	771	1104
9	88	4		763	890	1271	808	941	1334
10	100	4		802	936	1349	847	988	1412
11	108	4		838	980	1424	883	1031	1486
12	120	4		878	1026	1502	922	1078	1564
13	128	4		914	1070	1576	958	1121	1639
14	136	5		1049	1227	1790	1105	1292	1868
15	148	5		1088	1274	1868	1144	1338	1946
16	156	5		1124	1317	1943	1180	1382	2021
17	168	5		1163	1364	2021	1219	1428	2099
18	176	5		1199	1407	2096	1255	1472	2174
reduction per wall socket				12	0	6	23	12	22

Notes

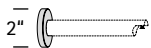

larger base plate + \$ 7.00 per bracket

- rods in excess of 9ft. will be delivered in two sections

traversing round 3/4" dia.

finishes available

material: aluminium

A 79/78 aluminium/polished aluminium

79/56 aluminium/black

B 77/78 stainless steel/polished aluminium

77/56 stainless steel/black

single rod

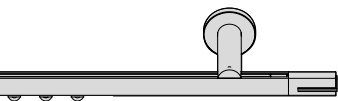

length $\rightarrow 1\frac{5}{8}"$

Duo set-no. 02184

length (ft.)	rollers	brackets		bracket 3"		bracket 5"		bracket 7"		ripplefold surcharge
				A	B	A	B	A	B	
3	16	2	\$	351	404	369	424	392	450	61
4	20	2		369	425	387	446	410	472	58
5	24	3		465	537	492	567	526	606	54
6	30	3		485	560	512	591	545	630	50
7	34	3		503	582	530	612	563	651	87
8	40	3		522	605	549	636	583	675	82
9	44	4		618	716	654	757	699	809	79
• 10	50	4		637	739	673	780	719	832	74
11	54	4		655	761	691	802	737	854	107
12	60	4		675	784	711	825	756	877	102
13	64	4		693	806	729	847	774	899	99
set-no. 14	68	5		789	917	834	969	890	1034	136
15	74	5		808	940	853	992	910	1057	131
16	78	5		826	962	871	1014	928	1079	128
17	84	5		846	985	891	1037	947	1102	123
18	88	5		864	1007	909	1059	965	1124	148
reduction per wall socket				96	103	105	113	116	126	

double rod

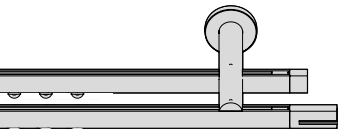

length $\rightarrow 1\frac{5}{8}"$

Duo set-no. 02189

length (ft.)	rollers	brackets		bracket 3"		bracket 5"	
				A	B	A	B
3	32	2	\$	522	603	545	629
4	40	2		558	646	581	672
5	48	3		694	804	727	842
6	60	3		733	850	766	889
7	68	3		769	894	802	932
8	80	3		808	940	842	979
9	88	4		943	1098	988	1149
• 10	100	4		982	1144	1027	1196
11	108	4		1018	1188	1063	1239
12	120	4		1057	1234	1102	1286
13	128	4		1093	1278	1138	1329
set-no. 14	136	5		1229	1435	1285	1500
15	148	5		1268	1482	1324	1546
16	156	5		1304	1525	1360	1590
17	168	5		1343	1572	1399	1636
18	176	5		1379	1615	1435	1680
reduction per wall socket				101	104	113	116



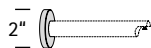

Notes



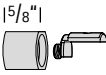
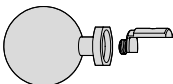
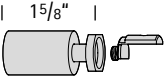
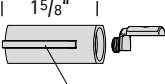

larger base plate + \$ 7.00 per bracket

• rods in excess of 9ft. will be delivered in two sections

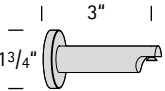
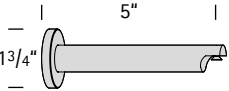
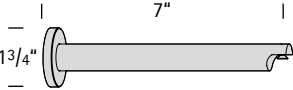

traversing round 3/4" dia.

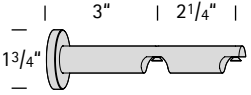
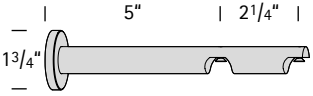
components	part	part-no.	color-no.	price	
	 3/4"	traversing rod 3/4" dia. material: aluminium	30570 50 white	Cut to measure \$ / lin ft.	14.80
			56 black		14.80
			70 chromium		34.20
			77 stainless steel		18.50
			79 aluminium		14.80
	finial Metro also end cap for double rod	21801 50 white		33.80	
		56 black		33.80	
		70 chromium		56.30	
		77 stainless steel		38.90	
		79 aluminium		33.80	
	finial Cosmo	21802 50 white		69.80	
		56 black		69.80	
		70 chromium		97.80	
		77 stainless steel		80.40	
		79 aluminium		69.80	
	finial Retro	21803 50 white		69.80	
		56 black		69.80	
		70 chromium		97.80	
		77 stainless steel		80.40	
		79 aluminium		69.80	
	finial Duo	21804 77/56 stainless steel/black		76.50	
		77/78 stainless steel/pol. aluminium		76.50	
		79/56 aluminium/black		67.50	
		79/78 aluminium/polished aluminium		67.50	
		color-no. 2			
	end cap Mono plastic	21829 50 white		5.70	
		56 black		5.70	
		70 chromium		5.70	
		77 stainless steel		5.70	
		79 aluminium		5.70	
	bracket 3"	21811 50 white		77.70	
		56 black		77.70	
		70 chromium		108.80	
		77 stainless steel		89.40	
		79 aluminium		77.70	
	bracket 5"	21812 50 white		86.70	
		56 black		86.70	
		70 chromium		121.30	
		77 stainless steel		99.70	
		79 aluminium		86.70	
	bracket 7"	21813 50 white		98.00	
		56 black		98.00	
		70 chromium		137.10	
		77 stainless steel		112.70	
		79 aluminium		98.00	

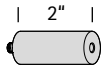
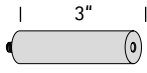
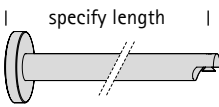
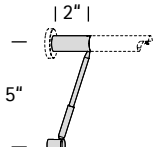

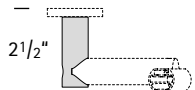
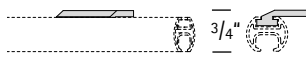
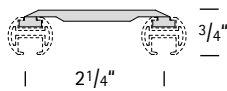
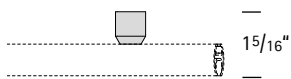
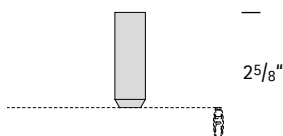

traversing round 3/4" dia.

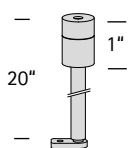
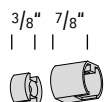
components	part	part-no.	color-no.	price
	double bracket 3"	21821	50 white	99.10
			56 black	99.10
			70 chromium	138.70
			77 stainless steel	114.10
			79 aluminium	99.10
	double bracket 5"	21822	50 white	110.30
			56 black	110.30
			70 chromium	154.40
			77 stainless steel	127.00
			79 aluminium	110.30
	larger base plate e.g. 21813X	X		surcharge 7.00
	extension piece 3/4" for brackets and ceiling converter	21618	50 white	24.80
			56 black	24.80
			70 chromium	34.70
			77 stainless steel	28.60
			79 aluminium	24.80
	extension piece 2" for brackets and ceiling converter	21619	50 white	30.40
			56 black	30.40
			70 chromium	42.50
			77 stainless steel	35.80
			79 aluminium	30.40
	extension piece 3" for brackets and ceiling converter	21819	50 white	38.30
			56 black	38.30
			70 chromium	53.60
			77 stainless steel	44.10
			79 aluminium	38.30
	shorten bracket service e.g. 21812-77-S-4"	S		surcharge 43.00
	bracket support incl. 2" bracket extension	21817	50 white	162.10
			56 black	162.10
			70 chromium	222.90
			77 stainless steel	186.40
			79 aluminium	162.10



traversing round 3/4" dia.

components	part	part-no.	color-no.	price
	ceiling converter for ceiling mounts for single and double rod	21818	50 white	58.50
			56 black	58.50
			70 chromium	82.00
			77 stainless steel	67.30
			79 aluminium	58.50
	ceiling bracket close to ceiling shadow gap 1/8"	30514	50 white	20.00
			79 aluminium	20.00
	ceiling bracket close to ceiling for double rod shadow gap 1/8"	30524	50 white	33.30
			79 aluminium	33.30
	ceiling bracket 3/4"	21614	50 white	50.70
			56 black	50.70
			70 chromium	69.80
			77 stainless steel	57.40
			79 aluminium	50.70
	ceiling bracket 2"	21616	50 white	60.50
			56 black	60.50
			70 chromium	83.30
			77 stainless steel	69.80
			79 aluminium	60.50
	extension piece 3/4" for ceiling bracket 21614, 21616	21617	50 white	24.80
			56 black	24.80
			70 chromium	36.00
			77 stainless steel	28.60
			79 aluminium	24.80
	ceiling bracket 20" can be shortened	21615	50 white	93.40
			56 black	93.40
			70 chromium	119.40
			77 stainless steel	107.40
			79 aluminium	93.40
	wall socket can be used at both ends	21705	50 white	49.50
			56 black	49.50
			70 chromium	72.00
			77 stainless steel	63.00
			79 aluminium	49.50

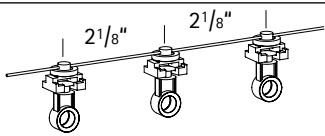
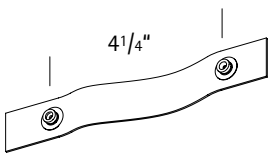
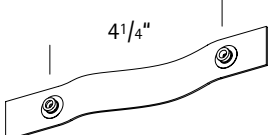
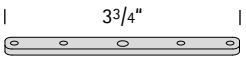
traversing round 3/4" dia.

components	part	part-no.	color-no.	price
 1/2"	roller with eyelet	30082	50 white	0.80
 5/8"	curtain hook	30080	50 white	0.20
	runner for batons can be retrofitted	30078	50 white	3.60
	stop clamp	30089	50 white	1.80
 2 1/8" 2 1/8"	carriers with cord spacing between carriers 2 1/8" with easy snap for convenient installation	40 pcs 29085/40 60 pcs 29085/60 80 pcs 29085/80 100 pcs 29085/100 120 pcs 29085/120	50 white 50 white 50 white 50 white 50 white	52.00 78.00 104.00 130.00 156.00
 4 1/4"	ripplefold tape spacing between buttons 4 1/4" 100 % fullness spool 100 yards	29012	50 white 11 transparent	413.60 413.60
 4 1/4"	ripplefold tape spacing between buttons 4 1/4" 100 % fullness cut to measure	29010	50 white 11 transparent	per lin. ft. 1.70 per lin. ft. 1.70
 3 3/4"	connector for brackets 21811 - 21822	30578	99	16.90

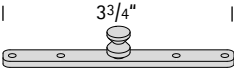
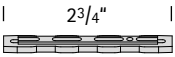
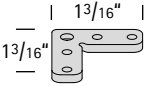
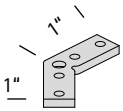
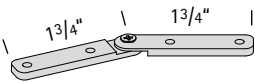
traversing round 3/4" dia.

components	part	part-no.	color-no.	price
	connector for ceiling brackets 21614, 21616	30577	99	16.90
	connector for brackets 30514, 30524 (plastic)	21719	99	13.50
	corner connector 90° mitre cut \$ 43.00	30550	99	25.90
	corner connector 135° mitre cut \$ 43.00	30551	99	30.40
	corner connector flexible mitre cut \$ 43.00	30552	99	59.70
	batons			see page 275
	accessories			see page 276



quintett brushed brass



xenon antique bronzed



duett brushed nickel



finishes available

60 polished brass

62 brushed brass

72 brushed nickel

duett 62 brushed brass



menuett 72 brushed nickel



quintett 60 polished brass



scale 1:1

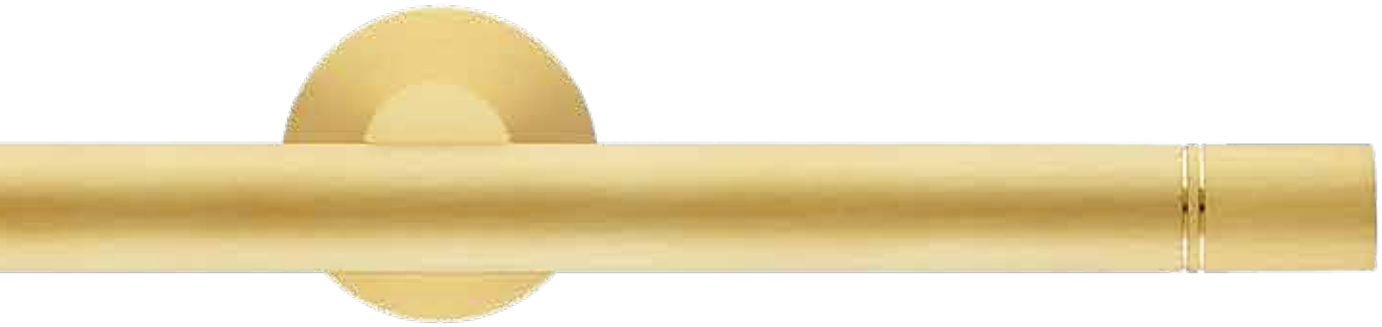

brass-traversing round 3/4" dia.

finishes available

material: brass

A 60 polished brass

B 62 brushed brass

C 72 brushed nickel

single rod

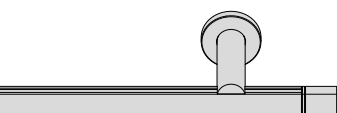

length → 1" |

set-no. Duett 02160

length (ft.)	rollers	brackets	\$	bracket 3"			bracket 5"			bracket 7"			ripplefold surcharge
				A	B	C	A	B	C	A	B	C	
3	16	2		419	466	487	446	498	521	476	535	560	61
4	20	2		463	506	528	490	539	562	520	576	601	58
5	24	3		599	659	688	640	707	739	686	763	797	54
6	30	3		645	701	730	686	749	781	732	805	839	50
7	34	3		689	741	770	730	790	821	776	845	880	87
8	40	3		735	783	812	776	832	863	822	888	922	82
9	44	4		872	936	972	926	1001	1040	987	1075	1118	79
10	50	4		917	978	1014	971	1043	1082	1033	1117	1160	74
11	54	4		962	1019	1055	1016	1083	1123	1077	1157	1201	107
12	60	4		1007	1061	1097	1061	1125	1165	1123	1199	1243	102
13	64	4		1052	1101	1138	1106	1166	1206	1167	1240	1283	99
14	68	5		1188	1254	1297	1256	1335	1382	1332	1427	1479	136
15	74	5		1234	1296	1340	1301	1377	1425	1378	1469	1522	131
16	78	5		1278	1336	1380	1346	1417	1465	1422	1510	1562	128
17	84	5		1324	1378	1422	1391	1459	1507	1468	1552	1604	123
18	88	5		1368	1419	1463	1436	1500	1548	1512	1592	1645	148
reduction per wall socket				77	119	130	90	135	147	105	154	166	

double rod

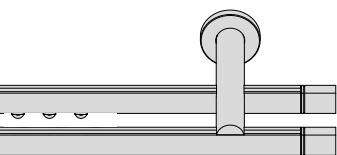

length → 1" |

set-no. Duett 02163

length (ft.)	rollers	brackets	\$	bracket 3"			bracket 5"			
				A	B	C	A	B	C	
3	32	2		702	766	798	729	799	833	
4	40	2		790	847	879	817	880	914	
5	48	3		995	1070	1111	1036	1119	1163	
6	60	3		1087	1154	1195	1128	1204	1247	
7	68	3		1175	1235	1276	1216	1285	1328	
8	80	3		1267	1319	1360	1308	1369	1412	
9	88	4		1472	1542	1591	1527	1608	1661	
10	100	4		1564	1626	1676	1618	1692	1745	
11	108	4		1652	1707	1757	1707	1773	1826	
12	120	4		1744	1791	1841	1798	1857	1910	
13	128	4		1832	1872	1922	1887	1938	1991	
14	136	5		2037	2095	2153	2106	2177	2240	
15	148	5		2129	2179	2238	2197	2261	2325	
16	156	5		2217	2260	2319	2286	2342	2406	
17	168	5		2309	2344	2403	2377	2427	2490	
18	176	5		2397	2425	2484	2466	2508	2571	
reduction per wall socket				85	156	172	99	172	189	

Notes

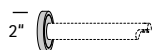

larger base plate + \$ 7.00 per bracket

• rods in excess of 9ft. will be delivered in two sections

brass-traversing round 3/4" dia.

finishes available

material: brass

- A 60 polished brass
- B 62 brushed brass
- C 72 brushed nickel

single rod

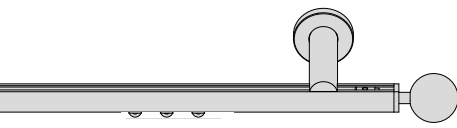

length →

set-no.

- Menuett** 02161
- Quintett** 02162

length (ft.)	rollers	brackets		bracket 3"			bracket 5"			bracket 7"			ripplefold surcharge
				A	B	C	A	B	C	A	B	C	
3	16	2	\$	488	550	577	515	582	611	546	619	649	61
4	20	2		533	590	617	560	622	651	590	659	690	58
5	24	3		669	743	777	710	791	828	756	847	886	54
6	30	3		715	785	819	755	833	870	801	889	928	50
7	34	3		759	825	860	800	874	911	846	929	969	87
8	40	3		805	867	902	845	916	953	891	971	1011	82
9	44	4		941	1020	1062	995	1085	1130	1057	1159	1207	79
• 10	50	4		987	1062	1104	1041	1127	1172	1102	1201	1249	74
11	54	4		1031	1102	1144	1085	1167	1212	1147	1241	1290	107
12	60	4		1077	1144	1186	1131	1209	1254	1192	1283	1332	102
13	64	4		1121	1185	1227	1175	1250	1295	1237	1324	1372	99
14	68	5		1258	1337	1387	1325	1418	1472	1402	1511	1569	136
15	74	5		1304	1380	1429	1371	1461	1514	1448	1553	1611	131
16	78	5		1348	1420	1469	1415	1501	1554	1492	1594	1651	128
17	84	5		1394	1462	1511	1461	1543	1596	1538	1636	1693	123
18	88	5		1438	1503	1552	1505	1584	1637	1582	1676	1734	148
reduction per wall socket				112	161	175	125	177	192	140	196	211	

double rod

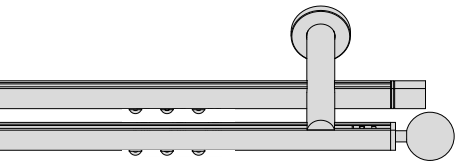

length →

set-no.

- Menuett** 02164
- Quintett** 02165

length (ft.)	rollers	brackets		bracket 3"			bracket 5"		
				A	B	C	A	B	C
3	32	2	\$	771	850	887	799	883	922
4	40	2		860	931	968	887	964	1003
5	48	3		1065	1154	1200	1106	1203	1252
6	60	3		1157	1238	1284	1198	1287	1336
7	68	3		1245	1319	1365	1286	1368	1417
8	80	3		1337	1403	1449	1378	1453	1501
9	88	4		1542	1626	1681	1597	1692	1750
• 10	100	4		1633	1710	1765	1688	1776	1834
11	108	4		1722	1791	1846	1777	1857	1915
12	120	4		1813	1875	1930	1868	1941	2000
13	128	4		1902	1956	2011	1957	2022	2081
14	136	5		2107	2179	2243	2176	2261	2330
15	148	5		2199	2263	2327	2267	2345	2414
16	156	5		2287	2344	2408	2356	2426	2495
17	168	5		2379	2428	2492	2447	2510	2579
18	176	5		2467	2509	2573	2536	2591	2660
reduction per wall socket				120	198	216	134	214	234

Notes

larger base plate + \$ 7.00 per bracket

• rods in excess of 9ft. will be delivered in two sections

finishes available

60 polished brass

62 brushed brass

72 brushed nickel

80 antique bronzed

argon 60 polished brass



radon 80 antique bronzed



xenon 72 brushed nickel



scale 1:1



aluminium/brass traversing round 3/4" dia.

finishes available

- A 60 polished brass
- B 62 brushed brass
- C 72 brushed nickel
- 80 antique bronzed

material

brackets, finials: brass
traversing rod: aluminium, optional brass

single rod



length \rightarrow | $\frac{7}{8}$ "

Xenon
rod aluminium 02142
rod brass 02112

length (ft.)	rollers	brackets	\$	bracket 3"			bracket 5"			bracket 7"			ripplefold surcharge
				A	B	C	A	B	C	A	B	C	
3	16	2		333	376	396	360	408	430	390	445	469	61
4	20	2		354	394	414	381	426	448	412	463	487	58
5	24	3		468	524	552	509	573	603	555	628	661	54
6	30	3		492	544	571	532	592	622	578	648	681	50
7	34	3		513	562	589	554	610	640	600	666	699	87
8	40	3		537	581	609	577	630	660	623	685	718	82
9	44	4		651	711	746	705	776	814	766	850	892	79
10	50	4		674	731	766	728	796	834	789	870	912	74
11	54	4		696	749	784	750	814	852	811	888	930	107
12	60	4		719	768	804	773	833	872	834	907	949	102
13	64	4		741	786	822	795	851	890	856	925	967	99
14	68	5		855	916	959	922	997	1044	999	1090	1141	136
15	74	5		878	936	979	945	1017	1064	1022	1110	1161	131
16	78	5		900	954	997	967	1035	1082	1044	1128	1179	128
17	84	5		923	974	1016	990	1055	1101	1067	1147	1198	123
18	88	5		945	992	1034	1012	1073	1119	1089	1165	1216	148
reduction per wall socket				67	108	118	81	124	135	96	143	155	

traversing rod brass
surcharge 22.50 \$/lin ft. **!**

double rod

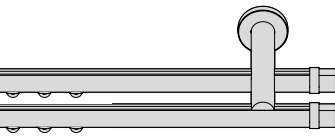

length \rightarrow | $\frac{7}{8}$ "

Xenon
rod aluminium 02145
rod brass 02115

length (ft.)	rollers	brackets	\$	bracket 3"			bracket 5"			
				A	B	C	A	B	C	
3	32	2		529	587	616	557	620	651	
4	40	2		573	623	652	600	656	687	
5	48	3		733	801	839	774	850	891	
6	60	3		780	840	878	821	889	930	
7	68	3		823	876	914	864	925	966	
8	80	3		870	915	953	911	964	1005	
9	88	4		1030	1092	1140	1085	1158	1209	
10	100	4		1076	1132	1179	1131	1198	1248	
11	108	4		1120	1168	1215	1175	1234	1284	
12	120	4		1166	1207	1254	1221	1273	1324	
13	128	4		1210	1243	1290	1265	1309	1360	
14	136	5		1370	1420	1477	1439	1503	1564	
15	148	5		1417	1460	1516	1485	1542	1603	
16	156	5		1460	1496	1552	1529	1578	1639	
17	168	5		1507	1535	1591	1575	1617	1678	
18	176	5		1550	1571	1627	1619	1653	1714	
reduction per wall socket				67	134	148	81	150	166	

traversing rod brass
surcharge 22.50 \$/lin ft. **!**

Notes

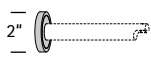

larger base plate + \$ 7.00 per bracket

• rods in excess of 9ft. will be delivered in two sections

aluminium/brass traversing round 3/4" dia.

finishes available

- A 60 polished brass
- B 62 brushed brass
- C 72 brushed nickel
- 80 antique bronzed

material

- brackets, finials: brass
- traversing rod: aluminium, optional brass

single rod

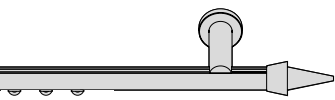

length →

- set-no. • 10 Argon rod aluminum 02140
- 11 Argon rod brass 02110
- 12 Argon rod aluminum 02141
- 13 Argon rod brass 02110
- 14 Radon rod aluminum 02141
- 15 Radon rod brass 02111
- 16 Radon rod aluminum 02141
- 17 Radon rod brass 02111
- 18 Radon rod aluminum 02141
- 19 Radon rod brass 02111

length (ft.)	rollers	brackets		bracket 3"			bracket 5"			bracket 7"			ripplefold surcharge
				A	B	C	A	B	C	A	B	C	
3	16	2	\$	360	409	431	387	441	465	417	478	504	61
4	20	2		381	427	449	408	459	483	439	496	522	58
5	24	3		495	557	587	536	605	638	582	661	696	54
6	30	3		519	576	606	559	625	657	605	680	715	50
7	34	3		540	594	624	581	643	675	627	698	733	87
8	40	3		564	614	644	604	662	695	650	718	753	82
9	44	4		678	744	781	732	809	849	793	883	927	79
10	50	4		701	763	801	755	828	869	816	902	946	74
11	54	4		723	781	819	777	846	887	838	920	964	107
12	60	4		746	801	838	800	866	906	861	940	984	102
13	64	4		768	819	856	822	884	924	883	958	1002	99
14	68	5		882	949	994	949	1030	1079	1026	1123	1176	136
15	74	5		905	969	1013	972	1050	1098	1049	1142	1195	131
16	78	5		927	987	1031	994	1068	1116	1071	1160	1213	128
17	84	5		950	1006	1051	1017	1087	1136	1094	1180	1233	123
18	88	5		972	1024	1069	1039	1105	1154	1116	1198	1251	148
reduction per wall socket				81	124	136	94	141	153	110	159	172	

traversing rod brass
surcharge 22.50 \$/lin ft. !

double rod

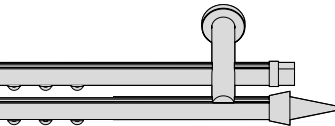

length →

- set-no. • 11 Argon rod aluminum 02143
- 12 Argon rod brass 02113
- 13 Argon rod aluminum 02143
- 14 Argon rod brass 02113
- 15 Radon rod aluminum 02144
- 16 Radon rod brass 02114
- 17 Radon rod aluminum 02144
- 18 Radon rod brass 02114

length (ft.)	rollers	brackets		bracket 3"			bracket 5"			
				A	B	C	A	B	C	
3	32	2	\$	556	620	651	584	653	686	
4	40	2		600	656	687	627	689	722	
5	48	3		760	833	874	801	883	926	
6	60	3		807	872	913	848	922	965	
7	68	3		850	908	949	891	958	1001	
8	80	3		897	948	988	938	997	1040	
9	88	4		1057	1125	1174	1112	1191	1244	
10	100	4		1103	1164	1214	1158	1230	1283	
11	108	4		1147	1200	1250	1202	1266	1319	
12	120	4		1193	1239	1289	1248	1305	1358	
13	128	4		1237	1275	1325	1292	1341	1394	
14	136	5		1397	1453	1511	1466	1535	1598	
15	148	5		1444	1492	1551	1512	1575	1638	
16	156	5		1487	1528	1587	1556	1611	1674	
17	168	5		1534	1567	1626	1602	1650	1713	
18	176	5		1577	1603	1662	1646	1686	1749	
reduction per wall socket				80	150	166	94	167	183	

traversing rod brass
surcharge 22.50 \$/lin ft. !

Notes

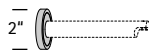

larger base plate + \$ 7.00 per bracket

• rods in excess of 9ft. will be delivered in two sections

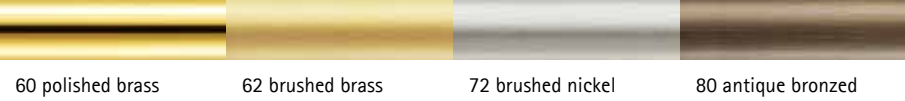

finishes available

set for alternative finials



scale 1:1

finials



fox



atlas



swing



akzent



jazz



areal



indigo



cosima



imola



aida



iris



julia

aluminium/brass traversing round 3/4" dia.

finishes available

- A 60 polished brass
- B 62 brushed brass
- C 72 brushed nickel
- 80 antique bronzed

material

brackets, finials: brass
traversing rod: aluminium, optional brass

single rod without finials



length →

set-no.

rod aluminum 02148
rod brass 02118

traversing rod brass surcharge 22.50 \$/lin ft.

set without finials

finials see page 157

length (ft.)	rollers	brackets	\$	bracket 3"			bracket 5"			bracket 7"			ripplefold surcharge
				A	B	C	A	B	C	A	B	C	
3	16	2		286	314	329	313	347	363	344	384	402	61
4	20	2		308	332	347	335	365	381	365	402	420	58
5	24	3		422	462	484	462	511	535	508	566	594	54
6	30	3		445	482	504	485	530	555	531	586	613	50
7	34	3		467	500	522	507	548	573	553	604	631	87
8	40	3		490	519	542	530	568	593	576	624	651	82
9	44	4		604	649	679	658	714	747	719	788	825	79
10	50	4		627	669	699	681	734	767	742	808	844	74
11	54	4		649	687	717	703	752	785	764	826	862	107
12	60	4		672	707	736	726	771	804	787	845	882	102
13	64	4		694	725	754	748	789	822	809	863	900	99
14	68	5		808	855	892	875	936	977	952	1028	1074	136
15	74	5		831	874	911	899	955	996	975	1048	1093	131
16	78	5		853	892	929	920	973	1014	997	1066	1111	128
17	84	5		876	912	949	944	993	1034	1020	1085	1131	123
18	88	5		898	930	967	965	1011	1052	1042	1103	1149	148
reduction per wall socket				44	77	85	58	93	102	73	112	121	

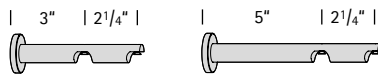

double rod without finials

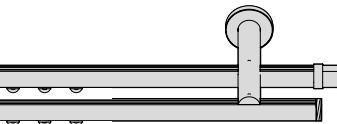

length →

set-no.

rod aluminum 02149
rod brass 02119

traversing rod brass surcharge 22.50 \$/lin ft.

set without finials

finials see page 157

length (ft.)	rollers	brackets	\$	bracket 3"			bracket 5"			
				A	B	C	A	B	C	
3	32	2		483	525	549	510	558	584	
4	40	2		526	561	585	554	594	620	
5	48	3		686	739	771	728	788	824	
6	60	3		733	778	811	774	827	863	
7	68	3		776	814	847	818	863	899	
8	80	3		823	853	886	864	903	938	
9	88	4		983	1031	1072	1038	1097	1142	
10	100	4		1030	1070	1111	1085	1136	1181	
11	108	4		1073	1106	1147	1128	1172	1217	
12	120	4		1120	1145	1187	1175	1211	1256	
13	128	4		1163	1181	1223	1218	1247	1292	
14	136	5		1323	1359	1409	1392	1441	1496	
15	148	5		1370	1398	1448	1439	1480	1535	
16	156	5		1413	1434	1484	1482	1516	1571	
17	168	5		1460	1473	1524	1529	1555	1611	
18	176	5		1503	1509	1560	1572	1591	1647	
reduction per wall socket				44	103	115	57	119	132	



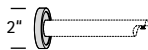







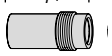

Notes





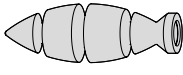





larger base plate + \$ 7.00 per bracket

- rods in excess of 9ft. will be delivered in two sections



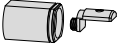
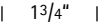
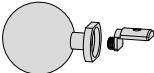
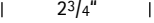
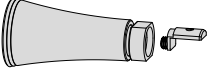
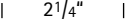
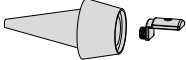

aluminium/brass traversing round 3/4" dia.

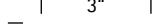
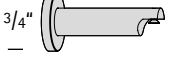
finials	part	part-no.	color-no.	price
 1 3/4"	finial Atlas	20704		
 1"	Areal	20804	60 polished brass 62 brushed brass 71 polished nickel 72 brushed nickel 80 antique bronzed	67.50 81.00 81.00 86.00 86.00
 2 1/4"	Akzent	20604		
 1 3/4"	finial Fox	22601		
 1 5/8"	Swing	22602	60 polished brass 62 brushed brass 71 polished nickel 72 brushed nickel 80 antique bronzed	52.90 63.40 63.40 67.30 67.30
 2"	Jazz	22603		
 2 1/4"	finial Indigo	20601		
 2 1/4"	Imola	20602	60 polished brass 62 brushed brass 72 brushed nickel 80 antique bronzed	56.30 67.50 71.60 71.60
 2 1/8"	Iris	20702		
 5"	finial Cosima	22901		
 2 1/2"	Julia	22902	62 brushed brass 72 brushed nickel 80 antique bronzed 88 gold leaf patina (for brushed nickel)	184.60 221.80 221.80 221.80
 5"	Aida	right 22903 left 22904		
	adapter for brass finials (for sets 02148, 02149, 02118, 02119)	21699	99	14.70

aluminium/brass traversing rod 3/4" dia.

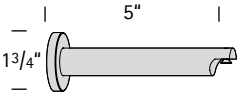
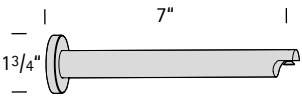
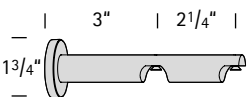
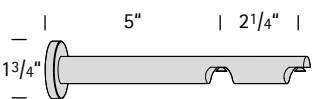
components	part	part-no.	color-no.	price	
 	traversing rod 3/4" dia. material: aluminium	30570	60 polished brass	Cut to measure \$/ lin. ft.	18.50
			62 brushed brass		14.80
			72 brushed nickel		14.80
			80 antique bronzed		14.80
 	traversing rod 3/4" dia. material: brass	30670	60 polished brass	Cut to measure \$/ lin. ft.	41.00
			62 brushed brass		37.30
			72 brushed nickel		37.30
			80 antique bronzed		37.30
 	finial Duett also end cap for double rod only with rod 30670	21671	60 polished brass	47.30	
			62 brushed brass	56.70	
			72 brushed nickel	60.10	
 	finial Menuett only with rod 30670	21672	60 polished brass	82.20	
			62 brushed brass	98.60	
			72 brushed nickel	104.70	
 	finial Quintett only with rod 30670	21673	60 polished brass	82.20	
			62 brushed brass	98.60	
			72 brushed nickel	104.70	
 	finial Argon	21601	60 polished brass	51.50	
			62 brushed brass	61.90	
			72 brushed nickel	65.80	
			80 antique bronzed	65.80	
 	finial Radon	21602	60 polished brass	51.50	
			62 brushed brass	61.90	
			72 brushed nickel	65.80	
			80 antique bronzed	65.80	
 	end cap Xenon also end cap for double rod	21629	60 polished brass	38.00	
			62 brushed brass	45.60	
			72 brushed nickel	48.40	
			80 antique bronzed	48.40	
 	bracket 3"	21611	60 polished brass	92.30	
			62 brushed brass	112.00	
			72 brushed nickel	119.40	
			80 antique bronzed	119.40	

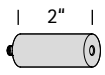
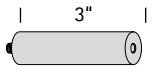

aluminium/brass traversing round $\frac{3}{4}$ " dia.

components	part	part-no.	color-no.	price	
	bracket 5"	21612	60	polished brass	105.80
			62	brushed brass	128.20
			72	brushed nickel	136.40
			80	antique bronzed	136.40
	bracket 7"	21613	60	polished brass	121.10
			62	brushed brass	146.70
			72	brushed nickel	155.80
			80	antique bronzed	155.80
	double bracket 3"	21621	60	polished brass	116.80
			62	brushed brass	141.50
			72	brushed nickel	150.50
			80	antique bronzed	150.50
	double bracket 5"	21622	60	polished brass	130.50
			62	brushed brass	158.00
			72	brushed nickel	167.90
			80	antique bronzed	167.90
	larger base plate e.g. 21612X	X			surcharge 7.00
	extension piece $\frac{3}{16}$ " for brackets and ceiling converter	12718	60	polished brass	17.80
			62	brushed brass	21.40
			72	brushed nickel	22.50
	extension piece $\frac{3}{4}$ " for brackets and ceiling converter	12618	60	polished brass	25.90
			62	brushed brass	31.10
			72	brushed nickel	33.10
			80	antique bronzed	33.10
	extension piece 2" for brackets and ceiling converter	12619	60	polished brass	32.50
			62	brushed brass	38.90
			72	brushed nickel	41.10
			80	antique bronzed	41.10
	extension piece 3" for brackets and ceiling converter	12819	60	polished brass	39.20
			62	brushed brass	47.00
			72	brushed nickel	49.90
			80	antique bronzed	49.90



aluminium/brass traversing round 3/4" dia.

components	part	part-no.	color-no.	price
 <p>specify length</p>	shorten bracket service e.g. 21612-62-S-4"	S		surcharge 43.00
 <p>2" 5"</p>	bracket support incl. 2" bracket extension	12617	60 62 72 80	polished brass 153.10 brushed brass 183.60 brushed nickel 194.70 antique bronzed 194.70
 <p>2 1/2"</p>	ceiling converter for ceiling mounts for single and double rod	16618	60 62 72 80	polished brass 58.50 brushed brass 70.30 brushed nickel 74.50 antique bronzed 74.50
 <p>3/8" 7/8" </p>	wall socket can be used at both ends	21705	60 62 72 80	polished brass 63.00 brushed brass 49.50 brushed nickel 49.50 antique bronzed 49.50
 <p>3/4"</p>	ceiling bracket close to ceiling shadow gap 1/8"	30514	50 79	white aluminium 20.00 aluminium 20.00
 <p>3/4" 2 1/4"</p>	ceiling bracket close to ceiling for double rod shadow gap 1/8"	30524	50 79	white aluminium 33.30 aluminium 33.30
 <p>15/16"</p>	ceiling bracket 3/4"	21614	60 62 72 80	polished brass 57.40 brushed brass 57.40 brushed nickel 57.40 antique bronzed 57.40
 <p>2 5/8"</p>	ceiling bracket 2"	21616	60 62 72 80	polished brass 69.80 brushed brass 69.80 brushed nickel 69.80 antique bronzed 69.80

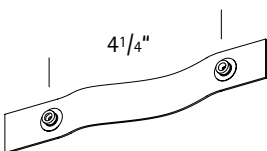
aluminium/brass traversing round 3/4" dia.

components	part	part-no.	color-no.	price		
	extension piece 3/4" for ceiling bracket 21614, 21616	21617	60	polished brass	28.60	
			62	brushed brass	28.60	
			72	brushed nickel	28.60	
			80	antique bronzed	28.60	
	ceiling bracket 20" can be shortened	21615	60	polished brass	107.40	
			62	brushed brass	107.40	
			72	brushed nickel	107.40	
			80	antique bronzed	107.40	
	roller with eyelet	30082	50	white	0.80	
	curtain hook	30080	50	white	0.20	
	runner for batons can be retrofitted	30078	50	white	3.60	
	stop clamp	30089	50	white	1.80	
	carriers with cord spacing between carriers 2 1/8" with easy snap for convenient installation	40 pcs	29085/40	50	white	52.00
		60 pcs	29085/60	50	white	78.00
		80 pcs	29085/80	50	white	104.00
		100 pcs	29085/100	50	white	130.00
		120 pcs	29085/120	50	white	156.00
	ripplefold tape spacing between buttons 4 1/4" 100 % fullness spool 100 yards	29012	50	white	413.60	
			11	transparent	413.60	

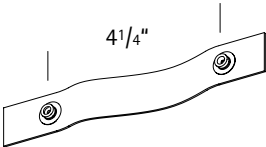
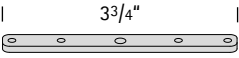
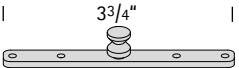
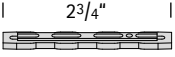
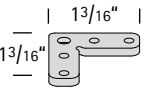
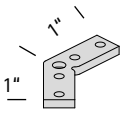
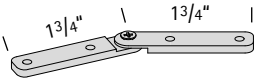
aluminium/brass traversing round 3/4" dia.

components	part	part-no.	color-no.	price
	ripplefold tape spacing between buttons 4 1/4" 100 % fullness cut to measure	29010	50 11 white transparent	per lin. ft. 1.70 per lin. ft. 1.70
	connector for brackets 21611 - 21622	30578	99	16.90
	connector for ceiling brackets 21614, 21616	30577	99	16.90
	connector for brackets 30514, 30524 (plastic)	21719	99	13.50
	corner connector 90° mitre cut \$ 43.00	30550	99	25.90
	corner connector 135° mitre cut \$ 43.00	30551	99	30.40
	corner connector flexible mitre cut \$ 43.00	30552	99	59.70
	batons		see page 275	
	accessories		see page 276	

page 164



page 168



page 172





traversing round 3/4" dia.



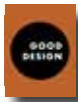

zenit 20
with finial Metro

77 stainless steel

scale 1:1

traversing round 3/4" dia.



traversing round 3/4" dia.

finishes available

- A 79 aluminium
- B 77 stainless steel
- C 70 chromium

material: aluminium

single rod

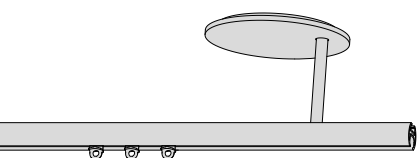

length →

set-no.

Zenit 20 02290

set without
finials
finials see below

length rollers brackets

bracket 3"

bracket 5"

ripplefold

(ft.)				A	B	C	A	B	C	surcharge
3	16	2	\$	363	419	523	430	497	611	61
4	20	3		532	614	763	633	731	895	58
5	24	3		550	636	800	651	752	932	54
6	30	3		569	659	839	670	776	971	50
7	34	3		587	681	877	688	797	1009	87
8	40	4		758	878	1118	892	1033	1294	82
9	44	4		776	900	1155	910	1055	1331	79
10	50	4		795	923	1194	930	1078	1370	74
11	54	4		813	945	1232	948	1100	1407	107
12	60	5		984	1142	1473	1152	1335	1693	102
13	64	5		1002	1163	1510	1170	1357	1730	99
14	68	5		1020	1185	1548	1188	1379	1767	136
15	74	5		1039	1208	1587	1208	1402	1806	131
16	78	6		1208	1404	1826	1410	1636	2090	128
17	84	6		1228	1427	1865	1430	1659	2129	123
18	88	6		1246	1449	1903	1448	1681	2166	148
reduction per wall socket				101	111	130	135	149	174	

• rods in excess of 9ft. will be delivered in two sections

components

part

set-no.

color-no.

price

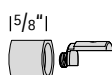

finial
Metro

21801

70 chromium
77 stainless steel
79 aluminium

56.30
38.90
33.80

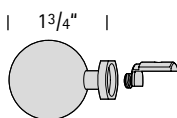

finial
Cosmo

21802

70 chromium
77 stainless steel
79 aluminium

97.80
80.40
69.80

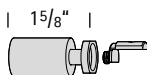

finial
Retro

21803

70 chromium
77 stainless steel
79 aluminium

97.80
80.40
69.80

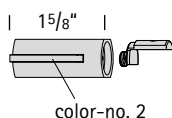

finial
Duo

21804

77/56 stainless steel/black
77/78 stainless steel/pol. aluminium
79/56 aluminium/black
79/78 aluminium/polished aluminium

76.50
76.50
67.50
67.50

rods, brackets, components

see page 174

traversing round 3/4" dia.

votum 20 stainless steel



50 white
(Novum only)

70 chromium

77 stainless steel

79 aluminium



quantum 20 77 stainless steel

quantum 20 79 aluminium

votum 20 70 chromium



novum 20 77 stainless steel

scale 1:1



traversing round 3/4" dia.

finishes available

material: aluminium

- A 79 aluminium
- B 77 stainless steel
- C 70 chromium (single rod only)

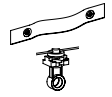

single rod

length (ft.)	rollers	brackets		1 1/2"			surcharge
				A	B	C	
3	16	2	\$	345	399	499	61
4	20	3		505	584	727	58
5	24	3		523	606	764	54
6	30	3		542	629	803	50
7	34	3		560	651	841	87
8	40	4		722	838	1070	82
9	44	4		740	860	1107	79
• 10	50	4		759	883	1146	74
11	54	4		777	905	1184	107
12	60	5		939	1092	1413	102
13	64	5		957	1113	1450	99
set-no. 14	68	5		975	1135	1488	136
15	74	5		994	1158	1527	131
Quantum 20 02291 16	78	6		1154	1344	1754	128
17	84	6		1174	1367	1793	123
18	88	6		1192	1389	1831	148

set without finials
finials see page 174

double rod

length (ft.)	rollers	brackets		1 1/2"	
				A	B
3	32	2	\$	479	556
4	40	3		694	805
5	48	3		730	848
6	60	3		770	895
7	68	3		806	938
8	80	4		1024	1191
9	88	4		1060	1234
• 10	100	4		1099	1281
11	108	4		1135	1324
12	120	5		1353	1577
13	128	5		1389	1620
set-no. 14	136	5		1425	1664
15	148	5		1464	1710
Quantum 20 02292 16	156	6		1679	1959
17	168	6		1718	2006
18	176	6		1754	2049

set without finials (for both rods)
finials see page 174

Notes

- rods in excess of 9ft. will be delivered in two sections

traversing round 3/4" dia.

finishes available

- A 50 white (Novum only)
79 aluminium
- B 77 stainless steel
- C 70 chromium

material: aluminium

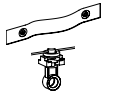

single rod

length (ft.)	rollers	brackets		1 1/4"			ripplefold surcharge	
				A	B	C		
3	16	2	\$	282	326	409	61	
4	20	3		410	475	592	58	
5	24	3		428	497	629	54	
6	30	3		448	520	668	50	
7	34	3		466	542	706	87	
8	40	4		596	692	890	82	
9	44	4		614	714	927	79	
• 10	50	4		633	737	966	74	
11	54	4		651	759	1004	107	
12	60	5		781	910	1188	102	
13	64	5		799	931	1225	99	
set-no.	14	68	5		817	953	1263	136
Votum 20	15	74	5		837	976	1302	131
02293	16	78	6		965	1125	1484	128
	17	84	6		985	1149	1523	123
	18	88	6		1003	1170	1561	148

set without
finials

finials see
page 174

set-no.

Votum 20 02293

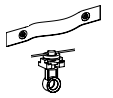

single rod

length (ft.)	rollers	brackets		1 5/16"			ripplefold surcharge	
				A	B	C		
3	16	2	\$	345	399	499	61	
4	20	3		505	584	727	58	
5	24	3		523	606	764	54	
6	30	3		542	629	803	50	
7	34	3		560	651	841	87	
8	40	4		722	838	1070	82	
9	44	4		740	860	1107	79	
• 10	50	4		759	883	1146	74	
11	54	4		777	905	1184	107	
12	60	5		939	1092	1413	102	
13	64	5		957	1113	1450	99	
set-no.	14	68	5		975	1135	1488	136
Novum 20	15	74	5		994	1158	1527	131
02299	16	78	6		1154	1344	1754	128
	17	84	6		1174	1367	1793	123
	18	88	6		1192	1389	1831	148

set without
finials

finials see
page 174

set-no.

Novum 20 02299

Notes

- rods in excess of 9ft. will be delivered in two sections

finishes available

50 white 56 black 70 chromium 77 stainless steel 79 aluminium

60 polished brass 62 brushed brass 72 brushed nickel 80 antique bronzed

corpus 20 79 aluminium
with finial Metro



corpus 20 62 brushed brass
with finial Xenon



corpus 20 77 stainless steel
with finial Retro



scale 1:1



traversing round 3/4" dia.

finishes available

material: aluminium

- | | | | |
|----------|--------------------|----------|--------------------|
| A | 50 white | C | 60 polished brass |
| | 56 black | | 77 stainless steel |
| | 79 aluminium | D | 70 chromium |
| B | 62 brushed brass | | |
| | 72 brushed nickel | | |
| | 80 antique bronzed | | |

single rod



length →

set-no.

Corpus 20 02294

set without finials

finials see below

length rollers brackets

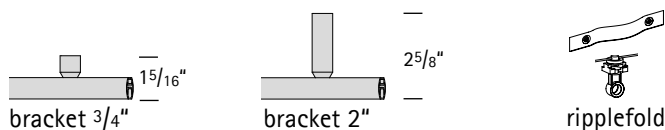

(ft.)	length	rollers	brackets		bracket 3/4"				bracket 2"				surcharge
					A	B	C	D	A	B	C	D	
3	16	2		\$	162	176	187	259	182	200	212	286	61
4	20	3			231	251	266	366	260	288	303	406	58
5	24	3			249	269	288	403	278	306	325	444	54
6	30	3			269	289	311	442	298	326	348	483	50
7	34	3			287	307	333	480	316	344	370	520	87
8	40	4			357	384	413	588	396	433	463	642	82
9	44	4			375	402	435	626	414	451	485	680	79
• 10	50	4			394	421	458	665	434	471	508	719	74
11	54	4			412	439	480	702	452	489	530	756	107
12	60	5			483	516	561	811	532	578	623	879	102
13	64	5			501	534	582	848	550	596	644	916	99
14	68	5			519	552	604	886	568	614	666	953	136
15	74	5			538	572	627	925	587	634	689	992	131
16	78	6			607	647	706	1032	666	722	781	1113	128
17	84	6			627	667	730	1071	685	741	804	1152	123
18	88	6			645	685	751	1108	703	759	826	1189	148

• rods in excess of 9ft. will be delivered in two sections

components

part

part-no. color-no.

price



3/4"

traversing rod 3/4" dia.
material: aluminium

30570

- | | | |
|----|-----------------|------------------------------|
| 50 | white | Cut to measure
\$/lin ft. |
| 56 | black | |
| 60 | polished brass | |
| 62 | brushed brass | |
| 70 | chromium | |
| 72 | brushed nickel | |
| 77 | stainless steel | |
| 79 | aluminium | |
| 80 | antique bronzed | |

14.80

14.80

18.50

14.80

34.20

14.80

18.50

14.80

14.80

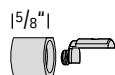

finial
Metro

21801

- | | |
|----|-----------------|
| 50 | white |
| 56 | black |
| 70 | chromium |
| 77 | stainless steel |
| 79 | aluminium |

33.80

33.80

56.30

38.90

33.80

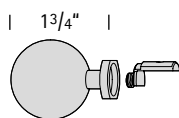

finial
Cosmo

21802

- | | |
|----|-----------------|
| 50 | white |
| 56 | black |
| 70 | chromium |
| 77 | stainless steel |
| 79 | aluminium |

69.80

69.80

97.80

80.40

69.80

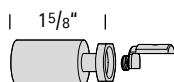

finial
Retro

21803

- | | |
|----|-----------------|
| 50 | white |
| 56 | black |
| 70 | chromium |
| 77 | stainless steel |
| 79 | aluminium |

69.80



69.80

97.80

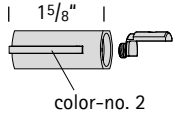

80.40

69.80

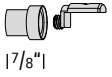
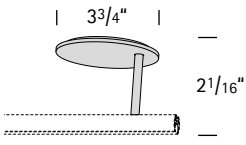
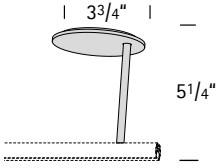
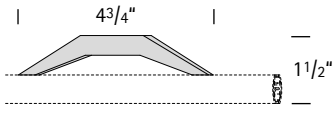
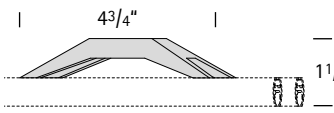
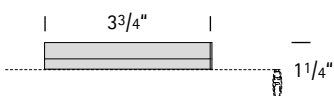
traversing round 3/4" dia.

components	part	part-no.	color-no.	price
	finial Duo	21804	77/56 stainless steel/black	76.50
			77/78 stainless steel/pol. aluminium	76.50
			79/56 aluminium/black	67.50
			79/78 aluminium/polished aluminium	67.50
	end cap Mono plastic	21829	50 white	5.70
			56 black	5.70
			60 pol. brass (also for brushed brass)	5.70
			70 chromium	5.70
			71 pol. nickel (also for brushed nickel)	5.70
			77 stainless steel	5.70
			79 aluminium	5.70
			80 antique bronzed	5.70
	end cap Xenon	21629	60 polished brass	38.00
			62 brushed brass	45.60
			72 brushed nickel	48.40
			80 antique bronzed	48.40
	ceiling bracket Zenit 3" can be shortened	21815	70 chromium	202.20
			77 stainless steel	173.60
			79 aluminium	150.90
	ceiling bracket Zenit 5" can be shortened for longer suspension please inquire	21816	70 chromium	246.10
			77 stainless steel	212.30
			79 aluminium	184.60
	ceiling bracket Quantum single rod	21716	70 chromium	190.20
			77 stainless steel	163.60
			79 aluminium	141.90
	ceiling bracket Quantum double rod distance between rods 2"	21726	77 stainless steel	205.90
			79 aluminium	178.90
	ceiling bracket Votum	21714	70 chromium	145.20
			77 stainless steel	127.20
			79 aluminium	110.40

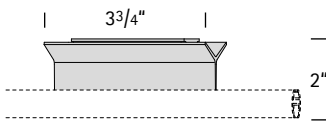
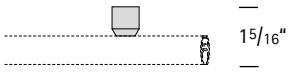
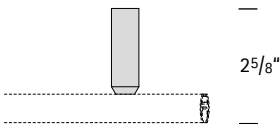

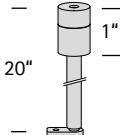
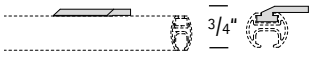
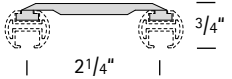

traversing round 3/4" dia.

components	part	part-no.	color-no.	price
	ceiling bracket Novum	22815	50 white	141.90
			70 chromium	190.20
			77 stainless steel	163.60
			79 aluminium	141.90
	ceiling bracket Corpus 3/4"	21614	50 white	50.70
			56 black	50.70
			60 polished brass	57.40
			62 brushed brass	57.40
			70 chromium	69.80
			72 brushed nickel	57.40
			77 stainless steel	57.40
			79 aluminium	50.70
			80 antique bronzed	57.40
				ceiling bracket Corpus 2"
56 black	60.50			
60 polished brass	69.80			
62 brushed brass	69.80			
70 chromium	83.30			
72 brushed nickel	69.80			
77 stainless steel	69.80			
79 aluminium	60.50			
80 antique bronzed	69.80			
	extension piece 3/4" for ceiling bracket 21614, 21616	21617		
			56 black	24.80
			60 polished brass	28.60
			62 brushed brass	28.60
			70 chromium	36.00
			72 brushed nickel	28.60
			77 stainless steel	28.60
			79 aluminium	24.80
			80 antique bronzed	28.60
	ceiling bracket 20" can be shortened	21615	50 white	93.40
			56 black	93.40
			60 polished brass	107.40
			62 brushed brass	107.40
			70 chromium	119.40
			72 brushed nickel	107.40
			77 stainless steel	107.40
			79 aluminium	93.40
			80 antique bronzed	107.40
	ceiling bracket close to ceiling shadow gap 1/8"	30514	50 white	20.00
			79 aluminium	20.00
	ceiling bracket close to ceiling for double rod shadow gap 1/8"	30524	50 white	33.30
			79 aluminium	33.30

traversing round 3/4" dia.

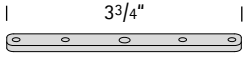
components	part	part-no.	color-no.	price		
	wall socket can be used at both ends	21705	50	white	49.50	
			56		black	49.50
			60		polished brass	63.00
			62		brushed brass	49.50
			70		chromium	72.00
			72		brushed nickel	49.50
			77		stainless steel	63.00
			79		aluminium	49.50
			80		antique bronzed	49.50
	roller with eyelet	30082	50	white	0.80	
	curtain hook	30080	50	white	0.20	
	runner for batons can be retrofitted	30078	50	white	3.60	
	stop clamp	30089	50	white	1.80	
	carriers with cord spacing between carriers 2 1/8" with easy snap for convenient installation	40 pcs 29085/40 60 pcs 29085/60 80 pcs 29085/80 100 pcs 29085/100 120 pcs 29085/120	50 50 50 50 50	white white white white white	52.00 78.00 104.00 130.00 156.00	
	ripplefold tape spacing between buttons 4 1/4" 100 % fullness spool 100 yards	29012	50 11	white transparent	413.60 413.60	
	ripplefold tape spacing between buttons 4 1/4" 100 % fullness cut to measure	29010	50 11	white transparent	per lin. ft. 1.70 per lin. ft. 1.70	

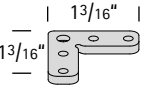
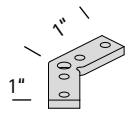
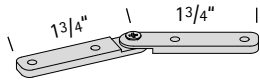
traversing round 3/4" dia.

components	part	part-no.	color-no.	price
	connector for bracket Zenit	30578	99	16.90
	connector for ceiling bracket Corpus	30577	99	16.90
	connector for brackets Quantum, Votum, Novum, 30514, 30524 (plastic)	21719	99	13.50
	corner connector 90° mitre cut \$ 43.00	30550	99	25.90
	corner connector 135° mitre cut \$ 43.00	30551	99	30.40
	corner connector flexibel mitre cut \$ 43.00	30552	99	59.70
	batons			see page 275
	accessories			see page 276

page 180



traversing
round

page 184

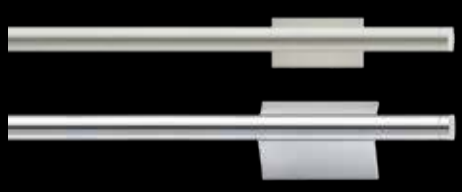

7/8"
dia.

log 2 stainless steel

lee 1 brushed nickel

luv 3 black



50 white

51 anthracite

56 black

70 chromium

72 brushed nickel

77 stainless steel

79 aluminium

lee 3 51 anthracite



luv 3 77 stainless steel



log 3 70 chromium



scale 1:1

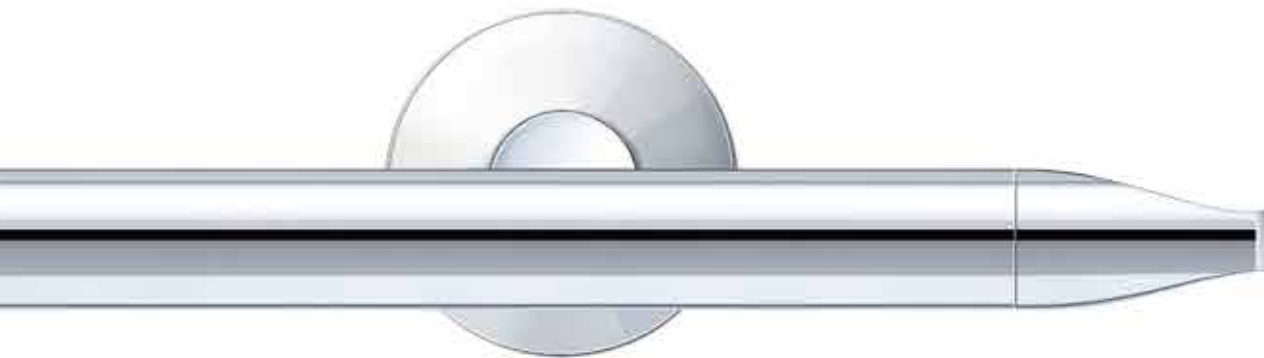

traversing round 7/8" dia.

finishes available

A	50 white	B	72 brushed nickel
	51 anthracite		77 stainless steel
	56 black	C	70 chromium
	79 aluminium		

material: aluminium

single rod



length \rightarrow $\frac{3}{8}$ "

set-no.
Lee 3 02330

length (ft.)	rollers	brackets	\$	bracket 3"			bracket 5"			bracket 7"			ripplefold surcharge	
				A	B	C	A	B	C	A	B	C		
3	16	2		326	378	484	346	401	512	367	424	540	61	
4	20	2		347	403	524	368	426	552	388	449	580	58	
5	24	2		369	429	565	389	451	592	409	475	620	54	
6	30	3		482	559	731	513	593	772	543	628	814	50	
7	34	3		504	584	771	534	618	812	564	653	855	87	
8	40	3		527	611	813	557	645	854	587	680	896	82	
9	44	3		548	636	853	579	670	894	609	705	937	79	
10	50	3		571	663	895	602	697	936	632	732	979	74	
11	54	4		683	791	1059	723	836	1115	764	883	1171	107	
12	60	4		706	818	1101	746	863	1156	787	910	1213	102	
13	64	4		727	843	1142	768	888	1197	808	935	1253	99	
14	68	4		748	868	1182	789	914	1237	830	960	1293	136	
15	74	4		771	895	1224	812	940	1279	853	987	1335	131	
16	78	4		793	920	1264	834	966	1319	874	1012	1376	128	
17	84	5		906	1051	1430	957	1107	1499	1008	1166	1570	123	
18	88	5		928	1076	1470	979	1132	1539	1029	1191	1610	148	
reduction per wall socket					74	83	99	84	94	113	94	106	127	

double rod

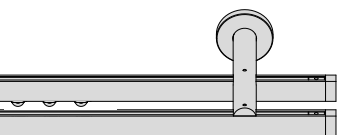

length \rightarrow $\frac{3}{8}$ "

set-no.
Lee 3 02333

length (ft.)	rollers	brackets	\$	bracket 3"			bracket 5"				
				A	B	C	A	B	C		
3	32	2		516	601	782	537	624	824		
4	40	2		559	651	862	580	674	904		
5	48	2		602	701	943	622	725	985		
6	60	3		761	884	1182	791	919	1245		
7	68	3		804	934	1262	834	969	1325		
8	80	3		850	988	1346	880	1023	1409		
9	88	3		892	1038	1427	923	1073	1490		
10	100	3		938	1092	1511	969	1127	1574		
11	108	4		1094	1271	1746	1135	1318	1830		
12	120	4		1140	1324	1830	1181	1371	1914		
13	128	4		1183	1375	1911	1224	1422	1995		
14	136	4		1226	1425	1991	1266	1472	2075		
15	148	4		1272	1479	2075	1312	1526	2159		
16	156	4		1314	1529	2156	1355	1576	2240		
17	168	5		1473	1712	2395	1524	1770	2500		
18	176	5		1516	1762	2475	1567	1820	2580		
reduction per wall socket					79	87	106	89	99	127	

Notes

• rods in excess of 9ft. will be delivered in two sections



accessories

see page 276

traversing round 7/8" dia.

finishes available

A 50 white
51 anthracite
56 black
79 aluminium

B 72 brushed nickel
77 stainless steel

C 70 chromium

material: aluminium

single rod



length →

Luv 3 02331
 Log 3 02332

length (ft.)	rollers	brackets		bracket 3"			bracket 5"			bracket 7"			ripplefold surcharge
				A	B	C	A	B	C	A	B	C	
3	16	2	\$	416	486	610	436	509	638	457	532	666	61
4	20	2		437	511	650	458	534	678	478	557	706	58
5	24	2		459	537	691	479	559	718	499	583	747	54
6	30	3		572	667	857	603	701	898	633	736	940	50
7	34	3		594	692	897	624	726	938	654	761	981	87
8	40	3		617	719	939	647	753	980	677	788	1023	82
9	44	3		638	744	979	669	778	1021	699	813	1063	79
• 10	50	3		661	771	1021	692	805	1063	722	840	1105	74
11	54	4		773	899	1186	813	944	1241	854	991	1297	107
12	60	4		796	926	1227	836	971	1283	877	1018	1339	102
13	64	4		817	951	1268	858	996	1323	898	1043	1379	99
set-no.	14	68	4	838	976	1308	879	1022	1363	920	1068	1420	136
	15	74	4	861	1003	1350	902	1048	1405	943	1095	1462	131
	16	78	4	883	1028	1390	924	1074	1445	964	1120	1502	128
	17	84	5	996	1159	1556	1047	1215	1625	1098	1274	1696	123
	18	88	5	1018	1184	1597	1069	1240	1666	1119	1299	1736	148
	reduction per wall socket			119	137	162	129	148	176	139	160	190	

double rod

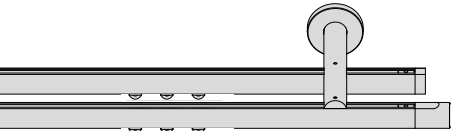

length →

Luv 3 02334
 Log 3 02335

length (ft.)	rollers	brackets		bracket 3"			bracket 5"		
				A	B	C	A	B	C
3	32	2	\$	606	709	908	627	732	950
4	40	2		649	759	988	670	782	1030
5	48	2		692	809	1069	712	833	1111
6	60	3		851	992	1308	881	1027	1371
7	68	3		894	1042	1389	924	1077	1452
8	80	3		940	1096	1472	970	1131	1535
9	88	3		982	1146	1553	1013	1181	1616
• 10	100	3		1028	1200	1637	1059	1235	1700
11	108	4		1184	1379	1872	1225	1426	1956
12	120	4		1230	1432	1956	1271	1479	2040
13	128	4		1273	1483	2037	1314	1530	2121
set-no.	14	136	4	1316	1533	2117	1356	1580	2201
	15	148	4	1362	1587	2201	1402	1634	2285
	16	156	4	1404	1637	2282	1445	1684	2366
	17	168	5	1563	1820	2521	1614	1878	2626
	18	176	5	1606	1870	2601	1657	1928	2706
	reduction per wall socket			124	141	169	134	153	190

Notes

• rods in excess of 9ft. will be delivered in two sections



accessories

see page 276

- 50 white
- 51 anthracite (flat brackets only)
- 70 chromium
- 72 brushed nickel
- 77 stainless steel
- 79 aluminium

lee 1 72 brushed nickel



lee 2 77 stainless steel



scale 1:1



page 194



page 198



page 202

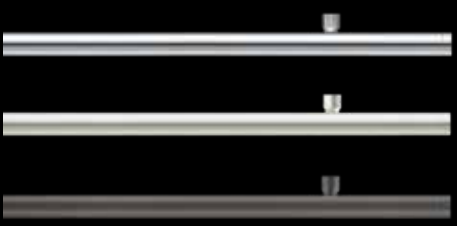

7/8"
dia.
ceiling

traversing
round

traversing round 7/8" dia.

finishes available

- A 50 white
79 aluminium
- B 72 brushed nickel
77 stainless steel
- C 70 chromium

material: aluminium

single rod

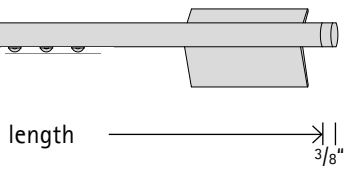

Lee 2 02339

length (ft.)	rollers	brackets	\$	bracket 33/4"			ripplefold surcharge
				A	B	C	
3	16	2		573	685	844	61
4	20	2		595	710	884	58
5	24	2		616	735	924	54
6	30	3		853	1019	1270	50
7	34	3		874	1044	1310	87
8	40	3		897	1071	1352	82
9	44	3		919	1096	1392	79
• 10	50	3		942	1123	1434	74
11	54	4		1177	1404	1779	107
12	60	4		1200	1431	1820	102
13	64	4		1221	1456	1861	99
set-no. 14	68	4		1243	1482	1901	136
15	74	4		1266	1508	1943	131
16	78	4		1287	1534	1983	128
17	84	5		1524	1817	2329	123
18	88	5		1546	1842	2369	148
reduction per wall socket				197	236	279	

single rod

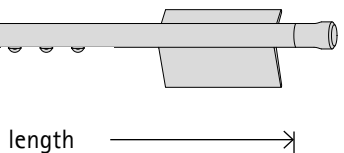

Luv 2 02340
Log 2 02341

length (ft.)	rollers	brackets	\$	bracket 33/4"			ripplefold surcharge
				A	B	C	
3	16	2		663	793	970	61
4	20	2		685	818	1010	58
5	24	2		706	843	1050	54
6	30	3		943	1127	1396	50
7	34	3		964	1152	1436	87
8	40	3		987	1179	1478	82
9	44	3		1009	1204	1519	79
• 10	50	3		1032	1231	1561	74
11	54	4		1267	1512	1905	107
12	60	4		1290	1539	1947	102
13	64	4		1311	1564	1987	99
set-no. 14	68	4		1333	1590	2027	136
15	74	4		1356	1616	2069	131
16	78	4		1377	1642	2109	128
17	84	5		1614	1925	2455	123
18	88	5		1636	1950	2496	148
reduction per wall socket				242	290	342	

Notes

- rods in excess of 9ft. will be delivered in two sections



accessories

see page 276

traversing round 7/8" dia.

finishes available

material: aluminium

- A 50 white
51 anthracite
79 aluminium
- B 72 brushed nickel
77 stainless steel
- C 70 chromium

single rod

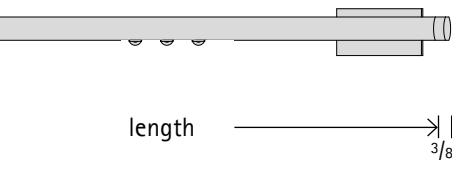

length

3/8"

set-no.

Lee 1

02336

length rollers brackets

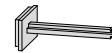

bracket 3"

bracket 5"

bracket 7"

ripplefold

(ft.)

	length (ft.)	rollers	brackets		bracket 3"			bracket 5"			bracket 7"			surcharge	
					A	B	C	A	B	C	A	B	C		
	3	16	2	\$	445	516	646	467	542	682	490	568	718	61	
	4	20	2		466	541	686	489	567	722	511	593	758	58	
	5	24	2		488	566	726	510	592	762	533	618	798	54	
	6	30	3		660	765	973	694	804	1027	728	843	1081	50	
	7	34	3		682	791	1013	715	829	1067	749	868	1121	87	
	8	40	3		705	817	1055	738	856	1109	772	895	1163	82	
	9	44	3		726	843	1095	760	881	1149	794	920	1203	79	
	• 10	50	3		749	869	1137	783	908	1191	817	947	1245	74	
	11	54	4		920	1067	1383	965	1118	1455	1010	1170	1527	107	
	12	60	4		943	1094	1424	988	1145	1496	1033	1197	1568	102	
	13	64	4		965	1119	1465	1009	1170	1537	1055	1222	1609	99	
	14	68	4		986	1144	1505	1031	1196	1577	1076	1248	1649	136	
	15	74	4		1009	1171	1547	1054	1222	1619	1099	1274	1691	131	
	16	78	4		1030	1196	1587	1075	1248	1659	1120	1300	1731	128	
	17	84	5		1203	1395	1834	1259	1460	1924	1316	1525	2014	123	
	18	88	5		1225	1420	1874	1281	1485	1964	1337	1550	2054	148	
	reduction per wall socket					133	152	180	144	164	198	155	177	216	

single rod

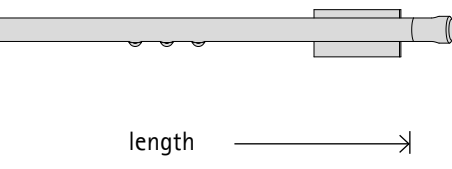

length

set-no.

Luv 1

02337

Log 1

02338

length rollers brackets

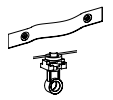
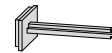

bracket 3"

bracket 5"

bracket 7"

ripplefold

(ft.)

	length (ft.)	rollers	brackets		bracket 3"			bracket 5"			bracket 7"			surcharge	
					A	B	C	A	B	C	A	B	C		
	3	16	2	\$	535	624	772	557	650	808	580	676	844	61	
	4	20	2		556	649	812	579	675	848	601	701	884	58	
	5	24	2		578	674	852	600	700	888	623	726	924	54	
	6	30	3		750	873	1099	784	912	1153	818	951	1207	50	
	7	34	3		772	899	1139	805	937	1193	839	976	1247	87	
	8	40	3		795	925	1181	828	964	1235	862	1003	1289	82	
	9	44	3		816	951	1222	850	989	1276	884	1028	1330	79	
	• 10	50	3		839	977	1264	873	1016	1318	907	1055	1372	74	
	11	54	4		1010	1175	1509	1055	1226	1581	1100	1278	1653	107	
	12	60	4		1033	1202	1551	1078	1253	1623	1123	1305	1695	102	
	13	64	4		1055	1227	1591	1099	1278	1663	1145	1330	1735	99	
	14	68	4		1076	1252	1631	1121	1304	1703	1166	1356	1775	136	
	15	74	4		1099	1279	1673	1144	1330	1745	1189	1382	1817	131	
	16	78	4		1120	1304	1713	1165	1356	1785	1210	1408	1857	128	
	17	84	5		1293	1503	1960	1349	1568	2050	1406	1633	2140	123	
	18	88	5		1315	1528	2001	1371	1593	2091	1427	1658	2181	148	
	reduction per wall socket					178	206	243	189	218	261	200	231	279	

Notes

- rods in excess of 9ft. will be delivered in two sections





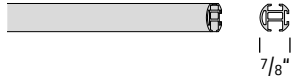
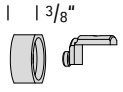
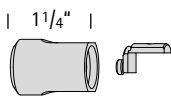
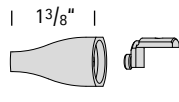
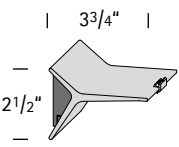
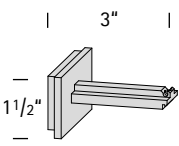
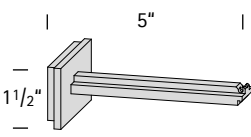
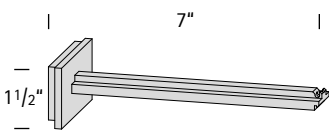

accessories

see page 276

traversing round 7/8" dia.

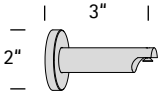
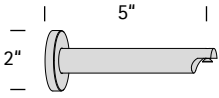
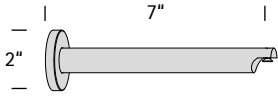
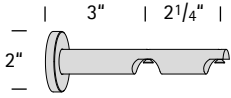
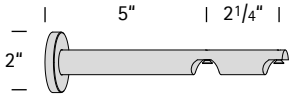
components	part	part-no.	color-no.	price			
	traversing rod 7/8" dia. material: aluminium	23670	50 white	Cut to measure \$ / lin ft.	18.20		
			51 anthracite		18.20		
			56 black		18.20		
			70 chromium		37.10		
			72 brushed nickel		22.00		
			77 stainless steel		22.00		
			79 aluminium		18.20		
					finial Lee also for double rod	23629	50 white
51 anthracite	37.20						
56 black	37.20						
70 chromium	54.00						
72 brushed nickel	44.60						
77 stainless steel	44.60						
79 aluminium	37.20						
	finial Luv	23601		50 white			82.20
			51 anthracite	82.20			
			56 black	82.20			
			70 chromium	117.10			
			72 brushed nickel	98.60			
			77 stainless steel	98.60			
			79 aluminium	82.20			
				finial Log	23602	50 white	82.20
51 anthracite	82.20						
56 black	82.20						
70 chromium	117.10						
72 brushed nickel	98.60						
77 stainless steel	98.60						
79 aluminium	82.20						
	bracket 3 3/4"	23631				50 white	213.90
			70 chromium	303.90			
			72 brushed nickel	256.60			
			77 stainless steel	256.60			
			79 aluminium	213.90			
				bracket flat 3"	28711	50 white	149.70
						51 anthracite	149.70
						70 chromium	204.90
72 brushed nickel	172.20						
77 stainless steel	172.20						
79 aluminium	149.70						
	bracket flat 5"	28712				50 white	160.90
						51 anthracite	160.90
			70 chromium	222.90			
			72 brushed nickel	185.10			
			77 stainless steel	185.10			
			79 aluminium	160.90			
				bracket flat 7"	28713	50 white	172.20
						51 anthracite	172.20
70 chromium	240.90						
72 brushed nickel	198.10						
77 stainless steel	198.10						
79 aluminium	172.20						

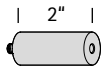

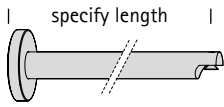
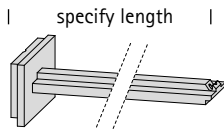
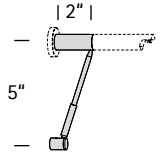
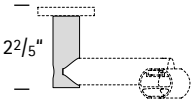
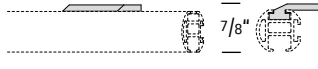
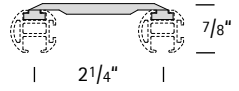
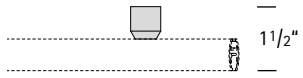
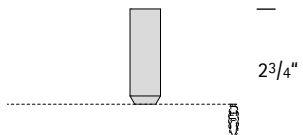

traversing round 7/8" dia.

components	part	part-no.	color-no.	price	
	bracket 3"	23611	50	white	90.30
			51	anthracite	90.30
			56	black	90.30
			70	chromium	124.10
			72	brushed nickel	103.30
			77	stainless steel	103.30
			79	aluminium	90.30
	bracket 5"	23612	50	white	100.50
			51	anthracite	100.50
			56	black	100.50
			70	chromium	137.90
			72	brushed nickel	114.60
			77	stainless steel	114.60
			79	aluminium	100.50
	bracket 7"	23613	50	white	110.60
			51	anthracite	110.60
			56	black	110.60
			70	chromium	152.00
			72	brushed nickel	126.30
			77	stainless steel	126.30
			79	aluminium	110.60
	double bracket 3"	23621	50	white	112.80
			51	anthracite	112.80
			56	black	112.80
			70	chromium	155.10
			72	brushed nickel	128.70
			77	stainless steel	128.70
			79	aluminium	112.80
	double bracket 5"	23622	50	white	123.00
			51	anthracite	123.00
			56	black	123.00
			70	chromium	176.10
			72	brushed nickel	140.40
			77	stainless steel	140.40
			79	aluminium	123.00
	extension piece 3/4"	21618	50	white	24.80
			51	anthracite	24.80
			56	black	24.80
			70	chromium	34.70
			72	brushed nickel	28.60
			77	stainless steel	28.60
			79	aluminium	24.80
	extension piece 2"	21619	50	white	30.40
			51	anthracite	30.40
			56	black	30.40
			70	chromium	42.50
			72	brushed nickel	35.80
			77	stainless steel	35.80
			79	aluminium	30.40
	extension piece 3"	21819	50	white	38.30
			51	anthracite	38.30
			56	black	38.30
			70	chromium	53.60
			72	brushed nickel	44.10
			77	stainless steel	44.10
			79	aluminium	38.30



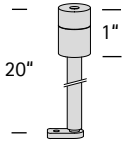

traversing round 7/8" dia.

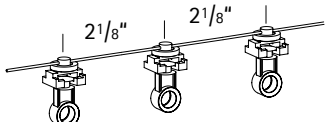
components	part	part-no.	color-no.	price
	shorten bracket service e.g. 23612-77-S-4"	S		surcharge 43.00
	shorten bracket service e.g. 28712-77-S-4"	S		surcharge 64.00
	bracket support incl. 2" bracket extension for brackets 23611-23622	21817	50 white 51 anthracite 56 black 70 chromium 72 brushed nickel 77 stainless steel 79 aluminium	162.10 162.10 162.10 222.90 186.40 186.40 162.10
	ceiling converter for ceiling mounts for single and double rod	21818	50 white 51 anthracite 56 black 70 chromium 72 brushed nickel 77 stainless steel 79 aluminium	58.50 58.50 58.50 82.00 67.30 67.30 58.50
	ceiling bracket close to ceiling shadow gap 1/8"	30514	50 white 79 aluminium	20.00 20.00
	ceiling bracket close to ceiling for double rod shadow gap 1/8"	30524	50 white 79 aluminium	33.30 33.30
	ceiling bracket 3/4"	21614	50 white 51 anthracite 56 black 70 chromium 72 brushed nickel 77 stainless steel 79 aluminium	50.70 50.70 50.70 69.80 57.40 57.40 50.70
	ceiling bracket 2"	21616	50 white 51 anthracite 56 black 70 chromium 72 brushed nickel 77 stainless steel 79 aluminium	60.50 60.50 60.50 83.30 69.80 69.80 60.50

traversing round 7/8" dia.

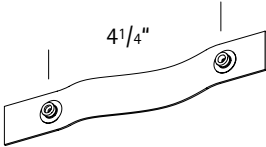
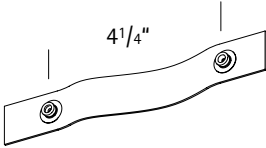
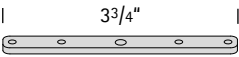
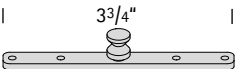
components	part	part-no.	color-no.	price		
	extension piece 3/4" for ceiling brackets 21614, 21616	21617	50	white	24.80	
			51	anthracite	24.80	
			56	black	24.80	
			70	chromium	36.00	
			72	brushed nickel	28.60	
			77	stainless steel	28.60	
			79	aluminium	24.80	
	ceiling bracket 20" can be shortened	21615	50	white	93.40	
			51	anthracite	93.40	
			56	black	93.40	
			70	chromium	119.40	
			72	brushed nickel	107.40	
			77	stainless steel	107.40	
	wall socket can be used at both ends	23605	50	white	54.00	
			51	anthracite	54.00	
			56	black	54.00	
			70	chromium	78.80	
			72	brushed nickel	65.30	
			77	stainless steel	65.30	
	roller with eyelet	30082	50	white	0.80	
	curtain hook	30080	50	white	0.20	
	runner for batons can be retrofitted	30078	50	white	3.60	
	stop clamp	30089	50	white	1.80	
	carriers with cord spacing between carriers 2 1/8" with easy snap for convenient installation	40 pcs	29085/40	50	white	52.00
		60 pcs	29085/60	50	white	78.00
		80 pcs	29085/80	50	white	104.00
		100 pcs	29085/100	50	white	130.00
		120 pcs	29085/120	50	white	156.00

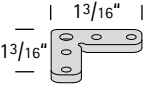
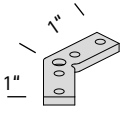
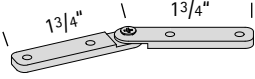
traversing round 7/8" dia.

components	part	part-no.	color-no.	price
	ripplefold tape spacing between buttons 4 1/4" 100 % fullness spool 100 yards	29012	50 11 white transparent	413.60 413.60
	ripplefold tape spacing between buttons 4 1/4" 100 % fullness cut to measure	29010	50 11 white transparent	per lin. ft. 1.70 per lin. ft. 1.70
	connector	30578	99	16.90
	connector for ceiling brackets 21614, 21616	30577	99	16.90
	connector for brackets 30514, 30524 (plastic)	21719	99	13.50
	corner connector 90° mitre cut \$ 43.00	30550	99	25.90
	corner connector 135° mitre cut \$ 43.00	30551	99	30.40
	corner connector flexible mitre cut \$ 43.00	30552	99	59.70
	batons		see page 275	
	accessories		see page 276	

price list 2018

zenit 22 stainless steel

finishes available

70 chromium

77 stainless steel

79 aluminium



zenit 22

77 stainless steel



scale 1:1

traversing round 7/8" dia.



traversing rod 7/8" dia.

finishes available

- A 79 aluminium
- B 77 stainless steel
- C 70 chromium

material: aluminium

single rod

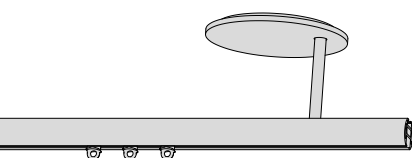

length →

set-no.

Zenit 22 02219

set without finials
finials see below

length rollers brackets

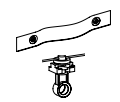
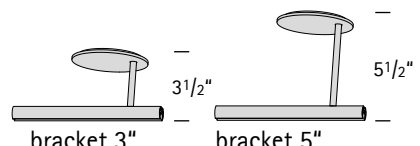

ripplefold

(ft.)				bracket 3"			bracket 5"			surcharge
				A	B	C	A	B	C	
3	16	2	\$	373	430	532	440	507	620	61
4	20	2		394	455	572	462	532	660	58
5	24	3		567	654	815	668	770	947	54
6	30	3		590	680	857	691	797	989	50
7	34	3		611	706	897	712	822	1029	87
8	40	3		634	732	939	735	849	1071	82
9	44	4		806	931	1182	941	1086	1357	79
• 10	50	4		829	958	1223	964	1113	1399	74
11	54	4		851	983	1264	985	1138	1439	107
12	60	4		874	1010	1306	1008	1165	1481	102
13	64	4		895	1035	1346	1030	1190	1522	99
14	68	5		1067	1234	1588	1236	1428	1808	136
15	74	5		1090	1261	1630	1259	1454	1850	131
16	78	5		1112	1286	1671	1280	1480	1890	128
17	84	5		1135	1313	1713	1303	1506	1932	123
18	88	5		1156	1338	1753	1325	1532	1972	148
reduction per wall socket				97	108	123	131	147	167	

• rods in excess of 9ft. will be delivered in two sections

components

part part-no. color-no. price

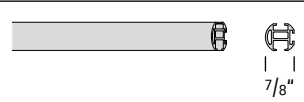

part	part-no.	color-no.	price
traversing rod 7/8" dia. material: aluminium	23670	70 chromium	Cut to measure \$/lin ft. 37.10
		77 stainless steel	
		79 aluminium	

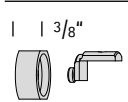

part	part-no.	color-no.	price
finial Lee	23629	70 chromium	54.00
		77 stainless steel	44.60
		79 aluminium	37.20

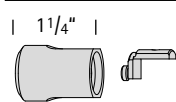

part	part-no.	color-no.	price
finial Luv	23601	70 chromium	117.10
		77 stainless steel	98.60
		79 aluminium	82.20

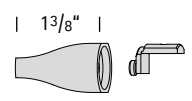

part	part-no.	color-no.	price
finial Log	23602	70 chromium	117.10
		77 stainless steel	98.60
		79 aluminium	82.20

novum 22 white



50 white
(Novum only)

51 anthracite
(Novum only)

70 chromium

72 brushed nickel
(Novum only)

77 stainless steel

79 aluminium



quantum 22 70 chromium



votum 22 77 stainless steel



novum 22 79 aluminium



scale 1:1

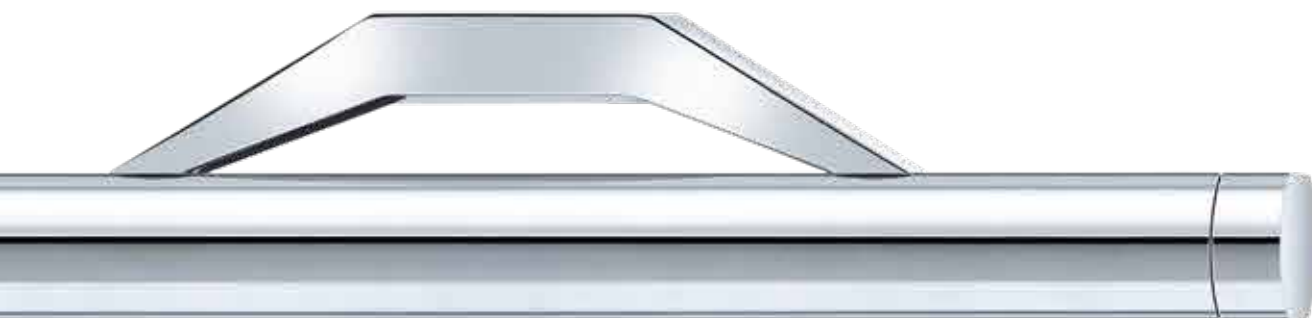

traversing round 7/8" dia.

finishes available

material: aluminium

- A 79 aluminium
- B 77 stainless steel
- C 70 chromium (single rod only)

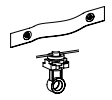

single rod

length rollers brackets

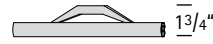

ripplefold

(ft.)				A	B	C	surcharge
3	16	2	\$	355	410	508	61
4	20	2		376	435	548	58
5	24	3		540	624	779	54
6	30	3		563	650	821	50
7	34	3		584	676	861	87
8	40	3		607	702	903	82
9	44	4		770	891	1134	79
• 10	50	4		793	918	1175	74
11	54	4		815	943	1216	107
12	60	4		838	970	1258	102
13	64	4		859	995	1298	99
14	68	5		1022	1184	1528	136
15	74	5		1045	1211	1570	131
16	78	5		1067	1236	1611	128
17	84	5		1090	1263	1653	123
18	88	5		1111	1288	1693	148

length →

set-no.

Quantum 22 02220

set without
finials

finials see
page 204

double rod

length rollers brackets



(ft.)				A	B
3	32	2	\$	500	577
4	40	2		543	627
5	48	3		764	883
6	60	3		810	937
7	68	3		853	987
8	80	3		899	1041
9	88	4		1121	1297
• 10	100	4		1167	1351
11	108	4		1210	1401
12	120	4		1256	1455
13	128	4		1298	1505
14	136	5		1520	1762
15	148	5		1566	1815
16	156	5		1609	1866
17	168	5		1655	1919
18	176	5		1698	1970

length →

set-no.

Quantum 22 02221

set without
finials (for both rods)

finials see
page 204

Notes

- rods in excess of 9ft. will be delivered in two sections

traversing round 7/8" dia.

finishes available

material: aluminium

- A 50 white (Novum only)
- 51 anthracite (Novum only)
- 79 aluminium
- B 72 brushed nickel (Novum only)
- 77 stainless steel
- C 70 chromium

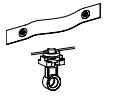

single rod

length rollers brackets 13/16"

ripplefold

(ft.)				A	B	C	surcharge
3	16	2	\$	292	337	418	61
4	20	2		313	362	458	58
5	24	3		445	514	644	54
6	30	3		468	541	686	50
7	34	3		489	566	726	87
8	40	3		512	593	768	82
9	44	4		644	746	954	79
• 10	50	4		667	772	995	74
11	54	4		689	798	1036	107
12	60	4		712	824	1078	102
13	64	4		733	850	1118	99
14	68	5		865	1002	1303	136
15	74	5		888	1029	1345	131
16	78	5		909	1054	1386	128
17	84	5		932	1081	1428	123
18	88	5		954	1106	1468	148

length →

set-no.

Votum 22 02222

set without
finials

finials see
page 204

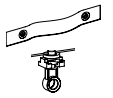

single rod

length rollers brackets 21/16"

ripplefold

(ft.)				A	B	C	surcharge
3	16	2	\$	355	410	508	61
4	20	2		376	435	548	58
5	24	3		540	624	779	54
6	30	3		563	650	821	50
7	34	3		584	676	861	87
8	40	3		607	702	903	82
9	44	4		770	891	1134	79
• 10	50	4		793	918	1175	74
11	54	4		815	943	1216	107
12	60	4		838	970	1258	102
13	64	4		859	995	1298	99
14	68	5		1022	1184	1528	136
15	74	5		1045	1211	1570	131
16	78	5		1067	1236	1611	128
17	84	5		1090	1263	1653	123
18	88	5		1111	1288	1693	148

length →

set-no.

Novum 22 02223

set without
finials

finials see
page 204



Notes

- rods in excess of 9ft. will be delivered in two sections

50 white

51 anthracite

56 black

70 chromium

72 brushed nickel

77 stainless steel

79 aluminium

corpus 22 77 stainless steel



corpus 22 72 brushed nickel



corpus 22 51 anthracite



scale 1:1



traversing rod 7/8" dia.

finishes available

- | | | | |
|----------|---------------|----------|--------------------|
| A | 50 white | B | 72 brushed nickel |
| | 51 anthracite | | 77 stainless steel |
| | 56 black | C | 70 chromium |
| | 79 aluminium | | |

material: aluminium

single rod



length →

set-no.

Corpus 22 02224

set without
finials
finials see
below



length rollers brackets

(ft.)

	length (ft.)	rollers	brackets	\$	bracket 3/4"			bracket 2"			surcharge
					A	B	C	A	B	C	
	3	16	2		172	197	267	192	222	294	61
	4	20	2		194	222	308	213	247	335	58
	5	24	3		266	305	418	295	342	458	54
	6	30	3		289	332	460	318	369	500	50
	7	34	3		310	357	500	340	394	540	87
	8	40	3		333	384	542	363	421	582	82
	9	44	4		405	466	652	445	516	706	79
	• 10	50	4		428	493	694	468	543	748	74
	11	54	4		450	518	734	489	568	788	107
	12	60	4		473	545	776	512	595	830	102
	13	64	4		494	570	816	533	620	870	99
	14	68	5		566	653	926	615	715	994	136
	15	74	5		589	680	968	638	742	1036	131
	16	78	5		611	705	1009	660	767	1076	128
	17	84	5		634	732	1051	683	794	1118	123
	18	88	5		655	757	1091	704	819	1158	148

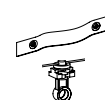
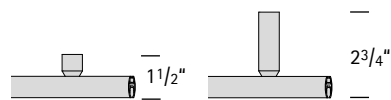

ripplefold

• rods in excess of 9ft. will be delivered in two sections

components

part

part-no. color-no.

price

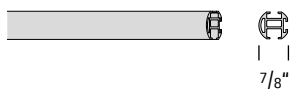

traversing rod 7/8" dia.
material: aluminium

23670

- 50 white
- 51 anthracite
- 56 black
- 70 chromium
- 72 brushed nickel
- 77 stainless steel
- 79 aluminium

Cut to measure \$/lin ft.	18.20
	18.20
	18.20
	37.10
	22.00
	22.00
	18.20

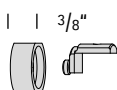

finial
Lee

23629

- 50 white
- 51 anthracite
- 56 black
- 70 chromium
- 72 brushed nickel
- 77 stainless steel
- 79 aluminium

37.20
37.20
37.20
54.00
44.60
44.60
37.20

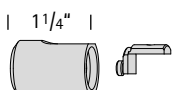

finial
Luv

23601

- 50 white
- 51 anthracite
- 56 black
- 70 chromium
- 72 brushed nickel
- 77 stainless steel
- 79 aluminium

82.20
82.20
82.20
117.10
98.60
98.60
82.20

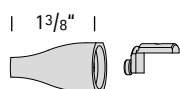



finial
Log

23602



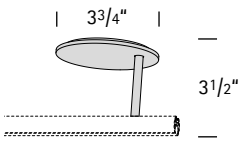
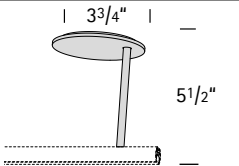
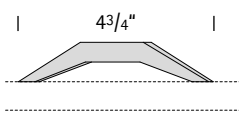
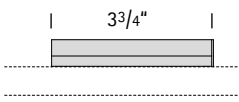
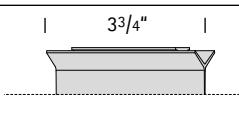
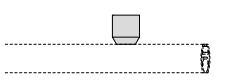
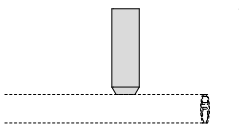

- 50 white
- 51 anthracite
- 56 black
- 70 chromium
- 72 brushed nickel
- 77 stainless steel
- 79 aluminium

82.20
82.20
82.20
117.10
98.60
98.60
82.20



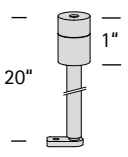
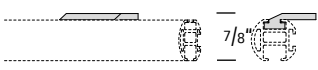
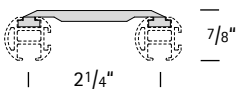
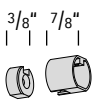

traversing round 7/8" dia.

components	part	part-no.	color-no.	price				
	ceiling bracket Zenit 3" can be shortened	21815	70 77 79	chromium stainless steel aluminium	202.20 173.60 150.90			
		ceiling bracket Zenit 5" can be shortened for longer suspension please inquire	21816	70 77 79	chromium stainless steel aluminium	246.10 212.30 184.60		
			ceiling bracket Quantum single rod	21716	70 77 79	chromium stainless steel aluminium	190.20 163.60 141.90	
			ceiling bracket Quantum double rod distance between rods 2"	21726	77 79	stainless steel aluminium	205.90 178.90	
	ceiling bracket Votum	21714	70 77 79	chromium stainless steel aluminium	145.20 127.20 110.40			
		ceiling bracket Novum	22815	50 51 70 72 77 79	white anthracite chromium brushed nickel stainless steel aluminium	141.90 141.90 190.20 163.60 163.60 141.90		
			ceiling bracket Corpus 3/4"	21614	50 51 56 70 72 77 79	white anthracite black chromium brushed nickel stainless steel aluminium	50.70 50.70 50.70 69.80 57.40 57.40 50.70	
			ceiling bracket Corpus 2"	21616	50 51 56 70 72 77 79	white anthracite black chromium brushed nickel stainless steel aluminium	60.50 60.50 60.50 83.30 69.80 69.80 60.50	
				extension piece 3/4" for ceiling bracket 21614, 21616	21617	50 51 56 70 72 77 79	white anthracite black chromium brushed nickel stainless steel aluminium	24.80 24.80 24.80 36.00 28.60 28.60 24.80

traversing round 7/8" dia.

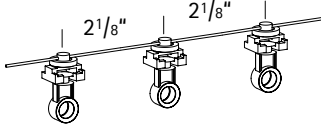
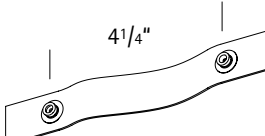
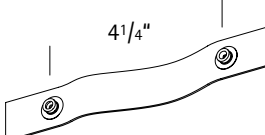
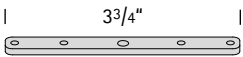
components	part	part-no.	color-no.	price
	ceiling bracket 20" can be shortened	21615	50 white	93.40
			51 anthracite	93.40
			56 black	93.40
			70 chromium	119.40
			72 brushed nickel	107.40
			77 stainless steel	107.40
			79 aluminium	93.40
				ceiling bracket close to ceiling shadow gap 1/8"
79 aluminium	20.00			
	ceiling bracket close to ceiling for double rod shadow gap 1/8"	30524	50 white	33.30
			79 aluminium	33.30
	wall socket can be used at both ends	23605	50 white	54.00
			51 anthracite	54.00
			56 black	54.00
			70 chromium	78.80
			72 brushed nickel	65.30
			77 stainless steel	65.30
			79 aluminium	54.00
				roller with eyelet
	curtain hook	30080	50 white	0.20
	runner for batons can be retrofitted	30078	50 white	3.60
	stop clamp	30089	50 white	1.80

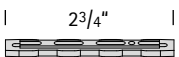
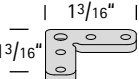
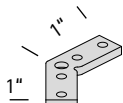
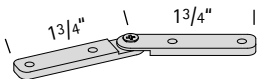
traversing round 7/8" dia.

components	part	part-no.	color-no.	price
	carriers with cord	40 pcs	29085/40 50	white 52.00
	spacing between	60 pcs	29085/60 50	white 78.00
	carriers 2 1/8"	80 pcs	29085/80 50	white 104.00
	with easy snap	100 pcs	29085/100 50	white 130.00
	for convenient installation	120 pcs	29085/120 50	white 156.00
	ripplefold tape	29012	50	white 413.60
	spacing between buttons 4 1/4" 100 % fullness spool 100 yards		11	transparent 413.60
	ripplefold tape	29010	50	white per lin. ft. 1.70
	spacing between buttons 4 1/4" 100 % fullness cut to measure		11	transparent per lin. ft. 1.70
	connector for bracket Zenit	30578	99	16.90
	connector for ceiling bracket Corpus	30577	99	16.90
	connector for brackets Quantum, Votum, Novum, 30514, 30524 (plastic)	21719	99	13.50
	corner connector 90° mitre cut \$ 43.00	30550	99	25.90
	corner connector 135° mitre cut \$ 43.00	30551	99	30.40
	corner connector flexible mitre cut \$ 43.00	30552	99	59.70
	batons			see page 275
	accessories			see page 276

page 210



page 216

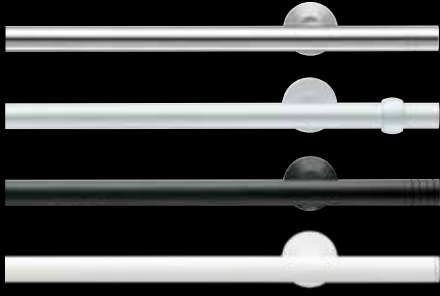

traversing
round

1"
dia.

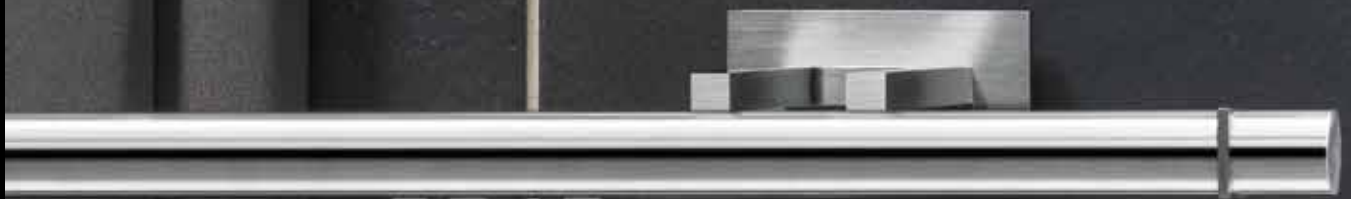

phantom 25 stainless steel



phantom 25 aluminium/polished aluminium



finishes available

77 stainless steel

79 aluminium

phantom 25 77 stainless steel



scale 1:1

traversing round 1" dia.



traversing round 1" dia.

finishes available

material: aluminium

- A 79 aluminium
- 79/78 aluminium/polished aluminium
- B 77 stainless steel
- 77/78 stainless steel/polished aluminium

single rod

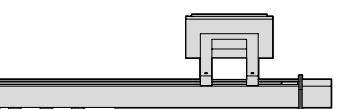

length → | 1 1/8" |

set-no. Phantom 25 02688

length (ft.)	rollers	brackets		bracket 3"		bracket 5"		ripplefold surcharge
				A	B	A	B	
3	16	2	\$	530	621	580	672	61
4	20	2		554	649	603	699	58
5	24	2		578	676	627	727	54
6	30	3		753	883	827	959	50
7	34	3		776	911	851	987	87
8	40	3		802	940	876	1016	82
9	44	3		825	967	900	1044	79
• 10	50	3		851	997	925	1073	74
11	54	4		1024	1202	1123	1303	107
12	60	4		1049	1231	1148	1333	102
13	64	4		1073	1259	1172	1360	99
set-no. 14	68	4		1097	1286	1196	1388	136
15	74	4		1122	1315	1221	1417	131
16	78	4		1146	1343	1245	1445	128
17	84	5		1321	1550	1444	1677	123
18	88	5		1345	1577	1468	1704	148
reduction per wall socket				170	201	195	226	

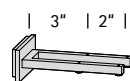
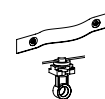

double rod

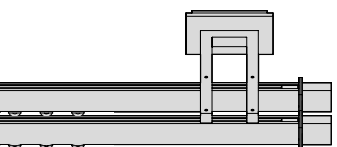

length → | 1 1/8" |

set-no. Phantom 25 02689

length (ft.)	rollers	brackets		bracket 3"	
				A	B
3	32	2	\$	836	967
4	40	2		883	1022
5	48	2		930	1077
6	60	3		1168	1354
7	68	3		1215	1409
8	80	3		1266	1467
9	88	3		1313	1522
• 10	100	3		1364	1581
11	108	4		1598	1854
12	120	4		1649	1912
13	128	4		1696	1967
set-no. 14	136	4		1744	2022
15	148	4		1794	2081
16	156	4		1842	2136
17	168	5		2079	2412
18	176	5		2127	2467
reduction per wall socket				227	264









Notes

- rods in excess of 9ft. will be delivered in two sections



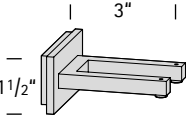
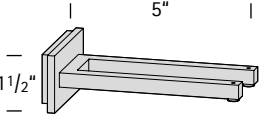
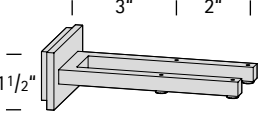
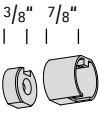
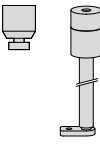

accessories see page 276

traversing round 1" dia.

components	part	part-no.	color-no.	price	
  	traversing rod 1" dia. material: aluminium	25670	77 79	stainless steel aluminium Cut to measure \$ / lin ft.	24.40 20.50
 color-no. 2	finial Phantom 25 also for double rod	26701	77 77/78 79 79/78	stainless steel stainless steel/pol. aluminium aluminium aluminium/polished aluminium	88.10 88.10 76.50 76.50
	bracket Phantom 3"	21711	77 79	stainless steel aluminium	177.60 149.70
	bracket Phantom 5"	21712	77 79	stainless steel aluminium	203.00 174.40
	double bracket Phantom 3"	21721	77 79	stainless steel aluminium	217.70 186.90
	wall socket can be used at both ends	26705	77 79	stainless steel aluminium	64.80 56.30
	ceiling bracket			see page 223	
	roller with eyelet	30082	50	white	0.80
	curtain hook	30080	50	white	0.20
	runner for batons can be retrofitted	30078	50	white	3.60

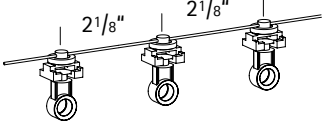
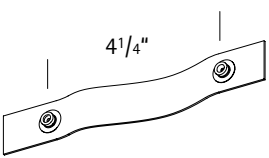
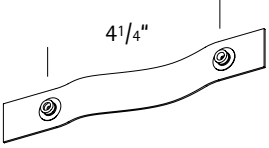
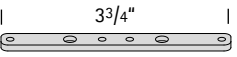
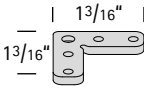
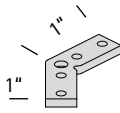
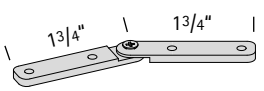
traversing round 1" dia.

components	part	part-no.	color-no.	price
	stop clamp	30089	50 white	1.80
	carriers with cord spacing between carriers 2 1/8" with easy snap for convenient installation	40 pcs 60 pcs 80 pcs 100 pcs 120 pcs	29085/40 50 white 29085/60 50 white 29085/80 50 white 29085/100 50 white 29085/120 50 white	52.00 78.00 104.00 130.00 156.00
	ripplefold tape spacing between buttons 4 1/4" 100 % fullness pool 100 yards	29012	50 white 11 transparent	413.60 413.60
	ripplefold tape spacing between buttons 4 1/4" 100 % fullness cut to measure	29010	50 white 11 transparent	per lin. ft. 1.70 per lin. ft. 1.70
	connector	30579	99	16.90
	corner connector 90° mitre cut \$ 43.00	30550	99	25.90
	corner connector 135° mitre cut \$ 43.00	30551	99	30.40
	corner connector flexible mitre cut \$ 43.00	30552	99	59.70
	batons		see page 275	
	accessories		see page 276	



radius stainless steel

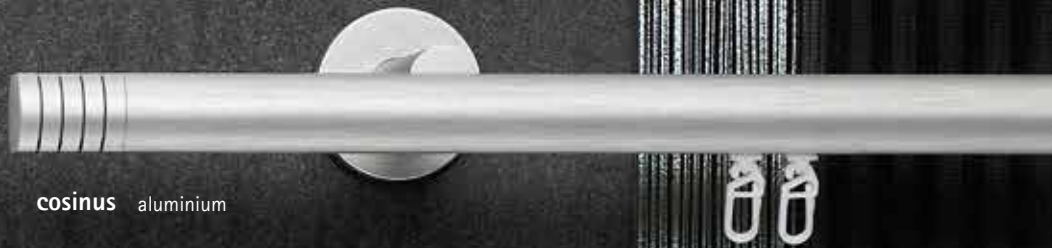

cosinus aluminium



sinus black

finishes available

50 white

56 black

77 stainless steel

79 aluminium

sinus 77 stainless steel



radius 79 aluminium



cosinus 56 black



modus 50 white



scale 1:1

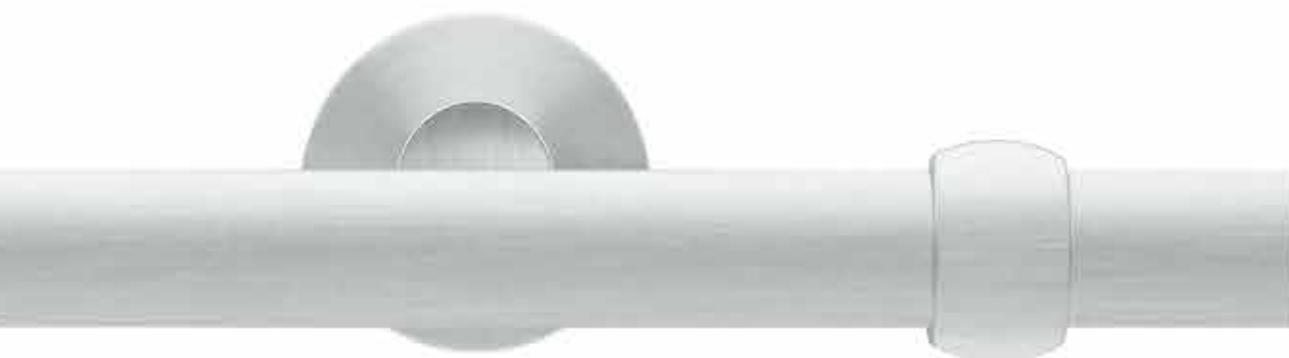

traversing round 1" dia.

finishes available

- A 50 white
- 56 black
- 79 aluminium
- B 77 stainless steel

material: aluminium (end cap plastic)

single rod

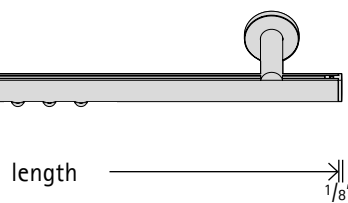

length → 1/8"

set-no. Modus 02680

length (ft.)	rollers	brackets		bracket 3"		bracket 5"		bracket 7"		ripplefold surcharge
				A	B	A	B	A	B	
3	16	2	\$	262	297	280	317	302	343	61
4	20	2		285	324	303	345	326	371	58
5	24	2		309	352	327	373	350	399	54
6	30	3		419	478	446	509	480	548	50
7	34	3		443	505	470	536	504	575	87
8	40	3		468	534	495	565	529	604	82
9	44	3		492	562	519	593	553	632	79
10	50	3		517	591	544	622	578	661	74
11	54	4		626	715	662	756	707	808	107
12	60	4		651	744	687	786	732	838	102
13	64	4		675	772	711	813	756	865	99
14	68	4		698	800	734	841	779	893	136
15	74	4		724	829	760	870	805	922	131
16	78	4		747	856	783	898	828	950	128
17	84	5		857	982	902	1034	959	1099	123
18	88	5		881	1010	926	1061	982	1126	148
reduction per wall socket				36	39	45	49	56	62	

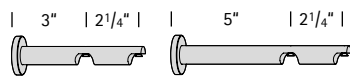

double rod

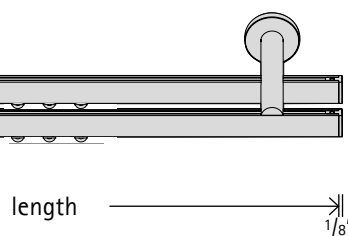

length → 1/8"

set-no. Modus 02684

length (ft.)	rollers	brackets		bracket 3"		bracket 5"	
				A	B	A	B
3	32	2	\$	397	450	419	476
4	40	2		444	505	467	531
5	48	2		492	561	514	586
6	60	3		648	740	682	779
7	68	3		696	795	729	834
8	80	3		746	854	780	892
9	88	3		794	909	827	948
10	100	3		844	967	878	1006
11	108	4		998	1144	1043	1195
12	120	4		1048	1202	1093	1254
13	128	4		1096	1257	1141	1309
14	136	4		1143	1312	1188	1364
15	148	4		1194	1371	1239	1422
16	156	4		1241	1426	1286	1478
17	168	5		1398	1606	1454	1670
18	176	5		1445	1661	1501	1725
reduction per wall socket				8	6	19	19

Notes

- rods in excess of 9ft. will be delivered in two sections



accessories see page 276

traversing round 1" dia.

finishes available

material: aluminium

- A 50 white
- 56 black
- 79 aluminium
- B 77 stainless steel

single rod



length



set-no.

□ Sinus

02681

length (ft.)	rollers	brackets		bracket 3"		bracket 5"		bracket 7"		ripplefold surcharge
				A	B	A	B	A	B	
3	16	2	\$	325	372	343	393	366	419	61
4	20	2		349	400	367	420	389	446	58
5	24	2		373	427	391	448	413	474	54
6	30	3		483	553	510	584	543	623	50
7	34	3		506	580	533	611	567	650	87
8	40	3		532	610	559	641	592	680	82
9	44	3		555	637	582	668	616	707	79
10	50	3	•	581	666	608	697	641	736	74
11	54	4		689	790	725	832	770	884	107
12	60	4		714	820	750	861	795	913	102
13	64	4		738	847	774	888	819	940	99
14	68	4		762	875	798	916	843	968	136
15	74	4		787	904	823	945	868	997	131
16	78	4		811	932	847	973	892	1025	128
17	84	5		921	1057	966	1109	1022	1174	123
18	88	5		944	1085	989	1136	1046	1201	148
reduction per wall socket				67	76	76	87	88	100	

double rod

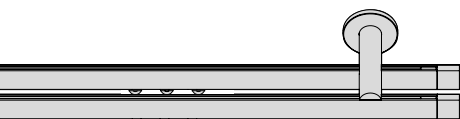

length



set-no.

□ Sinus

02685

length (ft.)	rollers	brackets		bracket 3"		bracket 5"	
				A	B	A	B
3	32	2	\$	524	601	546	626
4	40	2		571	656	593	682
5	48	2		618	711	641	737
6	60	3		775	891	809	929
7	68	3		823	946	856	984
8	80	3		873	1004	907	1043
9	88	3		921	1059	954	1098
10	100	3	•	971	1118	1005	1156
11	108	4		1125	1294	1169	1346
12	120	4		1175	1352	1220	1404
13	128	4		1223	1408	1267	1459
14	136	4		1270	1463	1315	1514
15	148	4		1321	1521	1365	1573
16	156	4		1368	1576	1413	1628
17	168	5		1525	1756	1581	1820
18	176	5		1572	1811	1628	1876
reduction per wall socket				71	81	83	94

Notes

- rods in excess of 9ft. will be delivered in two sections

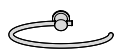

accessories see page 276

traversing round 1" dia.

finishes available



- A 50 white
- 56 black
- 79 aluminium
- B 77 stainless steel

material: aluminium

single rod



length →



-  Radius 02682
-  Cosinus 02683

length (ft.)	rollers	brackets		bracket 3"		bracket 5"		bracket 7"		ripplefold surcharge
				A	B	A	B	A	B	
3	16	2	\$	373	427	391	448	414	474	61
4	20	2		397	455	415	476	438	502	58
5	24	2		421	483	439	503	461	529	54
6	30	3		531	608	558	639	592	678	50
7	34	3		554	636	581	667	615	706	87
8	40	3		580	665	607	696	641	735	82
9	44	3		603	693	630	724	664	763	79
• 10	50	3		629	722	656	753	690	792	74
11	54	4		737	846	773	887	818	939	107
12	60	4		762	875	798	916	844	968	102
13	64	4		786	903	822	944	867	996	99
set-no. 14	68	4		810	930	846	971	891	1023	136
15	74	4		835	959	871	1001	916	1053	131
16	78	4		859	987	895	1028	940	1080	128
17	84	5		969	1113	1014	1164	1070	1229	123
18	88	5		993	1140	1038	1192	1094	1257	148
reduction per wall socket				91	104	100	114	112	127	

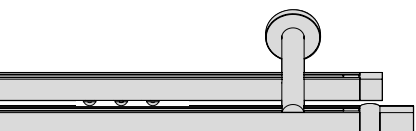
double rod



length →

-  Radius 02686
-  Cosinus 02687

length (ft.)	rollers	brackets		bracket 3"		bracket 5"	
				A	B	A	B
3	32	2	\$	572	656	594	682
4	40	2		619	711	642	737
5	48	2		667	766	689	792
6	60	3		823	946	857	985
7	68	3		871	1001	904	1040
8	80	3		921	1060	955	1098
9	88	3		969	1115	1002	1153
• 10	100	3		1019	1173	1053	1212
11	108	4		1173	1349	1218	1401
12	120	4		1223	1408	1268	1459
13	128	4		1271	1463	1316	1515
set-no. 14	136	4		1318	1518	1363	1570
15	148	4		1369	1577	1414	1628
16	156	4		1416	1632	1461	1683
17	168	5		1573	1811	1629	1876
18	176	5		1620	1867	1676	1931
reduction per wall socket				95	109	107	122



Notes

- rods in excess of 9ft. will be delivered in two sections



accessories see page 276

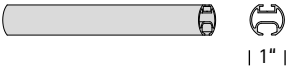
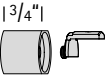
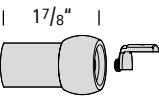
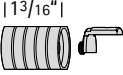

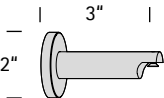
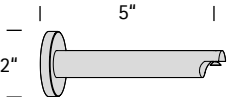
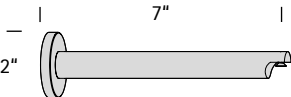
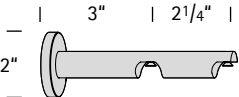
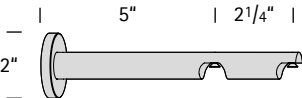

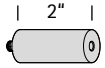
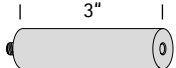
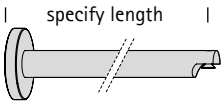
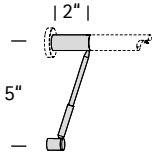
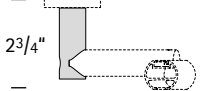
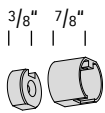
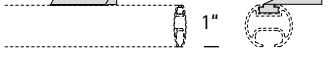
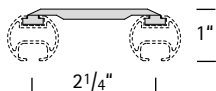

traversing round 1" dia.

components	part	set-no.	color-no.	price	
 1"	traversing rod 1" dia. material: aluminium	25670	50 white	<small>Cut to measure \$ / lin ft.</small> 20.50	
			56 black		20.50
			77 stainless steel		24.40
			79 aluminium		20.50
 3/4"	finial Sinus also end cap for double rod	26801	50 white	38.90	
			56 black	38.90	
			77 stainless steel	44.80	
			79 aluminium	38.90	
 1 7/8"	finial Radius	26802	50 white	63.00	
			56 black	63.00	
			77 stainless steel	72.50	
			79 aluminium	63.00	
 1 3/16"	finial Cosinus	26803	50 white	63.00	
			56 black	63.00	
			77 stainless steel	72.50	
			79 aluminium	63.00	
 1 1/8"	end cap Modus plastic	26829	50 white	7.20	
			56 black	7.20	
			77 stainless steel	7.20	
			79 aluminium	7.20	
 3"	bracket 3"	26811	50 white	84.70	
			56 black	84.70	
			77 stainless steel	96.40	
			79 aluminium	84.70	
 5"	bracket 5"	26812	50 white	93.70	
			56 black	93.70	
			77 stainless steel	106.70	
			79 aluminium	93.70	
 7"	bracket 7"	26813	50 white	105.00	
			56 black	105.00	
			77 stainless steel	119.70	
			79 aluminium	105.00	
 3" 2 1/4"	double bracket 3"	26821	50 white	106.10	
			56 black	106.10	
			77 stainless steel	121.10	
			79 aluminium	106.10	
 5" 2 1/4"	double bracket 5"	26822	50 white	117.30	
			56 black	117.30	
			77 stainless steel	134.00	
			79 aluminium	117.30	

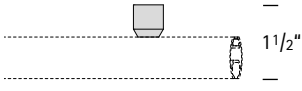
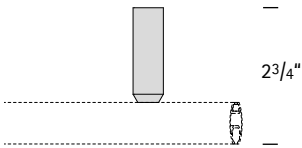

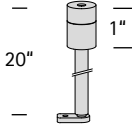
traversing round 1" dia.

components	part	part-no.	color-no.	price
	extension piece 3/4" for brackets and ceiling converter	21618	50 white	24.80
			56 black	24.80
			77 stainless steel	28.60
			79 aluminium	24.80
	extension piece 2" for brackets and ceiling converter	21619	50 white	30.40
			56 black	30.40
			77 stainless steel	35.80
			79 aluminium	30.40
	extension piece 3" for brackets and ceiling converter	21819	50 white	38.30
			56 black	38.30
			77 stainless steel	44.10
			79 aluminium	38.30
	shorten bracket service e.g. 26812-77-S-4"	S		surcharge 43.00
	bracket support incl. 2" bracket extension	21817	50 white	162.10
			56 black	162.10
			77 stainless steel	186.40
			79 aluminium	162.10
	ceiling converter for ceiling mounts for single and double rod	21818	50 white	58.50
			56 black	58.50
			77 stainless steel	67.30
			79 aluminium	58.50
	wall socket can be used at both ends	26705	50 white	56.30
			56 black	56.30
			77 stainless steel	64.80
			79 aluminium	56.30
	ceiling bracket close to ceiling shadow gap 1/8"	31514	50 white	21.40
			79 aluminium	21.40
	ceiling bracket close to ceiling for double rod shadow gap 1/8"	30524	50 white	33.30
			79 aluminium	33.30

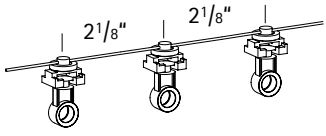
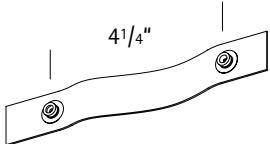
traversing round 1" dia.

components	part	part-no.	color-no.	price
	ceiling bracket 3/4"	21614	50 white	50.70
			56 black	50.70
			77 stainless steel	57.40
			79 aluminium	50.70
	ceiling bracket 2"	21616	50 white	60.50
			56 black	60.50
			77 stainless steel	69.80
			79 aluminium	60.50
	extension piece 3/4" for ceiling bracket 21614, 21616	21617	50 white	24.80
			56 black	24.80
			77 stainless steel	28.60
			79 aluminium	24.80
	ceiling bracket 20" can be shortened	21615	50 white	93.40
			56 black	93.40
			77 stainless steel	107.40
			79 aluminium	93.40
	roller with eyelet	30082	50 white	0.80
	curtain hook	30080	50 white	0.20
	runner for batons can be retrofitted	30078	50 white	3.60
	stop clamp	30089	50 white	1.80
	carriers with cord spacing between carriers 2 1/8" with easy snap for convenient installation	40 pcs	29085/40 50 white	52.00
		60 pcs	29085/60 50 white	78.00
		80 pcs	29085/80 50 white	104.00
		100 pcs	29085/100 50 white	130.00
		120 pcs	29085/120 50 white	156.00
	ripplefold tape spacing between buttons 4 1/4" 100 % fullness spool 100 yards	29012	50 white	413.60
			11 transparent	413.60

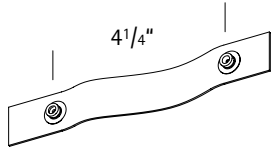
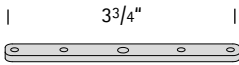
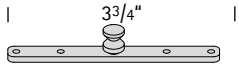
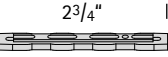
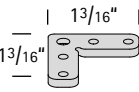
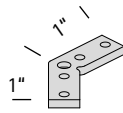
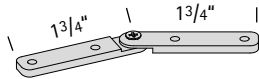
traversing round 1" dia.

components	part	part-no.	color-no.	price
	ripplefold tape spacing between buttons 4 1/4" 100 % fullness cut to measure	29010	50 11 white transparent	per lin. ft. 1.70 per lin. ft. 1.70
	connector for brackets 26811 - 26822	30578	99	16.90
	connector for ceiling brackets 21614, 21616	30577	99	16.90
	connector for brackets 31514, 30524 (plastic)	21719	99	13.50
	corner connector 90° mitre cut \$ 43.00	30550	99	25.90
	corner connector 135° mitre cut \$ 43.00	30551	99	30.40
	corner connector flexible mitre cut \$ 43.00	30552	99	59.70
	batons	see page 275		
	accessories	see page 276		



traversing round 1" dia.





zenit 25
with finial Sinus

79 aluminium

scale 1:1

traversing round 1" dia.



traversing round 1" dia.

finishes available

- A 79 aluminium
- B 77 stainless steel

material: aluminium

single rod

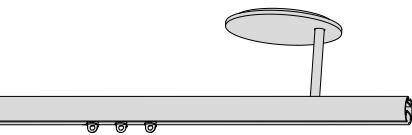

length →

set-no.

Zenit 25 02690

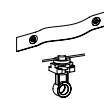
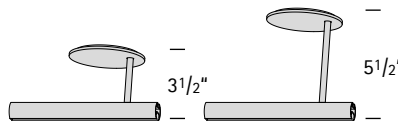

length (ft.)	rollers	brackets		bracket 3"		bracket 5"		ripplefold surcharge
				A	B	A	B	
3	16	2	\$	380	437	447	514	61
4	20	2		403	464	471	542	58
5	24	3		578	666	679	782	54
6	30	3		603	695	704	811	50
7	34	3		627	722	728	839	87
8	40	3		652	752	753	868	82
9	44	4		827	953	962	1108	79
• 10	50	4		852	982	987	1137	74
11	54	4		876	1010	1011	1164	107
12	60	4		901	1039	1036	1194	102
13	64	4		925	1066	1060	1221	99
14	68	5		1100	1268	1268	1461	136
15	74	5		1125	1297	1293	1490	131
16	78	5		1149	1324	1317	1518	128
17	84	5		1174	1354	1342	1547	123
18	88	5		1198	1381	1366	1575	148
reduction per wall socket				95	109	128	148	

set without
finials
finials see
below

- rods in excess of 9ft. will be delivered in two sections

components

components	part	set-no.	color-no.	price
<p>1 1/8" color-no. 2</p>	finial Phantom 25	26701	77 stainless steel	88.10
			77/78 stainless steel/pol. aluminium	88.10
			79 aluminium	76.50
			79/78 aluminium/polished aluminium	76.50
<p>3/4" </p>	finial Sinus	26801	77 stainless steel	44.80
			79 aluminium	38.90
<p>1 7/8" </p>	finial Radius	26802	77 stainless steel	72.50
			79 aluminium	63.00
<p>1 3/16" </p>	Endstück Cosinus	26803	77 stainless steel	72.50
			79 aluminium	63.00

rods, brackets, components

see page 236

page 226



page 230

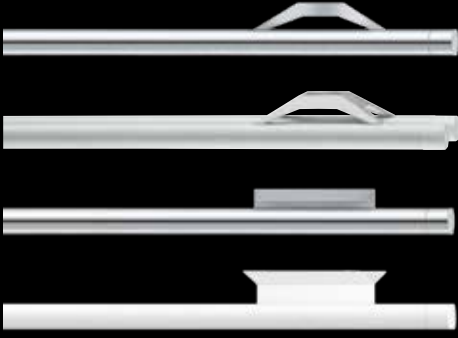

page 234



traversing
round

1"
dia.
ceiling

traversing round 1" dia.

quantum 25 stainless steel

finishes available

50 white
(Novum only)

77 stainless steel

79 aluminium



quantum 25 77 stainless steel



quantum 25 79 aluminium



votum 25 77 stainless steel



novum 25 50 white



scale 1:1



traversing round 1" dia.

finishes available

material: aluminium

A 79 aluminium

B 77 stainless steel

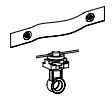

single rod

length rollers brackets 

ripplefold

(ft.)	rollers	brackets		A	B	surcharge
3	16	2	\$	362	417	61
4	20	2		385	444	58
5	24	3		551	636	54
6	30	3		576	665	50
7	34	3		600	692	87
8	40	3		625	722	82
9	44	4		791	913	79
• 10	50	4		816	942	74
11	54	4		840	970	107
12	60	4		865	999	102
13	64	4		889	1026	99
14	68	5		1055	1218	136
15	74	5		1080	1247	131
16	78	5		1104	1274	128
17	84	5		1129	1304	123
18	88	5		1153	1331	148

length →

set-no.

Quantum 25 02691

set without
finials

finials see
page 236



double rod

length rollers brackets 

(ft.)	rollers	brackets		A	B
3	32	2	\$	514	591
4	40	2		561	646
5	48	3		787	907
6	60	3		838	966
7	68	3		885	1021
8	80	3		936	1079
9	88	4		1162	1340
• 10	100	4		1213	1399
11	108	4		1260	1454
12	120	4		1311	1512
13	128	4		1358	1568
14	136	5		1585	1829
15	148	5		1635	1887
16	156	5		1683	1942
17	168	5		1733	2001
18	176	5		1781	2056

length →

set-no.

Quantum 25 02692

set without
finials (for both rods)

finials see
page 236

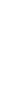

Notes

• rods in excess of 9ft. will be delivered in two sections

 batons see page 275

traversing round 1" dia.

finishes available

material: aluminium

- A 50 white (Novum only)
- 79 aluminium
- B 77 stainless steel

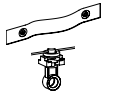

single rod

length rollers brackets 1 1/2"

ripplefold

(ft.)	rollers	brackets		A	B	surcharge
3	16	2	\$	299	344	61
4	20	2		322	372	58
5	24	3		457	526	54
6	30	3		482	556	50
7	34	3		506	583	87
8	40	3		531	612	82
9	44	4		665	767	79
• 10	50	4		690	796	74
11	54	4		714	824	107
12	60	4		739	853	102
13	64	4		763	881	99
14	68	5		897	1036	136
15	74	5		922	1065	131
16	78	5		946	1092	128
17	84	5		971	1122	123
18	88	5		995	1149	148

length →

set-no.

Votum 25 02693

set without finials

finials see page 236

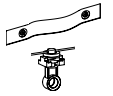

single rod

length rollers brackets 2 1/8"

ripplefold

(ft.)	rollers	brackets		A	B	surcharge
3	16	2	\$	362	417	61
4	20	2		385	444	58
5	24	3		551	636	54
6	30	3		576	665	50
7	34	3		600	692	87
8	40	3		625	722	82
9	44	4		791	913	79
• 10	50	4		816	942	74
11	54	4		840	970	107
12	60	4		865	999	102
13	64	4		889	1026	99
14	68	5		1055	1218	136
15	74	5		1080	1247	131
16	78	5		1104	1274	128
17	84	5		1129	1304	123
18	88	5		1153	1331	148

length →

set-no.

Novum 25 02695

set without finials

finials see page 236



Notes

- rods in excess of 9ft. will be delivered in two sections

batons see page 275

components see page 236

finishes available

50 white

56 black

77 stainless steel

79 aluminium

corpus 25 79 aluminium
with finial Sinus



corpus 25 56 black
with finial Sinus



corpus 25 77 stainless steel
with finial Radius



scale 1:1

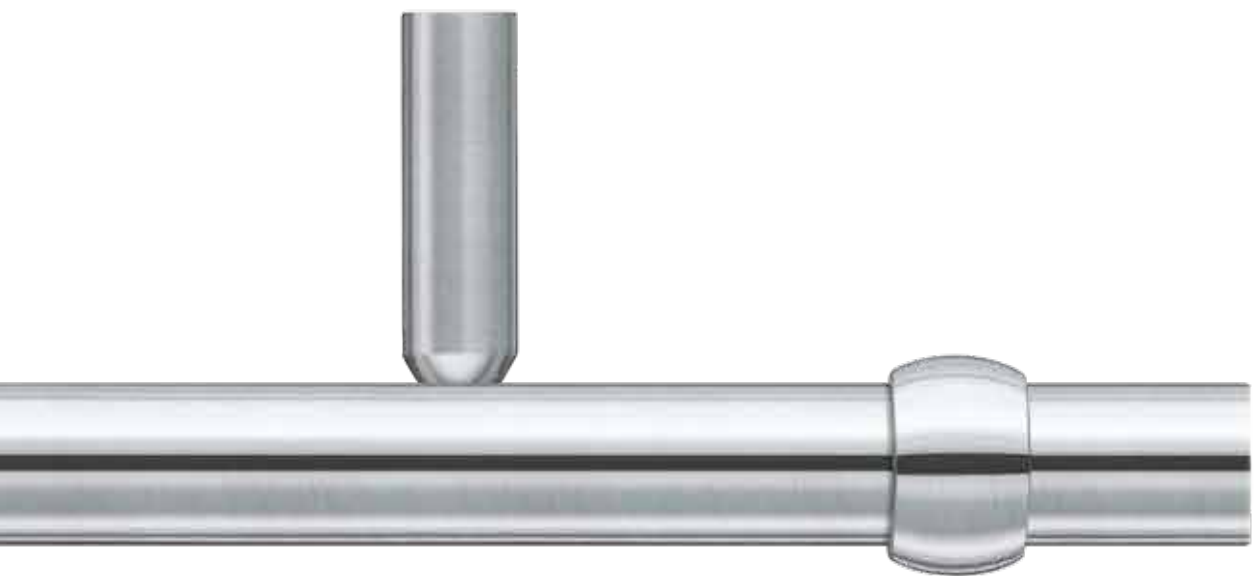

traversing round 1" dia.

finishes available

- A 50 white
- 56 black
- 79 aluminium
- B 77 stainless steel

material: aluminium

single rod

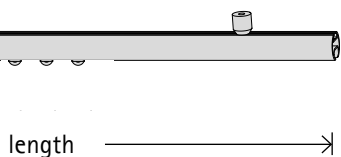

length (ft.)	rollers	brackets		bracket 3/4"		bracket 2"		ripplefold surcharge
				A	B	A	B	
3	16	2	\$	179	204	199	229	61
4	20	2		203	232	223	257	58
5	24	3		277	317	307	354	54
6	30	3		303	346	332	383	50
7	34	3		326	374	356	411	87
8	40	3		352	403	381	440	82
9	44	4		426	488	465	538	79
• 10	50	4		451	517	491	567	74
11	54	4		475	545	514	594	107
12	60	4		500	574	540	624	102
13	64	4		524	602	563	651	99
set-no. 14	68	5		599	687	648	749	136
15	74	5		624	716	673	778	131
Corpus 25 02694 16	78	5		648	743	697	805	128
17	84	5		673	773	722	835	123
18	88	5		697	800	746	862	148



set without
finials
finials see
below

• rods in excess of 9ft. will be delivered in two sections





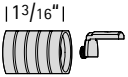

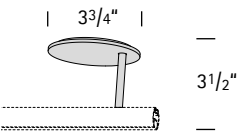
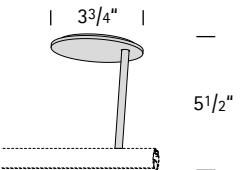
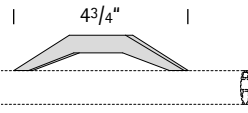
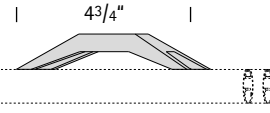
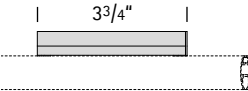
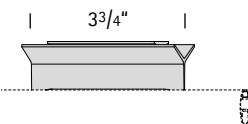
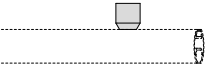
components

part	part-no.	color-no.	price
	traversing rod 1" dia. material: aluminium	50 white	Cut to measure \$/lin ft. 20.50
		56 black	
		77 stainless steel	
		79 aluminium	
	finial Phantom 25	26701 77 stainless steel	88.10
		77/78 stainless steel/pol. aluminium	88.10
		79 aluminium	76.50
		79/78 aluminium/polished aluminium	76.50
	finial Sinus	26801 50 white	38.90
		56 black	38.90
		77 stainless steel	44.80
		79 aluminium	38.90
	finial Radius	26802 50 white	63.00
		56 black	63.00
		77 stainless steel	72.50
		79 aluminium	63.00

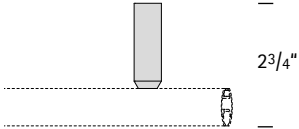

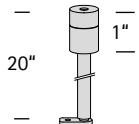
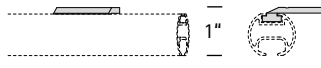
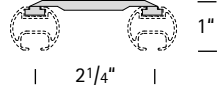
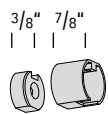

traversing round 1" dia.

components	part	part-no.	color-no.	price
 1 3/16"	finial Cosinus	26803	50 white	63.00
			56 black	63.00
			77 stainless steel	72.50
			79 aluminium	63.00
 1 1/8"	end cap Modus plastic	26829	50 white	7.20
			56 black	7.20
			77 stainless steel	7.20
			79 aluminium	7.20
 3 3/4" — 3 1/2"	ceiling bracket Zenit 3" can be shortened	21815	77 stainless steel	173.60
			79 aluminium	150.90
 3 3/4" — 5 1/2"	ceiling bracket Zenit 5" can be shortened for longer suspension please inquire	21816	77 stainless steel	212.30
			79 aluminium	184.60
 4 3/4" — 1 3/4"	ceiling bracket Quantum single rod	21716	77 stainless steel	163.60
			79 aluminium	141.90
 4 3/4" — 1 3/4"	ceiling bracket Quantum double rod distance between rods 2"	21726	77 stainless steel	205.90
			79 aluminium	178.90
 3 3/4" — 1 1/2"	ceiling bracket Votum	21714	77 stainless steel	127.20
			79 aluminium	110.40
 3 3/4" — 2 1/8"	ceiling bracket Novum	22815	50 white	141.90
			77 stainless steel	163.60
			79 aluminium	141.90
 — 1 1/2"	ceiling bracket Corpus 3/4"	21614	50 white	50.70
			56 black	50.70
			77 stainless steel	57.40
			79 aluminium	50.70

traversing round 1" dia.

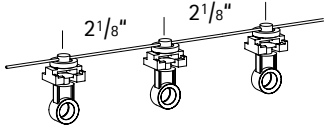
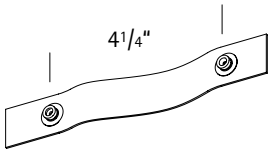
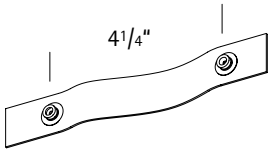
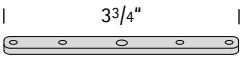
components	part	part-no.	color-no.	price
	ceiling bracket Corpus 2"	21616	56 black 77 stainless steel 79 aluminium	60.50 69.80 60.50
	extension piece 3/4" for ceiling bracket 21614, 21616	21617	50 white 56 black 77 stainless steel 79 aluminium	24.80 24.80 28.60 24.80
	ceiling bracket 20" can be shortened	21615	50 white 56 black 77 stainless steel 79 aluminium	93.40 93.40 107.40 93.40
	ceiling bracket close to ceiling shadow gap 1/8"	31514	50 white 79 aluminium	21.40 21.40
	ceiling bracket close to ceiling for double rod shadow gap 1/8"	30524	50 white 79 aluminium	33.30 33.30
	wall socket can be used at both ends	26705	50 white 56 black 77 stainless steel 79 aluminium	56.30 56.30 64.80 56.30
	roller with eyelet	30082	50 white	0.80
	curtain hook	30080	50 white	0.20
	runner for batons can be retrofitted	30078	50 white	3.60
	stop clamp	30089	50 white	1.80

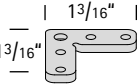
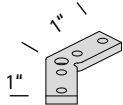
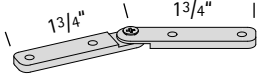
traversing round 1" dia.

components	part	part-no.	color-no.	price
	carriers with cord	40 pcs	29085/40 50	white 52.00
	spacing between	60 pcs	29085/60 50	white 78.00
	carriers 2 1/8"	80 pcs	29085/80 50	white 104.00
	with easy snap	100 pcs	29085/100 50	white 130.00
	for convenient installation	120 pcs	29085/120 50	white 156.00
	ripplefold tape	29012	50	white 413.60
	spacing between buttons 4 1/4" 100 % fullness spool 100 yards		11	transparent 413.60
	ripplefold tape	29010	50	white per lin. ft. 1.70
	spacing between buttons 4 1/4" 100 % fullness cut to measure		11	transparent per lin. ft. 1.70
	connector for bracket Zenit	30578	99	16.90
	connector for ceiling bracket Corpus	30577	99	16.90
	connector for brackets Quantum, Votum, Novum and 31514, 30524 (plastic)	21719	99	13.50
	corner connector 90° mitre cut \$ 43.00	30550	99	25.90
	corner connector 135° mitre cut \$ 43.00	30551	99	30.40
	corner connector flexible mitre cut \$ 43.00	30552	99	59.70
	batons	see page 275		

page 242

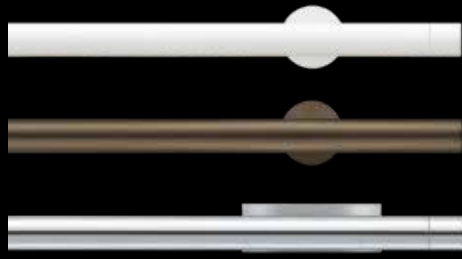

page 248

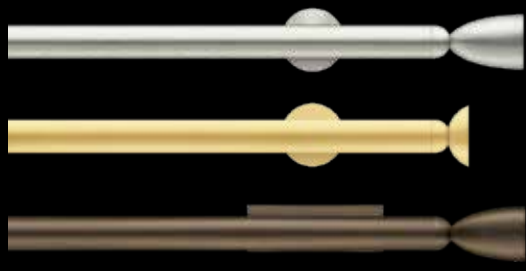

page 258



traversing
round

1³/₁₆"
dia.



sympathy 2 stainless steel



sympathy 2 aluminium



sympathy 1 black

finishes available

50 white 56 black 70 chromium 77 stainless steel 79 aluminium



62 brushed brass 72 brushed nickel 80 antique bronzed

sympathy 1 50 white

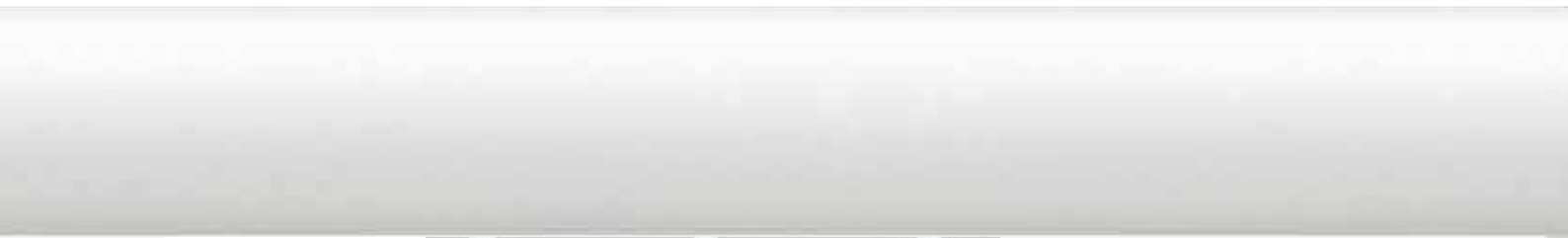

sympathy 1 80/64 antique bronzed/copper



sympathy 2 77 stainless steel



scale 1:1

traversing round 1³/₁₆" dia.



traversing round 1³/₁₆" dia.

finishes available

- A** 50 white
56 black
79 aluminium
- B** 62 brushed brass
72 brushed nickel

- B** 77 stainless steel
80 antique bronzed
80/64 antique bronzed/copper
- C** 70 chromium

material: aluminium

single rod

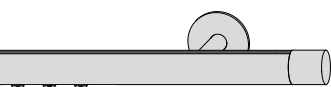

length → | 1³/₁₆"

set-no. **Sympathy 1** 03121

length rollers brackets

(ft.)

3	16	2
4	20	2
5	24	2
6	30	2
7	34	3
8	40	3
9	44	3
• 10	50	3
11	54	3
12	60	3
13	64	4
14	68	4
15	74	4
16	78	4
17	84	4
18	88	4

reduction per wall socket



brackets 3" or 5"



brackets 7" or 9"

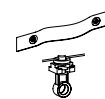

ripplefold

surcharge

	A	B	C	A	B	C	
\$	404	464	579	431	496	610	61
	433	497	624	460	529	656	58
	463	530	670	490	562	702	54
	494	565	717	521	596	749	50
	630	722	914	671	770	961	87
	661	757	961	702	805	1009	82
	691	790	1007	731	838	1054	79
	721	825	1054	762	872	1102	74
	751	858	1100	791	905	1147	107
	782	893	1147	822	940	1195	102
	918	1050	1344	972	1114	1407	99
	948	1083	1390	1002	1147	1453	136
	979	1118	1437	1033	1181	1500	131
	1008	1151	1483	1062	1214	1546	128
	1039	1186	1530	1093	1249	1593	123
	1068	1219	1576	1122	1282	1639	148
	92	106	130	105	122	145	

finishes available

- A** 50 white
56 black
79 aluminium
- B** 62 brushed brass
72 brushed nickel

- B** 80 antique bronzed
80/64 antique bronzed/copper
- C** 77 stainless steel
- D** 70 chromium

material: aluminium

double rod with traversing rod

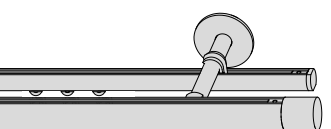

length → | 1³/₁₆"

set-no. **Sympathy 1** 03122

length rollers brackets

(ft.)

3	32	2
4	40	2
5	48	3
6	60	3
7	68	3
8	80	3
9	88	4
• 10	100	4
11	108	4
12	120	4
13	128	4
14	136	5
15	148	5
16	156	5
17	168	5
18	180	5

reduction per wall socket



brackets 3" or 5"



brackets 7" or 9"

	A	B	C	D	A	B	C	D
\$	488	548	559	720	515	579	590	752
	535	599	613	803	562	630	645	835
	695	780	798	1043	736	827	846	1091
	746	834	856	1130	786	882	904	1177
	793	885	911	1213	834	933	959	1260
	844	940	969	1299	884	987	1017	1346
	1004	1121	1154	1539	1058	1184	1217	1602
	1055	1175	1212	1625	1109	1238	1275	1688
	1102	1226	1267	1708	1156	1290	1330	1772
	1152	1281	1325	1795	1206	1344	1388	1858
	1200	1332	1380	1878	1254	1395	1443	1941
	1360	1513	1565	2118	1428	1592	1644	2197
	1411	1567	1623	2204	1478	1646	1702	2283
	1458	1618	1678	2287	1525	1697	1757	2366
	1508	1673	1736	2373	1576	1752	1815	2452
	1559	1727	1794	2460	1626	1806	1873	2539
	54	68	54	69	67	83	70	85

Notes

- rods in excess of 9ft. will be delivered in two sections



accessories see page 276

traversing round 1³/₁₆" dia.

finishes available

- A** 50 white
56 black
79 aluminium
- B** 62 brushed brass
72 brushed nickel

- B** 77 stainless steel
80 antique bronzed
80/64 antique bronzed/copper
- C** 70 chromium

material: aluminium

single rod (flat bracket)

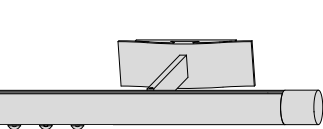

length → | 1³/₁₆"

set-no. **Sympathy 2** 03123

length (ft.)	rollers	brackets	\$	bracket 3"			bracket 5"			bracket 7"			ripplefold surcharge
				A	B	C	A	B	C	A	B	C	
3	16	2		520	595	740	538	616	765	556	637	790	61
4	20	2		549	628	785	567	649	811	585	670	836	58
5	24	2		579	662	831	597	682	856	615	703	881	54
6	30	2		610	696	878	628	717	904	646	738	929	50
7	34	3		804	920	1156	831	951	1194	858	982	1231	87
8	40	3		835	954	1203	862	985	1241	889	1017	1278	82
9	44	3		865	987	1249	892	1019	1287	919	1050	1324	79
• 10	50	3		895	1022	1296	922	1053	1334	949	1084	1371	74
11	54	3		925	1055	1342	952	1086	1380	979	1118	1417	107
12	60	3		956	1090	1389	983	1121	1427	1010	1152	1464	102
13	64	4		1150	1313	1666	1186	1355	1717	1222	1396	1767	99
14	68	4		1180	1346	1712	1216	1388	1763	1252	1429	1813	136
15	74	4		1211	1381	1759	1247	1423	1810	1283	1464	1860	131
16	78	4		1240	1414	1805	1276	1456	1856	1312	1497	1906	128
17	84	4		1271	1449	1852	1307	1490	1903	1343	1532	1953	123
18	88	4		1300	1482	1898	1336	1523	1949	1372	1565	1999	148
reduction per wall socket				150	171	210	159	182	223	168	192	235	

Notes

- rods in excess of 9ft. will be delivered in two sections

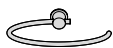

accessories see page 276

components see page 252



fantasy 2 brushed nickel



poetry 1 antique bronzed/copper



holdback
brushed nickel p. 276



finishes available

62 brushed brass

72 brushed nickel

80 antique bronzed

poetry 1 72 brushed nickel

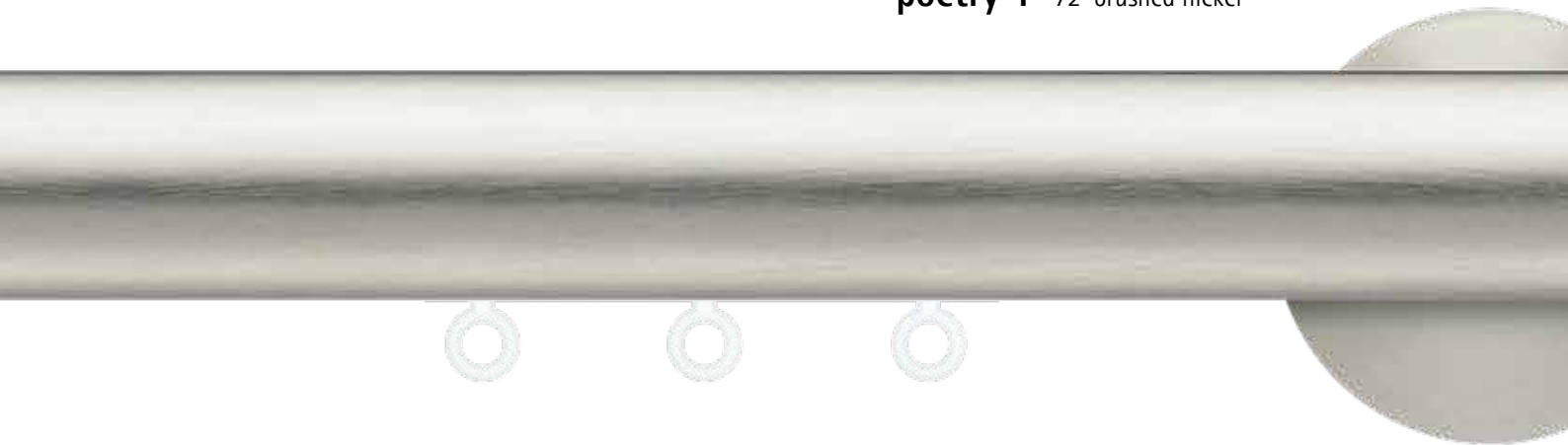

fantasy 1 62 brushed brass

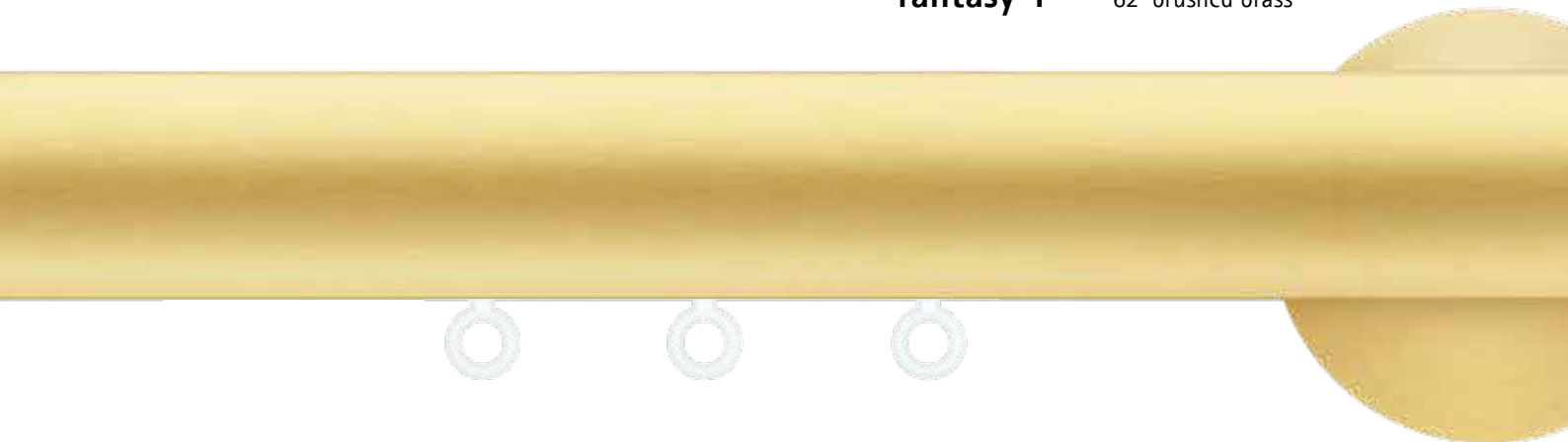

poetry 2 80 antique bronzed



scale 1:1

traversing round 1³/₁₆" dia.

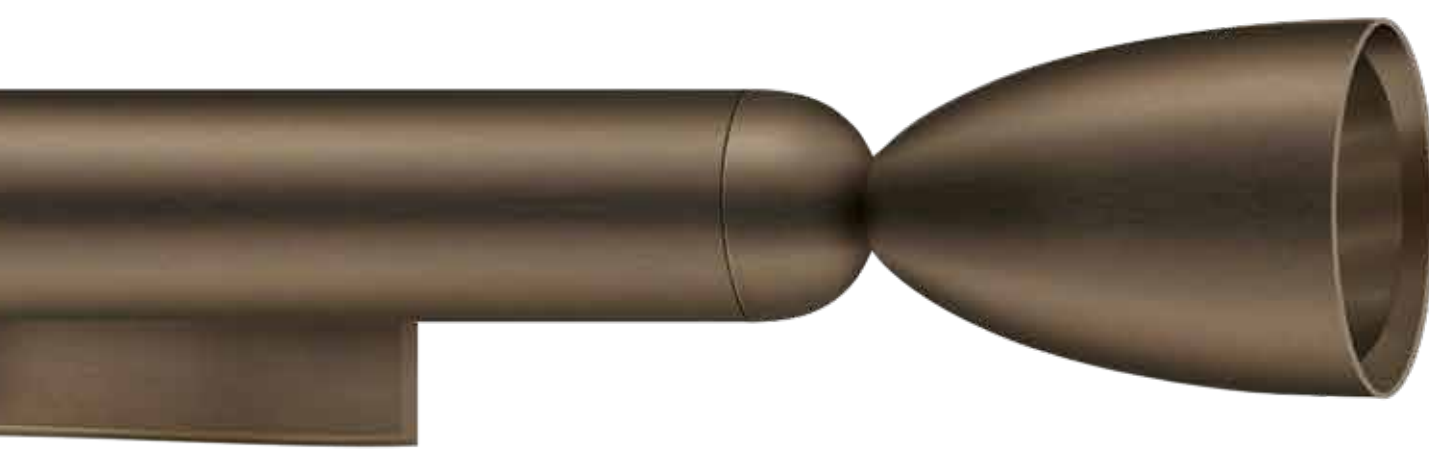

traversing round 1³/₁₆" dia.

finishes available



material: aluminium

- A 62 brushed brass
- 72 brushed nickel
- 80 antique bronzed
- B 80/64 antique bronzed/copper

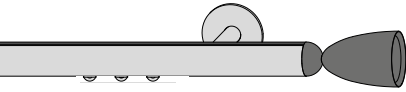
single rod



length →



-  Poetry 1 03124
-  Fantasy 1 03125

length (ft.)	rollers	brackets		brackets 3" or 5"		brackets 7" or 9"		ripplefold surcharge
				A	B	A	B	
3	16	2	\$	603	711	635	743	61
4	20	2		636	744	668	776	58
5	24	2		669	777	701	809	54
6	30	2		704	812	735	843	50
7	34	3		861	969	909	1017	87
8	40	3		896	1004	944	1052	82
9	44	3		929	1037	977	1085	79
• 10	50	3		964	1072	1011	1119	74
11	54	3		997	1105	1044	1152	107
12	60	3		1032	1140	1079	1187	102
13	64	4		1189	1297	1253	1361	99
set-no.	14	68	4	1222	1330	1286	1394	136
	15	74	4	1257	1365	1320	1428	131
	16	78	4	1290	1398	1353	1461	128
	17	84	4	1325	1433	1388	1496	123
	18	88	4	1358	1466	1421	1529	148
	reduction per wall socket				175 229	191 245		

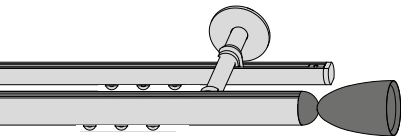
double rod with traversing rod



length →

-  Poetry 1 03127
-  Fantasy 1 03128

length (ft.)	rollers	brackets		brackets 3" or 5"		brackets 7" or 9"		
				A	B	A	B	
3	16	2	\$	687	795	718	826	
4	20	2		738	846	769	877	
5	24	3		919	1027	966	1074	
6	30	3		973	1081	1021	1129	
7	34	3		1024	1132	1072	1180	
8	40	3		1079	1187	1126	1234	
9	44	4		1260	1368	1323	1431	
• 10	50	4		1314	1422	1377	1485	
11	54	4		1365	1473	1429	1537	
12	60	4		1420	1528	1483	1591	
13	64	4		1471	1579	1534	1642	
set-no.	14	68	5	1652	1760	1731	1839	
	15	74	5	1706	1814	1785	1893	
	16	78	5	1757	1865	1836	1944	
	17	84	5	1812	1920	1891	1999	
	18	90	5	1866	1974	1945	2053	
	reduction per wall socket				137 191	153 207		

Notes

- rods in excess of 9ft. will be delivered in two sections



accessories see page 276

traversing round 1³/₁₆" dia.

finishes available

material: aluminium



- A 62 brushed brass
- 72 brushed nickel
- 80 antique bronzed

- B 80/64 antique bronzed/copper

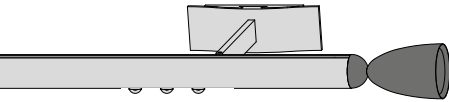
single rod (flat bracket)



length →

-  **Poetry 2** 03134
-  **Fantasy 2** 03135

length (ft.)	rollers	brackets		bracket 3"		bracket 5"		bracket 7"		ripplefold surcharge
				A	B	A	B	A	B	
3	16	2	\$	734	842	755	863	776	884	61
4	20	2		767	875	788	896	809	917	58
5	24	2		801	909	821	929	842	950	54
6	30	2		835	943	856	964	877	985	50
7	34	3		1059	1167	1090	1198	1121	1229	87
8	40	3		1093	1201	1124	1232	1156	1264	82
9	44	3		1126	1234	1158	1266	1189	1297	79
• 10	50	3		1161	1269	1192	1300	1223	1331	74
11	54	3		1194	1302	1225	1333	1257	1365	107
12	60	3		1229	1337	1260	1368	1291	1399	102
13	64	4		1452	1560	1494	1602	1535	1643	99
set-no.	14	68	4	1485	1593	1527	1635	1568	1676	136
	15	74	4	1520	1628	1562	1670	1603	1711	131
	16	78	4	1553	1661	1595	1703	1636	1744	128
	17	84	4	1588	1696	1629	1737	1671	1779	123
	18	88	4	1621	1729	1662	1770	1704	1812	148
	reduction per wall socket				241 295	251 305	262 316			

Notes

- rods in excess of 9ft. will be delivered in two sections





accessories see page 276

components see page 252

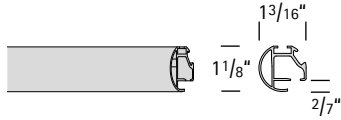
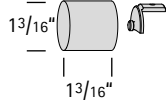
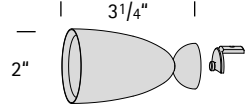
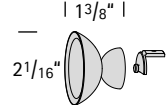
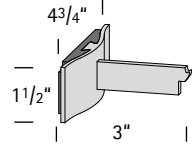
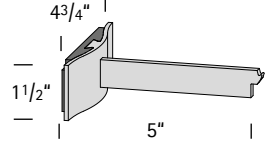
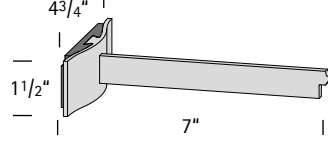

traversing round 1³/₁₆" dia.

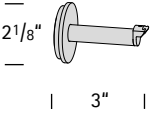
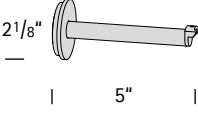
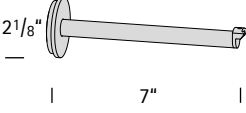
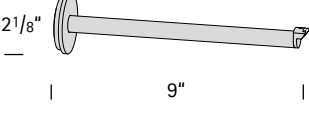
components	part	part-no.	color-no.	price
	traversing rod 1³/₁₆" dia. material: aluminium	31670	50 white	Cut to measure \$ / lin ft. 26.10
			56 black	
			62 brushed brass	
			70 chromium	
			72 brushed nickel	
			77 stainless steel	
			79 aluminium	
			80 antique bronzed	
				
56 black	47.30			
62 brushed brass	54.40			
64 copper	54.40			
70 chromium	66.20			
72 brushed nickel	54.40			
77 stainless steel	54.40			
79 aluminium	47.30			
80 antique bronzed	54.40			
	finial Poetry	31601	62 brushed brass	123.90
			64 copper	177.90
			72 brushed nickel	123.90
			80 antique bronzed	123.90
	finial Fantasy	31602	62 brushed brass	123.90
			64 copper	177.90
			72 brushed nickel	123.90
			80 antique bronzed	123.90
	bracket flat 3"	31631	50 white	165.40
			56 black	165.40
			62 brushed brass	190.20
			70 chromium	231.60
			72 brushed nickel	190.20
			77 stainless steel	190.20
			79 aluminium	165.40
			80 antique bronzed	190.20
	bracket flat 5"	31632	50 white	174.40
			56 black	174.40
			62 brushed brass	200.60
			70 chromium	244.30
			72 brushed nickel	200.60
			77 stainless steel	200.60
			79 aluminium	174.40
			80 antique bronzed	200.60
	bracket flat 7"	31633	50 white	183.40
			56 black	183.40
			62 brushed brass	211.00
			70 chromium	256.80
			72 brushed nickel	211.00
			77 stainless steel	211.00
			79 aluminium	183.40
			80 antique bronzed	211.00

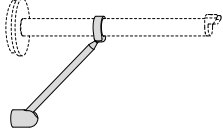
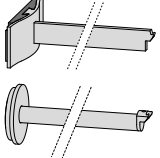

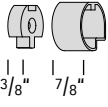
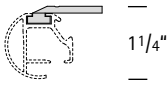
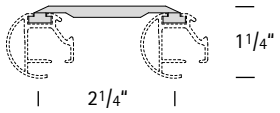
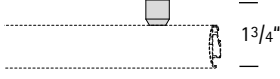
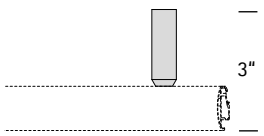

traversing round 1³/₁₆" dia.

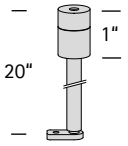
components	part	part-no.	color-no.	price
 2 ¹ / ₈ " 3"	bracket 3"	31611	50 white	107.40
			56 black	107.40
			62 brushed brass	124.50
			70 chromium	151.10
			72 brushed nickel	124.50
			77 stainless steel	124.50
			79 aluminium	107.40
			80 antique bronzed	124.50
 2 ¹ / ₈ " 5"	bracket 5"	31612	50 white	107.40
			56 black	107.40
			62 brushed brass	124.50
			70 chromium	151.10
			72 brushed nickel	124.50
			77 stainless steel	124.50
			79 aluminium	107.40
			80 antique bronzed	124.50
 2 ¹ / ₈ " 7"	bracket 7"	31613	50 white	120.90
			56 black	120.90
			62 brushed brass	140.30
			70 chromium	166.90
			72 brushed nickel	140.30
			77 stainless steel	140.30
			79 aluminium	120.90
			80 antique bronzed	140.30
 2 ¹ / ₈ " 9"	bracket 9"	31614	50 white	120.90
			56 black	120.90
			62 brushed brass	140.30
			70 chromium	166.90
			72 brushed nickel	140.30
			77 stainless steel	140.30
			79 aluminium	120.90
			80 antique bronzed	140.30
 1"	extension piece 1"	31619	50 white	19.00
			56 black	19.00
			62 brushed brass	22.70
			70 chromium	27.20
			72 brushed nickel	22.70
			77 stainless steel	22.70
			79 aluminium	19.00
			80 antique bronzed	22.70
	bracket support	20617	50 white	82.20
			56 black	82.20
			62 brushed brass	100.20
			70 chromium	110.40
			72 brushed nickel	100.20
			77 stainless steel	100.20
			79 aluminium	82.20
			80 antique bronzed	100.20
	shorten bracket	S		
	service			
	for brackets 31631-31633			surcharge 64.00
	for brackets 31611-31614		surcharge 43.00	
	e.g. 31612-77-S-4"			



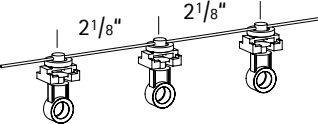
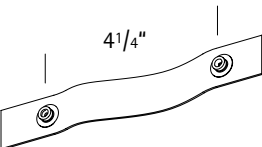
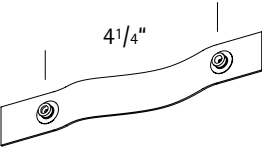

traversing round 1³/₁₆" dia.

components	part	part-no.	color-no.	price	
	wall socket can be used at both ends	31605	50	white	63.00
			56	black	63.00
			62	brushed brass	73.20
			70	chromium	87.80
			72	brushed nickel	73.20
			77	stainless steel	73.20
			79	aluminium	63.00
			80	antique bronzed	73.20
	ceiling bracket close to ceiling shadow gap 1/8"	31514	50	white	21.40
			79	aluminium	21.40
	ceiling bracket close to ceiling for double rod shadow gap 1/8"	30524	50	white	33.30
			79	aluminium	33.30
	ceiling bracket 3/4"	21614	50	white	50.70
			56	black	50.70
			62	brushed brass	57.40
			70	chromium	69.80
			72	brushed nickel	57.40
			77	stainless steel	57.40
			79	aluminium	50.70
			80	antique bronzed	57.40
	ceiling bracket 2"	21616	50	white	60.50
			56	black	60.50
			62	brushed brass	69.80
			70	chromium	83.30
			72	brushed nickel	69.80
			77	stainless steel	69.80
			79	aluminium	60.50
			80	antique bronzed	69.80
	extension piece 3/4" for ceiling bracket 21614, 21616	21617	50	white	24.80
			56	black	24.80
			62	brushed brass	28.60
			70	chromium	36.00
			72	brushed nickel	28.60
			77	stainless steel	28.60
			79	aluminium	24.80
			80	antique bronzed	28.60
	ceiling bracket 20" can be shortened	21615	50	white	93.40
			56	black	93.40
			62	brushed brass	107.40
			70	chromium	119.40
			72	brushed nickel	107.40
			77	stainless steel	107.40
			79	aluminium	93.40
			80	antique bronzed	107.40

traversing round 1³/₁₆" dia.

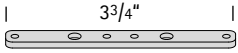
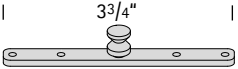
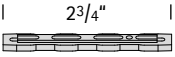
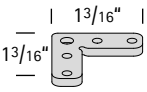
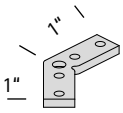
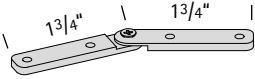
components	part	part-no.	color-no.	price
	roller with eyelet	30082	50 white	0.80
	curtain hook	30080	50 white	0.20
	runner for batons can be retrofitted	30078	50 white	3.60
	stop clamp	30089	50 white	1.80
	carriers with cord spacing between carriers 2 ¹ / ₈ " with easy snap for convenient installation	40 pcs 29085/40 60 pcs 29085/60 80 pcs 29085/80 100 pcs 29085/100 120 pcs 29085/120	50 white 50 white 50 white 50 white 50 white	52.00 78.00 104.00 130.00 156.00
	ripplefold tape spacing between buttons 4 ¹ / ₄ " 100 % fullness pool 100 yards	29012	50 white 11 transparent	413.60 413.60
	ripplefold tape spacing between buttons 4 ¹ / ₄ " 100 % fullness cut to measure	29010	50 white 11 transparent	per lin. ft. 1.70 per lin. ft. 1.70

traversing round 1³/₁₆" dia.

components	part	part-no.	color-no.	price
	connector	30579	99	16.90
	connector for ceiling brackets 21614, 21616	30577	99	16.90
	connector for brackets 31514, 30524 (plastic)	21719	99	13.50
	corner connector 90° mitre cut \$ 43.00	30550	99	25.90
	corner connector 135° mitre cut \$ 43.00	30551	99	30.40
	corner connector flexible mitre cut \$ 43.00	30552	99	59.70
	traversing rod and accessories for double rod		see page 519	
	batons		see page 275	
	accessories		see page 276	



plenum genuine beech/aluminium



plenum wengé/aluminium

finishes available

28 wengé

40 genuine beech

43 genuine oak

46 genuine maple

plenum 28/79 wengé/aluminium



scale 1:1



traversing round 1 3/16" dia.

finishes available

- 28/79 wengé/aluminium
- 40/79 genuine beech/aluminium
- 43/79 genuine oak/aluminium
- 46/79 genuine maple/aluminium

single rod

□ color-no. 1
 ■ color-no. 2

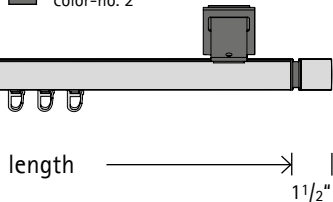

set-no. 03111
Plenum

length (ft.)	sliders	brackets	bracket 3"	bracket 5"
3	16	2	\$ 467	494
4	20	2	496	523
5	24	2	524	551
6	30	3	695	736
7	34	3	723	764
8	40	3	753	793
9	44	3	781	822
• 10	50	3	810	851
11	54	4	980	1034
12	60	4	1010	1064
13	64	4	1038	1092
14	68	4	1066	1120
15	74	4	1096	1150
16	78	4	1124	1178
17	84	5	1295	1363
18	88	5	1323	1391
reduction per wall socket			124	138

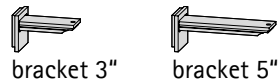

double rod

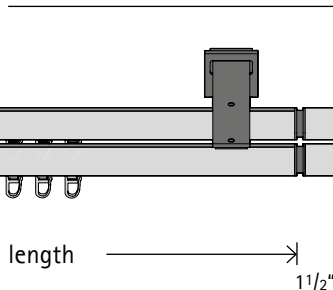

set-no. 03112
Plenum



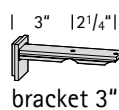

length (ft.)	sliders	brackets	bracket 3"
3	32	2	\$ 696
4	40	2	753
5	48	2	810
6	60	3	1032
7	68	3	1089
8	80	3	1148
9	88	3	1204
• 10	100	3	1263
11	108	4	1484
12	120	4	1542
13	128	4	1599
14	136	4	1656
15	148	4	1714
16	156	4	1771
17	168	5	1994
18	176	5	2051
reduction per wall socket			129

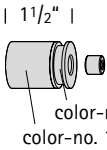
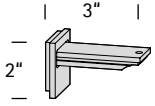
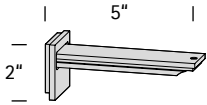
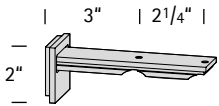
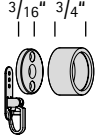

Notes

- polers in excess of 9ft. will be delivered in two sections

traversing round 1³/₁₆" dia.

components	part	set-no.	color-no.	price
	traversing rod 1³/₁₆" dia.	30320	28 wengé 40 genuine beech 43 genuine oak 46 genuine maple	Cut to measure \$/ lin ft. 26.80 26.80 26.80 26.80
	finial Plenum	30429	28/79 wengé/aluminium 40/79 genuine beech/aluminium 43/79 genuine oak/aluminium 46/79 genuine maple/aluminium	47.80 47.80 47.80 47.80
	bracket 3"	30411	79 aluminium	141.80
	bracket 5"	30412	79 aluminium	155.30
	double bracket 3"	30421	79 aluminium	164.40
	wall socket with anchor clip can be used at both ends	30705	79 aluminium	65.30
	slider with eyelet	30081	50 white	0.40
	curtain hook	30080	50 white	0.20
	stop clamp	30083	99	0.60

page 264



page 268



1³/₁₆"
dia.

ceiling

zenit 30 chromium



finishes available

70 chromium

77 stainless steel

79 aluminium



zenit 30 70 chromium



scale 1:1

traversing round 1³/₁₆" dia.



traversing round 1³/₁₆" dia.

finishes available

- A 79 aluminium
- B 77 stainless steel
- C 70 chromium

material: aluminium

single rod

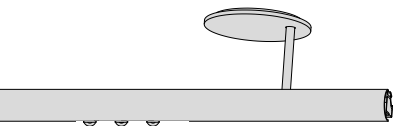

length →

set-no.

Zenit 30 03130

set without
finials
finials see
page 271

length rollers brackets

(ft.)

3	16	2	\$
4	20	2	
5	24	2	
6	30	3	
7	34	3	
8	40	3	
9	44	3	
• 10	50	3	
11	54	4	
12	60	4	
13	64	4	
14	68	4	
15	74	4	
16	78	4	
17	84	5	
18	88	5	

reduction per wall socket

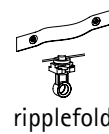
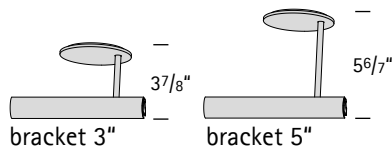

ripplefold

surcharge

bracket 3"			bracket 5"			
A	B	C	A	B	C	
397	453	548	464	531	636	61
426	486	594	493	564	682	58
455	520	640	523	597	728	54
637	728	889	738	844	1021	50
666	761	935	767	877	1067	87
697	796	982	798	912	1114	82
726	829	1028	828	945	1160	79
757	863	1075	858	980	1207	74
938	1070	1323	1072	1225	1499	107
968	1105	1370	1103	1260	1546	102
998	1138	1416	1133	1293	1592	99
1027	1171	1462	1162	1326	1637	136
1058	1206	1509	1193	1361	1685	131
1087	1239	1555	1222	1394	1730	128
1269	1447	1804	1438	1641	2024	123
1298	1480	1850	1467	1674	2070	148

Notes

- rods in excess of 9ft. will be delivered in two sections



accessories see page 276

corpus 30 black



50 white
(Novum, Corpus only)

56 black
(Corpus only)

70 chromium

77 stainless steel

79 aluminium

62 brushed brass
(Corpus only)

72 brushed nickel
(Novum, Corpus only)

80 antique bronzed
(Corpus only)

votum 30 77 stainless steel



novum 30 72 brushed nickel



corpus 30 80 antique bronzed



scale 1:1



traversing round 1³/₁₆" dia.

finishes available

material: aluminium

- A 50 white (Novum only)
79 aluminium
- B 72 brushed nickel (Novum only)
77 stainless steel
- C 70 chromium

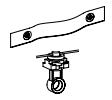

single rod

length rollers brackets



ripplefold

(ft.)				A	B	C	surcharge
3	16	2	\$	316	361	434	61
4	20	2		345	394	480	58
5	24	2		374	427	526	54
6	30	3		515	589	718	50
7	34	3		545	622	764	87
8	40	3		576	656	811	82
9	44	3		605	690	857	79
• 10	50	3		636	724	904	74
11	54	4		776	885	1095	107
12	60	4		806	919	1142	102
13	64	4		836	952	1188	99
14	68	4		865	985	1234	136
15	74	4		896	1020	1281	131
16	78	4		925	1053	1327	128
17	84	5		1067	1215	1519	123
18	88	5		1096	1248	1565	148



length →

set-no.

Votum 30 03131

set without
finials

finials see
page 271



single rod

length rollers brackets



(ft.)				A	B	C	
3	16	2	\$	379	433	524	
4	20	2		408	466	570	
5	24	2		437	500	616	
6	30	3		610	698	853	
7	34	3		639	731	899	
8	40	3		670	766	946	
9	44	3		699	799	992	
• 10	50	3		730	833	1039	
11	54	4		902	1030	1275	
12	60	4		932	1065	1322	
13	64	4		962	1098	1368	
14	68	4		991	1131	1414	
15	74	4		1022	1166	1461	
16	78	4		1051	1199	1507	
17	84	5		1224	1397	1744	
18	88	5		1253	1430	1790	

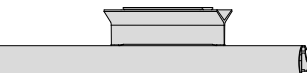

length →

set-no.

Novum 30 03132

set without
finials

finials see
page 271



Notes

- rods in excess of 9ft. will be delivered in two sections



accessories see page 276

traversing round 1³/₁₆" dia.

finishes available

material: aluminium

- A** 50 white
56 black
79 aluminium
- B** 62 brushed brass
72 brushed nickel
77 stainless steel
80 antique bronzed

- C** 70 chromium

single rod



length →

length rollers brackets

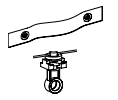
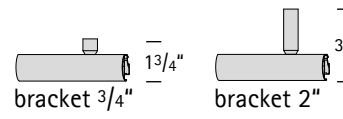

ripplefold

(ft.)	length	rollers	brackets		A	B	C	A	B	C	surcharge
3	16	2		\$	196	221	284	216	246	311	61
4	20	2			225	254	329	245	279	356	58
5	24	2			255	287	375	274	312	402	54
6	30	3			336	379	492	366	416	533	50
7	34	3			366	412	538	395	450	578	87
8	40	3			397	447	585	426	484	626	82
9	44	3			426	480	631	455	517	671	79
• 10	50	3			457	515	678	486	552	719	74
11	54	4			537	605	794	576	655	848	107
12	60	4			568	640	841	607	690	895	102
13	64	4			597	673	887	636	723	941	99
14	68	4			626	706	932	665	756	986	136
15	74	4			657	741	980	696	791	1034	131
16	78	4			686	774	1025	726	824	1079	128
17	84	5			768	866	1142	817	928	1210	123
18	88	5			797	899	1188	846	961	1256	148

set-no.

Corpus 30 03133

set without
finials
finials see below

rods in excess of 9ft. will be delivered in two sections

components

part

part-no.

color-no.

price

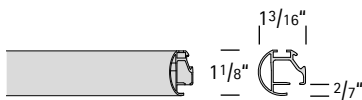

traversing rod 1³/₁₆" dia.
material: aluminium

31670

- 50 white
56 black
62 brushed brass
70 chromium
72 brushed nickel
77 stainless steel
79 aluminium
80 antique bronzed

Cut to measure
\$/ lin ft.

- 26.10
26.10
29.90
42.50
29.90
29.90
26.10
29.90

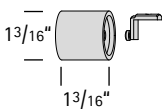

end cap
Sympathy

31629

- 50 white
56 black
62 brushed brass
64 copper
70 chromium
72 brushed nickel
77 stainless steel
79 aluminium
80 antique bronzed

- 47.30
47.30
54.40
54.40
66.20
54.40
54.40
47.30
54.40

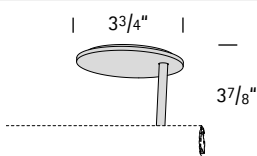





ceiling bracket
Zenit
3"
can be shortened

21815



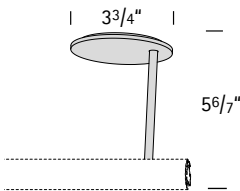
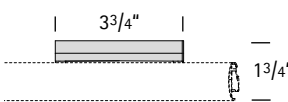
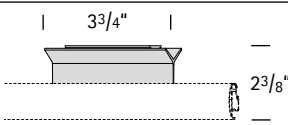

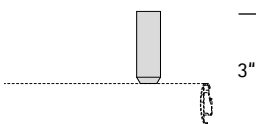
- 70 chromium
77 stainless steel
79 aluminium

- 202.20
173.60
150.90



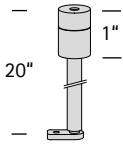
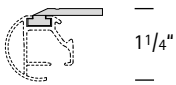
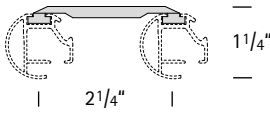
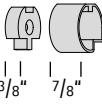

traversing round 1³/₁₆" dia.

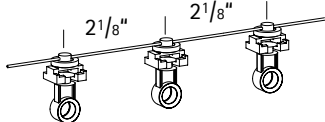
components	part	part-no.	color-no.	price
	ceiling bracket Zenit	21816	70 chromium	246.10
	5" can be shortened		77 stainless steel	212.30
	for longer suspension please inquire		79 aluminium	184.60
	ceiling bracket Votum	21714	70 chromium	145.20
			77 stainless steel	127.20
			79 aluminium	110.40
	ceiling bracket Novum	22815	50 white	141.90
			70 chromium	190.20
			72 brushed nickel	163.60
			77 stainless steel	163.60
			79 aluminium	141.90
	ceiling bracket Corpus	21614	50 white	50.70
	3/4"		56 black	50.70
			60 polished brass	57.40
			62 brushed brass	57.40
			70 chromium	69.80
			72 brushed nickel	57.40
			77 stainless steel	57.40
			79 aluminium	50.70
			80 antique bronzed	57.40
	ceiling bracket Corpus	21616	50 white	60.50
	2"		56 black	60.50
			60 polished brass	69.80
			62 brushed brass	69.80
			70 chromium	83.30
			72 brushed nickel	69.80
			77 stainless steel	69.80
			79 aluminium	60.50
			80 antique bronzed	69.80
	extension piece 3/4" for ceiling bracket 21614, 21616	21617	50 white	24.80
			56 black	24.80
			60 polished brass	28.60
			62 brushed brass	28.60
			70 chromium	36.00
			72 brushed nickel	28.60
			77 stainless steel	28.60
			79 aluminium	24.80
			80 antique bronzed	28.60

traversing round 1³/₁₆" dia.

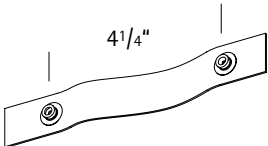
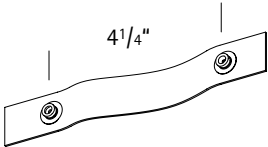
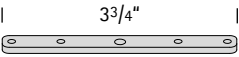
components	part	part-no.	color-no.	price		
	ceiling bracket 20" can be shortened	21615	50	white	93.40	
			56	black	93.40	
			62	brushed brass	107.40	
			70	chromium	119.40	
			72	brushed nickel	107.40	
			77	stainless steel	107.40	
			79	aluminium	93.40	
			80	antique bronzed	107.40	
	ceiling bracket close to ceiling shadow gap 1/8"	31514	50	white	21.40	
			79	aluminium	21.40	
	ceiling bracket close to ceiling for double rod shadow gap 1/8"	30524	50	white	33.30	
			79	aluminium	33.30	
	wall socket can be used at both ends	31605	50	white	63.00	
			56	black	63.00	
			62	brushed brass	73.20	
			70	chromium	87.80	
			72	brushed nickel	73.20	
			77	stainless steel	73.20	
			79	aluminium	63.00	
			80	antique bronzed	73.20	
	roller with eyelet	30082	50	white	0.80	
	curtain hook	30080	50	white	0.20	
	runner for batons can be retrofitted	30078	50	white	3.60	
	stop clamp	30089	50	white	1.80	
	carriers with cord spacing between carriers 2 ¹ / ₈ " with easy snap for convenient installation	40 pcs	29085/40	50	white	52.00
		60 pcs	29085/60	50	white	78.00
		80 pcs	29085/80	50	white	104.00
		100 pcs	29085/100	50	white	130.00
		120 pcs	29085/120	50	white	156.00

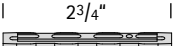
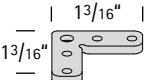
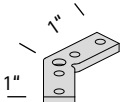
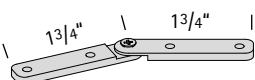
traversing round 1³/₁₆" dia.

components	part	part-no.	color-no.	price	
	ripplefold tape spacing between buttons 4 ¹ / ₄ " 100 % fullness spool 100 yards	29012	50	white	413.60
			11	transparent	413.60
	ripplefold tape spacing between buttons 4 ¹ / ₄ " 100 % fullness cut to measure	29010	50	white	per lin. ft. 1.70
			11	transparent	per lin. ft. 1.70
	connector for bracket Zenit	30578	99		16.90
	connector for ceiling bracket Corpus	30577	99		16.90
	connector for brackets Quantum, Votum, Novum and 31514, 30524 (plastic)	21719	99		13.50
	corner connector 90° mitre cut \$ 43.00	30550	99		25.90
	corner connector 135° mitre cut \$ 43.00	30551	99		30.40
	corner connector flexible mitre cut \$ 43.00	30552	99		59.70
	batons			see page 275	
	accessories			see page 276	

ACCESSORIES

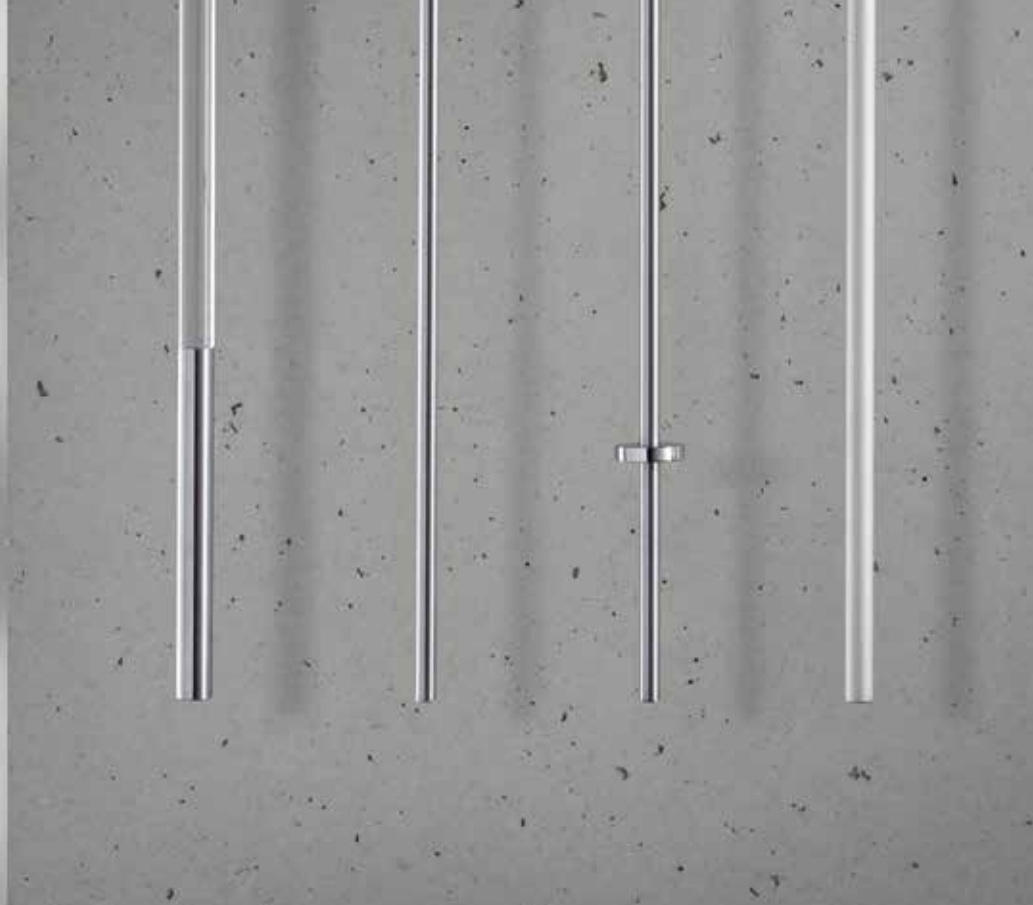

batons	part	part-no.	color-no.	price
<p>40"</p>	baton 40" material: acrylic glass with metal-grip	10510	90/50 acrylic glass/white	96.50
			90/70 acrylic glass/chromium	127.60
			90/77 acrylic glass/stainless steel	110.40
			90/79 acrylic glass/aluminium	96.50
<p>length</p>	baton 40" 50" 60" 80" 120"	11810	77 stainless steel	59.70
			79 aluminium	59.70
		11812	77 stainless steel	65.30
			79 aluminium	65.30
		11815	77 stainless steel	70.90
			79 aluminium	70.90
		11820	77 stainless steel	76.50
		11830	77 stainless steel	104.70
<p>length</p>	baton 40" 50" 60"	10813	77 stainless steel	82.20
			79 aluminium	82.20
		10812	77 stainless steel	87.80
			79 aluminium	87.80
		10815	77 stainless steel	93.40
			79 aluminium	93.40
<p>specify length</p>	shorten baton service e.g. 11815-77-S-55"	S	surcharge	43.00

ACCESSORIES



12796



12796

holdback

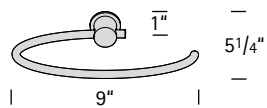

part

holdback
1" from wall
adjustable

part-no. color-no.

part-no.	color-no.	price
12796	50 white	132.90
	56 black	132.90
	60 polished brass	142.90
	62 brushed brass	171.50
	71 polished nickel	171.50
	72 brushed nickel	181.90
	77 stainless steel	151.90
	79 aluminium	132.90
	80 antique bronzed	181.90

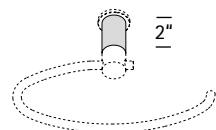

extension piece
2"
for holdback 12796

part-no.	color-no.	price
30697	50 white	39.40
	56 black	39.40
	60 polished brass	39.40
	62 brushed brass	47.30
	71 polished nickel	47.30
	72 brushed nickel	50.20
	77 stainless steel	47.30
	79 aluminium	39.40
	80 antique bronzed	50.20

ACCESSORIES



holdback

part

part-no. color-no.

price

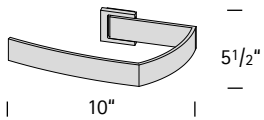

holdback

36796 77 stainless steel
79 aluminium

199.20
168.90

ACCESSORIES



21892



20687

components	part	part-no.	color-no.	price
	tieback	3"	21891 50 white	77.10
			51 anthracite	77.10
			56 black	77.10
		5"	21892 70 chromium	108.70
			77 stainless steel	90.00
79 aluminium	77.10			
	tieback	7"	21893 50 white	90.60
			51 anthracite	90.60
			56 black	90.60
		9"	21894 70 chromium	129.00
			77 stainless steel	105.80
			79 aluminium	90.60
	rosette	82291	50 white	31.50
			51 anthracite	31.50
			56 black	31.50
			70 chromium	43.90
			77 stainless steel	36.00
			79 aluminium	31.50
	tieback	3"	20686 60 polished brass	79.40
			62 brushed brass	95.40
			72 brushed nickel	101.20
		5"	20687 80 antique bronzed	101.20
	tieback	7"	20688 60 polished brass	92.90
			62 brushed brass	111.20
			72 brushed nickel	116.90
		9"	20689 80 antique bronzed	116.90

ACCESSORIES



26892

components	part	part-no.	color-no.	price		
	rosette	82094	60	polished brass	31.50	
			62	brushed brass	37.80	
			72	brushed nickel	40.10	
			80	antique bronzed	40.10	
	tieback	3"	26891	50	white	88.40
				51	anthracite	88.40
				56	black	88.40
		5"	26892	70	chromium	124.50
				77	stainless steel	103.50
				79	aluminium	88.40
	tieback	7"	26893	50	white	101.90
				51	anthracite	101.90
				56	black	101.90
		9"	26894	70	chromium	144.80
				77	stainless steel	119.30
				79	aluminium	101.90
	rosette	82691	50	white	42.80	
			51	anthracite	42.80	
			56	black	42.80	
			70	chromium	59.70	
			77	stainless steel	49.50	
			79	aluminium	42.80	

UNIVERSAL BRACKETS



components	part	part-no.	color-no.	price	
	universal bracket 3" incl. 1 screw part. no. 23716 2/5" adjustable in height	23711	50	white	65.30
			77	stainless steel	75.20
			79	aluminium	65.30
	universal bracket 4 3/4" incl. 2 screws part no. 23716 2/5" adjustable in height	23712	50	white	76.50
			77	stainless steel	88.10
			79	aluminium	76.50
	universal bracket 6 1/4" incl. 2 screws part no. 23716 2/5" adjustable in height	23713	50	white	87.80
			77	stainless steel	101.00
			79	aluminium	87.80
	bracket bolt	23716	99		2.70

price list 2018

traversing
round

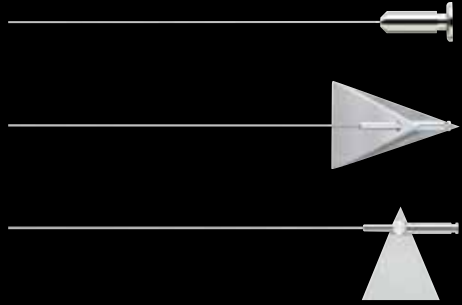

stainless steel

wire

vario aluminium

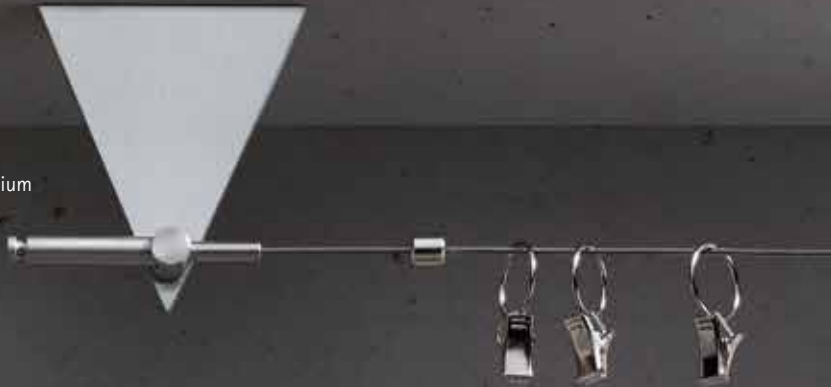

selecta polished nickel

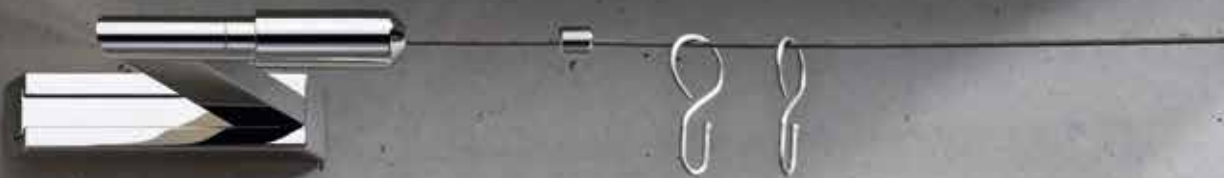

techno stainless steel



finishes available



77 stainless steel



79 aluminium



60 polished brass



71 polished nickel



72 brushed nickel

— vario, techno —

— selecta —

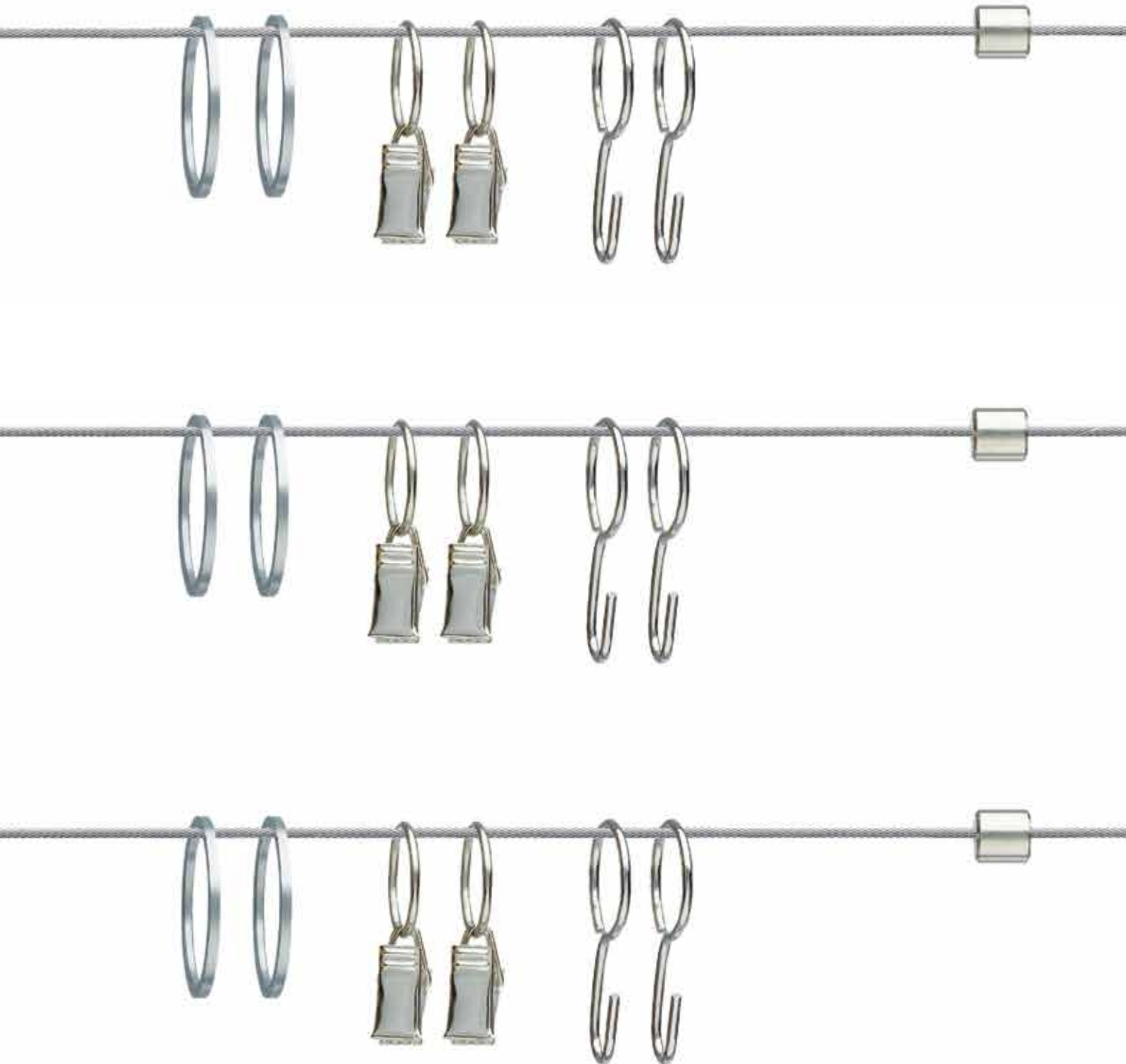

set up variations Vario



on the wall

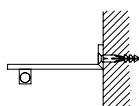

to the ceiling

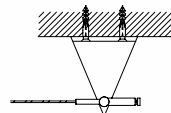

for sloping ceilings

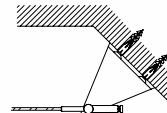

wall to wall

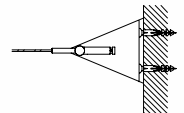

selecta 71 polished nickel



techno 77 stainless steel



vario 79 aluminium

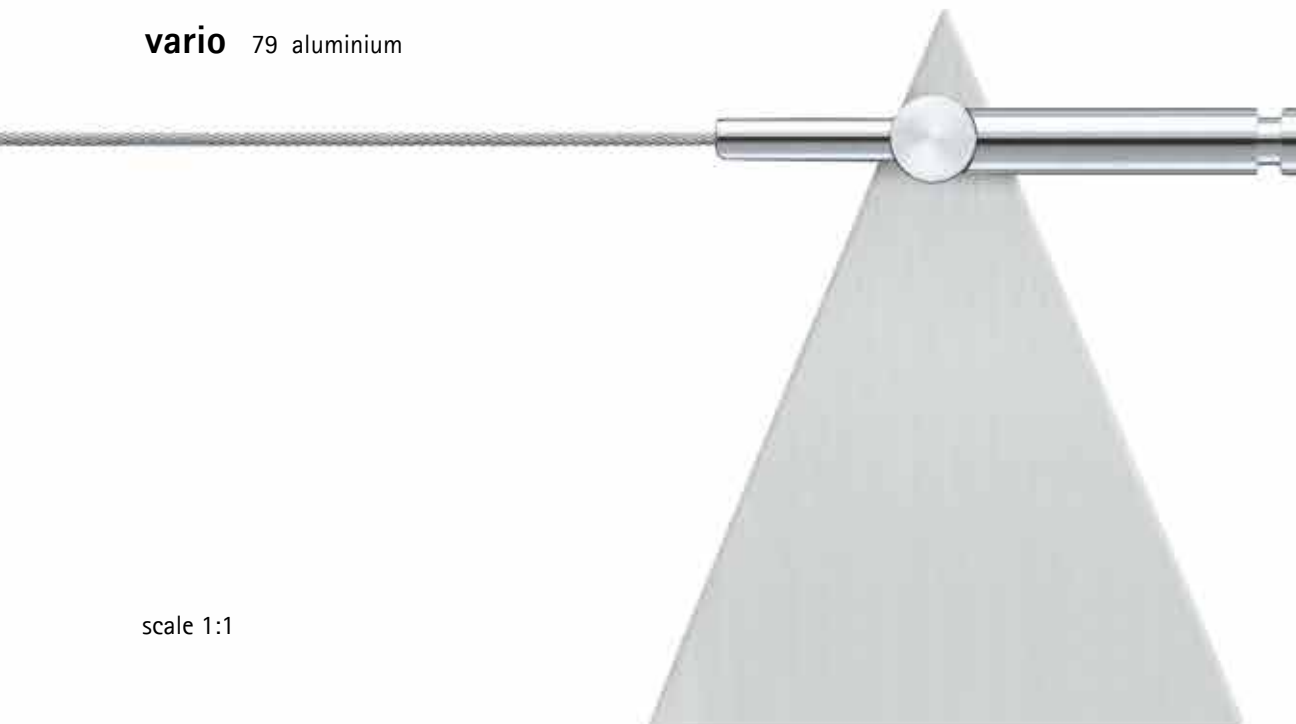

scale 1:1

wire system

finishes available

- 77 stainless steel
- 79 aluminium

material: aluminium

Vario

length

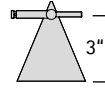

(ft.)

16¹/₂
33

\$ 294
327

bracket can be used as wall socket

set.-no. 01413

Techno

length

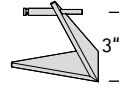

(ft.)

16¹/₂
33

\$ 402
435
54

reduction per wall socket

set.-no. 01412

finishes available

- A 60 polished brass
- B 71 polished nickel
- C 72 brushed nickel

material: brass

Selecta wall to wall

length



(ft.)

16¹/₂
33

	A	B	C
\$	226	262	275
	260	296	308

set.-no. 01401

Selecta bracket 3"

length

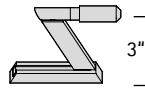

(ft.)

16¹/₂
33

	A	B	C
\$	615	729	770
	649	763	804
	195	234	248

reduction per wall socket

set.-no. 01406

Notes



intermediate bracket





see page 296





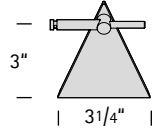
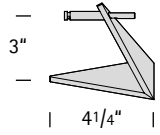
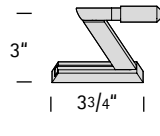
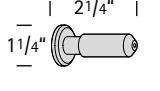
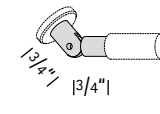

rings and hooks

see page 295

wire system

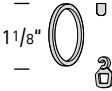
components	part	part-no.	color-no.	price
	wire 1/16" dia.	16 1/2 ft. 55405	77 stainless steel	37.20
		33 ft. 55410	77 stainless steel	70.90
	bracket 3" Vario use as wall socket for Techno material: aluminium	14932	77 stainless steel 79 aluminium	123.90 123.90
	bracket 3" Techno material: aluminium	14931	77 stainless steel 79 aluminium	177.90 177.90
	bracket 3" Selecta	14911	60 polished brass 71 polished nickel 72 brushed nickel	284.80 341.70 362.20
	wall socket Selecta	14605	60 polished brass 71 polished nickel 72 brushed nickel	90.10 108.10 114.40
	swivel joint for wall sockets	14616	60 polished brass 71 polished nickel 72 brushed nickel	78.80 94.50 100.20
	stop clamp	14496	71 polished nickel	4.30
	wire hook	14406	77 stainless steel	1.20
	wire hook	14407	71 polished nickel	1.60
	ring 1 1/8" x 1/16"	12609	77 stainless steel	3.90

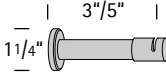
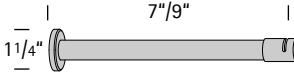
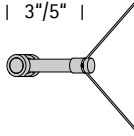
wire system

components	part	part-no.	color-no.	price
	ring 1 1/8" x 1/16" with eyelet clip	12608	77 stainless steel	4.10
	eyelet clip	10923	50 white	0.20
	intermediate bracket can be retrofitted	3"	14621 60 polished brass	79.90
			71 polished nickel	96.10
			72 brushed nickel	101.80
	intermediate bracket can be retrofitted	5"	14622	
		7"	14623 60 polished brass	93.40
			71 polished nickel	111.90
		72 brushed nickel	117.50	
	inside corner bracket for any angle	3"	14681 60 polished brass	184.60
			71 polished nickel	221.60
			72 brushed nickel	235.10
	extension piece 1" for inside corner bracket and intermediate bracket	30719	60 polished brass	19.00
			71 polished nickel	22.70
			72 brushed nickel	24.10

selecting an inside corner bracket

bracket length = projection from the wall	angle inside corner	assembly inside corner bracket
3"	90°	i. c. bracket 14681 with extension piece 30719
	105°	i. c. bracket 14681 (shorten 1/2") with extension piece 30719
	120°	i. c. bracket 14681 (shorten 3/4") with extension piece 30719
	135°	i. c. bracket 14681
	150°	i. c. bracket 14681 (shorten 1/4")
4"	90°	i. c. bracket 14682 (shorten 9/16") with extension piece 30719
	105°	i. c. bracket 14682 (shorten 1/4")
	120°	i. c. bracket 14682 (shorten 11/16")
	135°	i. c. bracket 14681 with extension piece 30719
	150°	i. c. bracket 14681 (shorten 11/4")

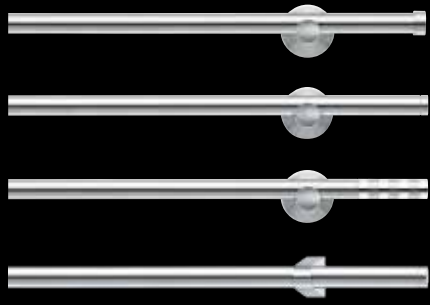

stainless steel

5/8"
dia.



synthese stainless steel/polished stainless steel



barett stainless steel



torero stainless steel



barett 77 stainless steel



torero 77 stainless steel



synthese 77 stainless steel/polished stainless steel



torero-poco 77 stainless steel



scale 1:1

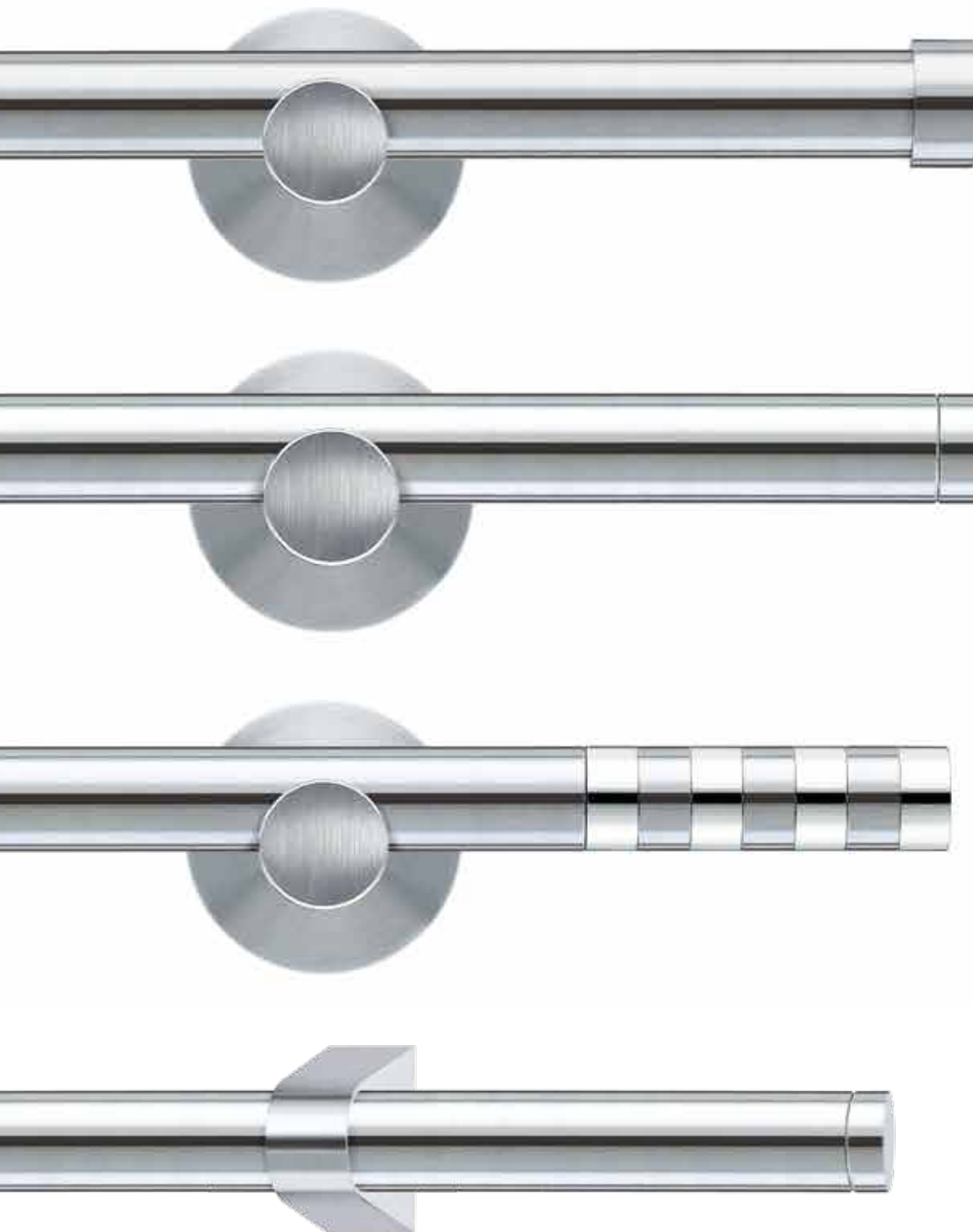

finial synthese



40 genuine beech



66 polished stainless steel

stainless steel 5/8" dia.

finish available

77 stainless steel

single rod

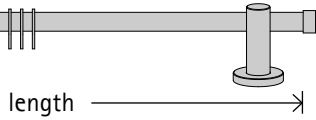

		set-no.
	Barett	01692
	Torero	01696

length (ft.)	*rings	brackets		bracket 2"	bracket 3"	bracket 5"	integral	brackets surcharge
3	14	2	\$	367	384	399	2	280
4	18	2		404	421	437	2	289
5	22	3		532	558	581	2	207
6	26	3		570	595	618	2	216
7	30	3		607	633	655	2	225
8	34	3		644	670	693	2	234
9	38	4		772	807	837	3	370
• 10	42	4		809	844	874	3	379
11	48	4		857	892	922	3	388
12	52	4		895	929	959	3	397
13	56	4		932	966	997	3	406
14	60	5		1060	1103	1141	3	325
15	64	5		1097	1140	1178	3	334
16	68	5		1135	1178	1216	3	343
17	72	5		1172	1215	1253	3	352
18	76	5		1209	1252	1290	3	361
reduction per wall socket				70	79	87		

double rod

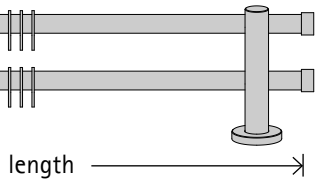

		set-no.
	Barett	01693
	Torero	01697

length (ft.)	*rings	brackets		2" 2" bracket 2"	3" 2" bracket 3"	integral	brackets surcharge
3	28	2	\$	608	624	2	532
4	36	2		683	699	2	550
5	44	3		876	900	2	449
6	52	3		951	975	2	467
7	60	3		1026	1050	2	485
8	68	3		1100	1124	2	503
9	76	4		1293	1325	3	761
• 10	84	4		1368	1400	3	779
11	96	4		1464	1496	3	797
12	104	4		1538	1570	3	815
13	112	4		1613	1645	3	833
14	120	5		1806	1846	3	733
15	128	5		1881	1921	3	751
16	136	5		1956	1996	3	769
17	144	5		2030	2070	3	787
18	152	5		2105	2145	3	805
reduction per wall socket				78	86		
surcharge distance between rods 3"				11	11 per bracket		

Notes

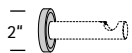

larger base plate + \$ 14.00 per bracket

* with plastic inserts



• tubes in excess of 9ft. will be delivered in two sections see page 341 accessories

stainless steel 5/8" dia.

finishes available

77/40 stainless steel/genuine beech

77/66 stainless steel/polished stainless steel

single rod

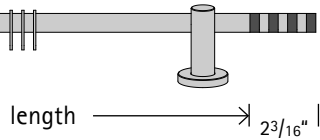

length → 2³/₁₆" |
set-no.
Synthese 01620

length (ft.)	*rings	brackets	bracket 2"	bracket 3"	bracket 5"	integral brackets surcharge
3	14	2	\$ 518	535	550	2 280
4	18	2	555	572	587	2 289
5	22	3	683	709	732	2 207
6	26	3	720	746	769	2 216
7	30	3	758	783	806	2 225
8	34	3	795	821	844	2 234
9	38	4	923	957	988	3 370
• 10	42	4	960	995	1025	3 379
11	48	4	1008	1043	1073	3 388
12	52	4	1045	1080	1110	3 397
13	56	4	1083	1117	1148	3 406
14	60	5	1211	1254	1292	3 325
15	64	5	1248	1291	1329	3 334
16	68	5	1285	1328	1366	3 343
17	72	5	1323	1366	1404	3 352
18	76	5	1360	1403	1441	3 361
reduction per wall socket			146	154	162	

double rod

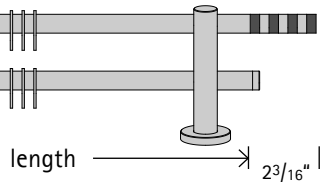

length → 2³/₁₆" |
set-no.
Synthese 01621

length (ft.)	*rings	brackets	bracket 2"	bracket 3"	integral brackets surcharge
3	28	2	\$ 759	775	2 532
4	36	2	834	850	2 550
5	44	3	1027	1051	2 449
6	52	3	1102	1126	2 467
7	60	3	1176	1200	2 485
8	68	3	1251	1275	2 503
9	76	4	1444	1476	3 761
• 10	84	4	1519	1551	3 779
11	96	4	1615	1647	3 797
12	104	4	1689	1721	3 815
13	112	4	1764	1796	3 833
14	120	5	1957	1997	3 733
15	128	5	2032	2072	3 751
16	136	5	2106	2146	3 769
17	144	5	2181	2221	3 787
18	152	5	2256	2296	3 805
reduction per wall socket			154	162	
surcharge distance between rods 3"			11	11 per bracket	

Notes

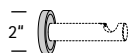

larger base plate + \$ 14.00 per bracket

* with plastic inserts

• tubes in excess of 9ft. will be delivered in two sections accessories see page 341



components see page 302

stainless steel 5/8" dia.

finish available

77 stainless steel

material bracket:

aluminium

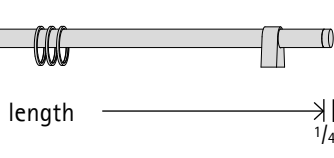
single rod	length (ft.)	*rings	brackets	bracket 1"	bracket 2"	integral		
						brackets surcharge		
 <p>length $\pm 1/4"$</p>	3	14	2	\$ 303	320	2	252	
	4	18	2	341	357	2	261	
	5	22	3	437	462	2	211	
	6	26	3	474	499	2	220	
	7	30	3	511	537	2	229	
	8	34	3	549	574	2	238	
	9	38	4	645	679	3	360	
	• 10	42	4	682	716	3	369	
	11	48	4	730	764	3	378	
	12	52	4	767	801	3	387	
	13	56	4	805	838	3	396	
	set-no.							
	▣ Torero-Poco 01690	14	60	5	901	943	3	346
		15	64	5	938	980	3	355
		16	68	5	976	1018	3	364
		17	72	5	1013	1055	3	373
		18	76	5	1050	1092	3	382
		reduction per wall socket			39	47		

Notes





* with plastic inserts

accessories

see page 341

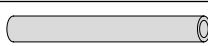

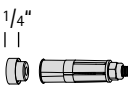
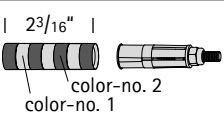

• tubes in excess of 9ft. will be delivered in two sections

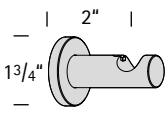
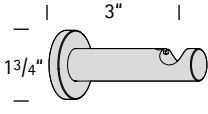
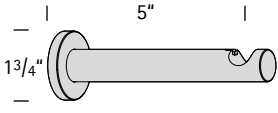
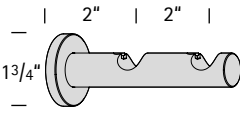
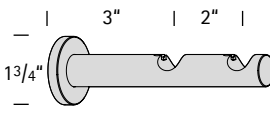
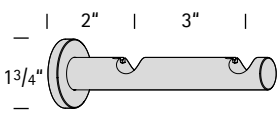
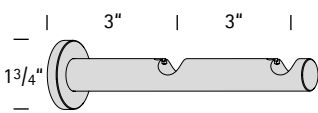
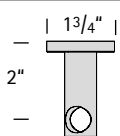
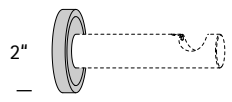
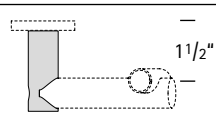
components	part	part-no.	color-no.	price
	stainless steel tube 5/8" dia. grind finish	16610	77 stainless steel	Cut to measure \$/lin. ft. 16.10
	end cap Barett	16629	77 stainless steel	31.50
	end cap Torero	16929	77 stainless steel	31.50
	finial Synthese	16703	77/40 stainless steel/genuine beech 77/66 stainless steel/pol. stainless steel	106.90 106.90

stainless steel 5/8" dia.

components	part	part-no.	color-no.	price
	bracket 2"	16611	77 stainless steel	90.70
	bracket 3"	16612	77 stainless steel	99.30
	bracket 5"	16613	77 stainless steel	106.90
	double bracket 2"	16621	77 stainless steel	118.70
	double bracket 3"	16622	77 stainless steel	126.70
	double bracket 2" 3" between rods	16623	77 stainless steel	129.70
	double bracket 3" 3" between rods	16624	77 stainless steel	137.70
	ceiling bracket 2"	16614	77 stainless steel	90.70
	larger base plate for all brackets except Poco e.g. 16612X	X	77 stainless steel	surcharge 14.00
	ceiling converter for ceiling mounts for brackets single and double rod except Poco	16618	77 stainless steel	56.30

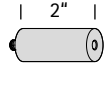
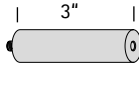
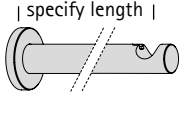
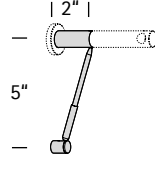
stainless steel 5/8" dia.

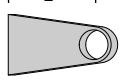
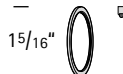
components	part	part-no.	color-no.	price
	extension piece 3/16" for all brackets and ceiling converter except Poco	12718	77 stainless steel	15.30
	extension piece 3/4" for all brackets and ceiling converter except Poco	12618	77 stainless steel	26.80
	extension piece 2" for all brackets and ceiling converter except Poco	12619	77 stainless steel	33.50
	extension piece 3" for all brackets and ceiling converter except Poco	12819	77 stainless steel	41.70
 specify length	shorten bracket service z.B. 16613-77-S-4" not for bracket poco	S		surcharge 43.00
	bracket support incl. 2" bracket extension for all brackets except Poco	12617	77 stainless steel	185.70
	bracket Poco 1" material: aluminium can also be used as ceiling bracket	16615	77 stainless steel	58.90
	bracket Poco 2" material: aluminium can also be used as ceiling bracket	16616	77 stainless steel	67.30
	ring 15/16" x 1/16" with plastic insert	14679	77 stainless steel	5.10

stainless steel 5/8" dia.

components	part	part-no.	color-no.	price	
	ring 1 5/16" x 1/16" with eyelet clip with plastic insert	14678	77	stainless steel	5.30
	eyelet clip	10923	50	white	0.20
	wall socket with anchor clip can be used at both ends	16705	77	stainless steel	51.80
	elbow 90° smooth	16650	77	stainless steel	83.30
	swivel joint	16651	77	stainless steel	118.20
	wall socket for sloping ceilings one side only	16652	77	stainless steel	142.50
	tube connector	16659	99		16.90
	mitre connector for any angle mitre cut \$ 43.00	16653	99		87.80
	accessories			see page 341	

page 308

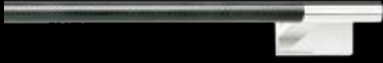

page 314

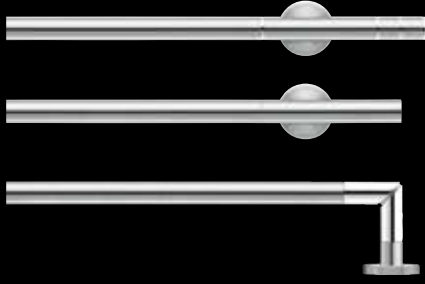

page 324

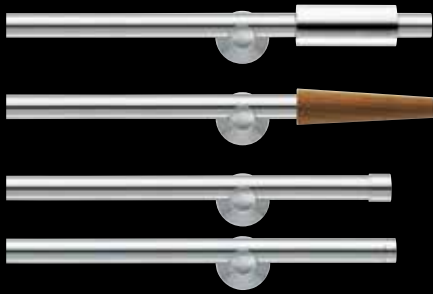

3/4"
dia.

outlook .4 carbon fiber/polished nickel



finishes available

16 carbon fiber

71 polished nickel

77 stainless steel



outlook .4 16/71 carbon fiber/polished nickel



scale 1:1

stainless steel 3/4" dia.



brackets, rings, finials



71 polished nickel



77 stainless steel

stainless steel 3/4" dia.

finishes available

- A 77 stainless steel
- B 71 polished nickel
- C 16/77 carbon fiber/stainless steel
- D 16/71 carbon fiber/polished nickel

single rod

- color no. 1
- color no. 2

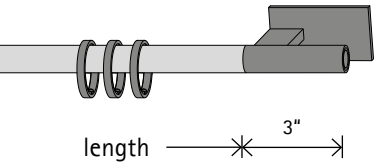

length ——— * 3" ———>

set no.
outlook .4 00041



length (ft.)	*rings	brackets		bracket 3"				bracket 4 3/4"				integral	
				A	B	C	D	A	B	C	D	brackets	surcharge
3	14	2	\$	545	620	677	727	590	670	722	776	2	278
4	18	2		594	681	770	823	639	731	815	873	2	288
• 5	22	3		812	928	1032	1105	880	1005	1100	1182	2	129
6	26	3		861	989	1125	1201	929	1065	1193	1278	2	139
7	30	3		910	1049	1218	1297	978	1126	1286	1374	2	149
8	34	3		959	1110	1311	1393	1027	1187	1379	1470	2	159
• 9	38	4		1177	1357	1573	1675	1267	1461	1663	1779	2	0
10	42	4		1226	1417	1666	1771	1316	1521	1756	1875	3	303
11	48	4		1291	1495	1775	1885	1381	1599	1865	1989	3	313
12	52	4		1340	1556	1868	1981	1430	1660	1958	2085	3	323
13	56	4		1389	1617	1961	2077	1479	1721	2051	2181	3	333
• 14	60	5		1607	1864	2223	2359	1719	1995	2335	2490	3	174
15	64	5		1656	1924	2316	2455	1768	2055	2428	2586	3	184
16	68	5		1705	1985	2409	2552	1817	2116	2521	2683	3	194
17	72	5		1754	2046	2502	2648	1866	2177	2614	2779	3	204
18	76	5		1803	2107	2595	2744	1915	2238	2707	2875	3	214
reduction per wall socket				135	144	135	144	158	169	158	169		

Notes

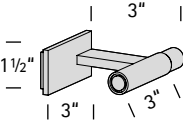
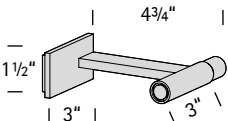
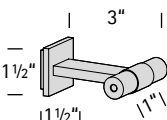
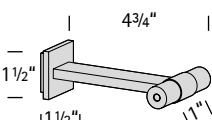
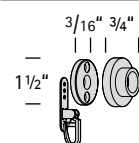
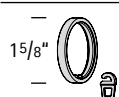

- accessories see page 341
- tubes cut at intermediate bracket
- * with plastic inserts

stainless steel 3/4" dia.

components	part	part-no.	color-no.	price	
	stainless steel tube 3/4" dia.	21610	77	stainless steel Cut to measure \$/ lin. ft. 17.80	
	brass tube 3/4" dia.	21610	71	polished nickel 26.40	
	carbon fiber tube 3/4" dia.	21610	16	carbon fiber 61.80	
	bracket 3"	left	20971	71 77	polished nickel stainless steel 210.40
		right	20972		191.40
	bracket 4 3/4"	left	20973	71 77	polished nickel stainless steel 235.30
		right	20974		213.90
	intermediate bracket 3"	20975	71 77	polished nickel stainless steel 185.70	
				168.90	
	intermediate bracket 4 3/4"	20977	71 77	polished nickel stainless steel 212.80	
				191.40	
	wall socket with anchor clip can be used at both ends	21905	71 77	polished nickel stainless steel 66.20	
				56.30	
	ring 1 5/8" x 3/16" with eyelet clip with plastic insert	20958	71 77	polished nickel stainless steel 8.60	
				7.80	
	eyelet clip	11921	50	white 0.20	



single stainless steel/polished stainless steel



double stainless steel/polished stainless steel



return 20 stainless steel



holdback stainless steel p. 342

double 77/66 stainless steel/polished stainless steel



single 77 stainless steel



return 20 77/66 stainless steel/polished stainless steel



scale 1:1





stainless steel 3/4" dia.



finishes available

- 77 stainless steel
- 77/66 stainless steel/pol. stainless steel

rings available

-  1 ring with plastic insert
-  2 ring wide with plastic insert

single rod

-  color no. 1
-  color no. 2

brackets sideways adjustable

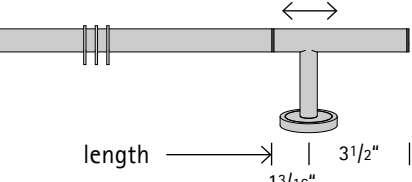

length → | 1 3/16" | 3 1/2" |

set-no.

 Single 02042

length (ft.)	rings	brackets	bracket 3"		bracket 5"		integral	
			1	2	1	2	brackets	surcharge
3	14	2	\$ 581	605	599	623	2	278
4	18	2	620	651	638	669	2	288
▲ 5	22	3	807	844	835	872	2	150
6	26	3	846	890	874	918	2	160
7	30	3	885	936	913	964	2	170
8	34	3	924	982	952	1009	2	180
▲ 9	38	4	1111	1175	1148	1212	2	42
10	42	4	1150	1221	1187	1258	3	324
11	48	4	1199	1281	1236	1318	3	334
12	52	4	1238	1327	1275	1364	3	344
13	56	4	1277	1373	1314	1409	3	354
▲ 14	60	5	1464	1566	1510	1612	3	216
15	64	5	1503	1612	1549	1658	3	226
16	68	5	1542	1658	1588	1704	3	236
17	72	5	1581	1704	1627	1750	3	246
18	76	5	1620	1750	1666	1796	3	256
reduction per wall socket			170	170	180	180		

▲ tube cut at intermediate bracket.
Off-center cuts on request

Notes



accessories

see page 341

stainless steel 3/4" dia.

finish available



77/66 stainless steel/pol. stainless steel

rings available

 1 ring with plastic insert

 2 ring wide with plastic insert

single rod

 color no. 1
 color no. 2

brackets sideways adjustable

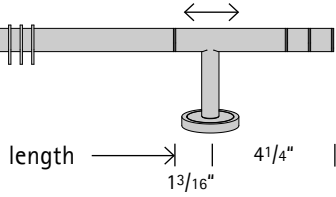

 **Double** 02044

set-no.

length (ft.)	rings	brackets	bracket 3"		bracket 5"		integral	
			1	2	1	2	brackets	surcharge
3	14	2	\$ 653	677	671	695	2	278
4	18	2	692	723	710	741	2	288
▲ 5	22	3	879	916	907	944	2	150
6	26	3	918	962	946	990	2	160
7	30	3	957	1008	985	1036	2	170
8	34	3	996	1054	1024	1081	2	180
▲ 9	38	4	1183	1247	1220	1284	2	42
10	42	4	1222	1293	1259	1330	3	324
11	48	4	1271	1353	1308	1390	3	334
12	52	4	1310	1399	1347	1436	3	344
13	56	4	1349	1445	1386	1481	3	354
▲ 14	60	5	1536	1638	1582	1684	3	216
15	64	5	1575	1684	1621	1730	3	226
16	68	5	1614	1730	1660	1776	3	236
17	72	5	1653	1776	1699	1822	3	246
18	76	5	1692	1822	1738	1868	3	256
reduction per wall socket			206	206	216	216		

▲ tube cut at intermediate bracket.
Off-center cuts on request

Notes



accessories



see page 341

stainless steel 3/4" dia.



finishes available

- 77 stainless steel
- 77/66 stainless steel/pol. stainless steel

rings available

-  1 ring with plastic insert
-  2 ring wide with plastic insert

single rod

-  color no. 1
-  color no. 2

brackets sideways adjustable

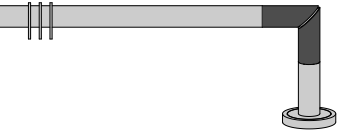

length → | 3/4" |



set-no.
Return 20 02046

length (ft.)	rings	brackets	bracket 3 3/4"		bracket 5"		integral	
			1	2	1	2	brackets	surcharge
3	14	2	\$ 589	613	605	629	2	278
4	18	2	628	658	644	675	2	288
▲ 5	22	3	828	865	852	890	2	137
6	26	3	867	911	891	935	2	147
7	30	3	906	957	930	981	2	157
8	34	3	945	1002	969	1027	2	167
▲ 9	38	4	1144	1209	1177	1242	2	17
10	42	4	1183	1255	1216	1287	3	311
11	48	4	1233	1314	1266	1347	3	321
12	52	4	1272	1360	1305	1393	3	331
13	56	4	1311	1406	1344	1439	3	341
▲ 14	60	5	1511	1613	1552	1654	3	191
15	64	5	1550	1658	1591	1699	3	201
16	68	5	1589	1704	1630	1745	3	211
17	72	5	1628	1750	1669	1791	3	221
18	76	5	1667	1796	1708	1837	3	231
reduction per wall socket			174	174	183	183		

▲ tube cut at intermediate bracket.
Off-center cuts on request



Notes



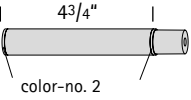
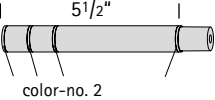
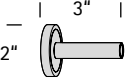
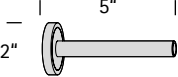
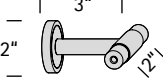
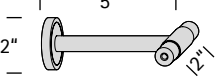

accessories

see page 341

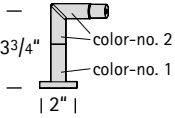
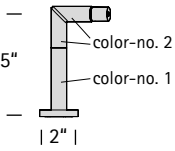

stainless steel 3/4" dia.

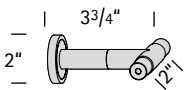
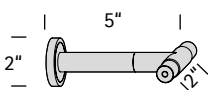
components	part	part-no.	color-no.	price
	stainless steel tube 3/4" dia. grind finish	20610	77 stainless steel	Cut to measure \$/lin. ft. 17.80
	finial Single	20763	77 stainless steel 77/66 stainless steel/pol. stainless steel	139.60 139.60
	finial Double	20764	77/66 stainless steel/pol. stainless steel	175.60
	bracket 3" sideways adjustable	20765	77 stainless steel	87.10
	bracket 5" sideways adjustable	20766	77 stainless steel	96.30
	intermediate bracket 3" sideways adjustable	20767	77 stainless steel	147.90
	intermediate bracket 5" sideways adjustable	20768	77 stainless steel	157.10
	extension piece 1" for brackets 20765 - 20768	30719	77 stainless steel	22.10
	bracket Return 20 3 3/4" sideways adjustable	20735	77 stainless steel 77/66 stainless steel/pol. stainless steel	230.60 230.60
	bracket Return 20 5" sideways adjustable	20736	77 stainless steel 77/66 stainless steel/pol. stainless steel	238.80 238.80

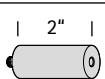
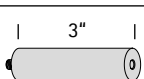
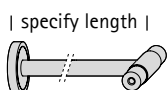
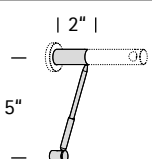
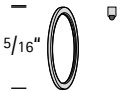
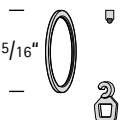
stainless steel 3/4" dia.

components	part	part-no.	color-no.	price
	intermediate bracket Return 20 3 3/4" sideways adjustable	20737	77 stainless steel	160.70
	intermediate bracket Return 20 5" sideways adjustable	20738	77 stainless steel	168.90
	extension piece 3/16" for brackets Return 20	12718	77 stainless steel	15.30
	extension piece 3/4" for brackets Return 20	12618	77 stainless steel	26.80
	extension piece 2" for brackets Return 20	12619	77 stainless steel	33.50
	extension piece 3" for brackets Return 20	12819	77 stainless steel	41.70
specify length 	shorten bracket service e.g. 20768-77-S-4"	S		surcharge 43.00
	bracket support incl. 2" bracket extension for brackets Return 20	12617	77 stainless steel	185.70
	ring 1 5/16" x 1/8" with plastic insert	14679	77 stainless steel	5.10
	ring 1 5/16" x 1/8" with plastic insert with eyelet clip	14678	77 stainless steel	5.30

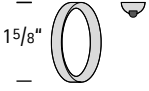
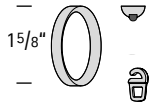
stainless steel 3/4" dia.

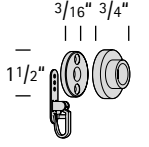
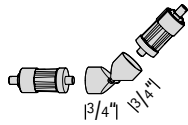
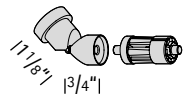
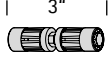
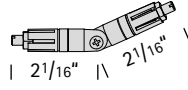
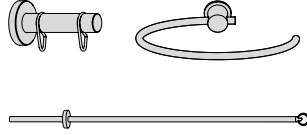
components	part	part-no.	color-no.	price
	ring wide 1 5/8" x 1/4" with plastic insert	25709	77 stainless steel	6.80
	ring wide 1 5/8" x 1/4" with plastic insert with eyelet clip	25708	77 stainless steel	7.00
	eyelet clip for ring	10923	50 white	0.20
	eyelet clip for ring wide	10921	50 white	0.20
	wall socket with anchor clip can be used at both ends	20705	77 stainless steel	56.30
	swivel joint	20651	77 stainless steel	118.20
	wall socket for sloping ceilings one side only	20652	77 stainless steel	142.50
	tube connector	20659	99	18.60
	mitre connector for any angle mitre cut \$ 43.00	20653	99	87.80
	accessories	see page 341		



apollo stainless steel/polished stainless steel



orbit stainless steel/ polished stainless steel



modul stainless steel



tieback with wire stainless steel p. 343

orbit 77/66 stainless steel/polished stainless steel



apollo 77/41 stainless steel/genuine walnut

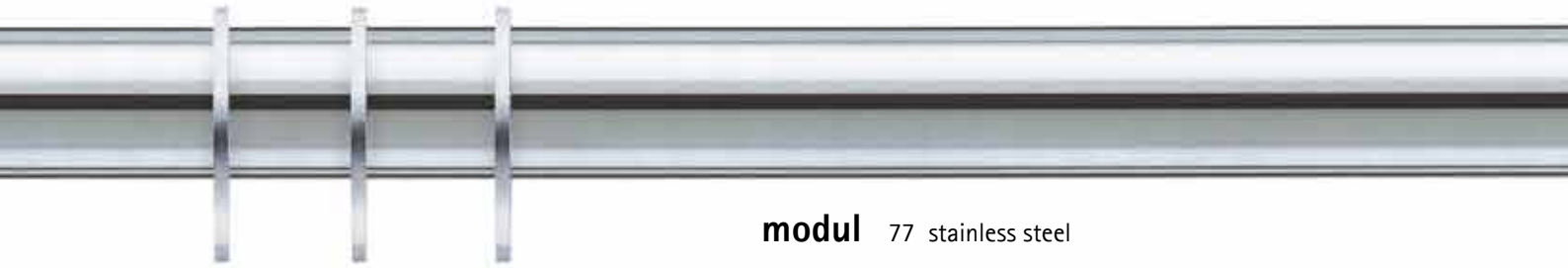

modul 77 stainless steel

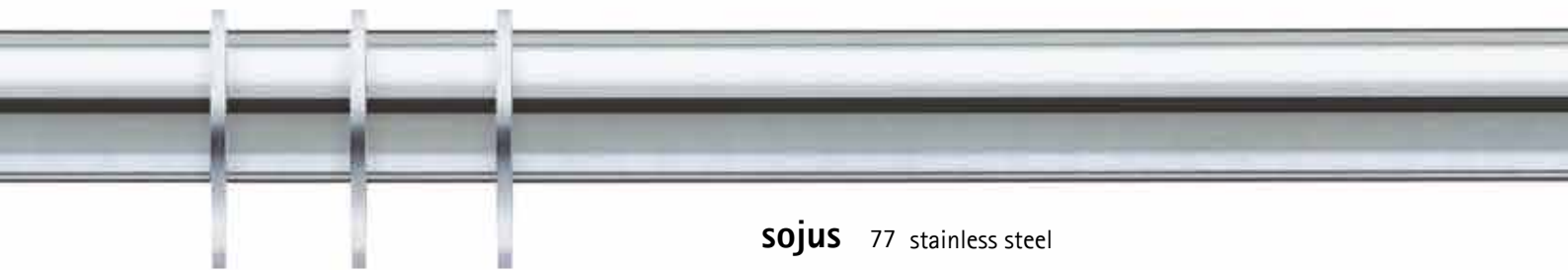

sojus 77 stainless steel

finial orbit



66 polished stainless steel



77 stainless steel



finial apollo



40 genuine beech



41 genuine walnut





66 polished stainless steel



77 stainless steel

stainless steel 3/4" dia.

finish available
77 stainless steel

rings available
 1 ring with plastic insert
 2 ring wide with plastic insert

single rod

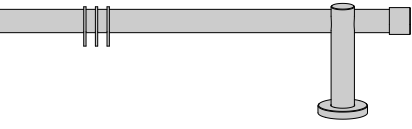

length →

set-no.

 **Modul** 02049

 **Sojus** 02075

length (ft.)	rings	brackets	\$	bracket 3"		bracket 5"		integral	
				1	2	1	2	brackets	surcharge
3	14	2		405	429	422	445	2	306
4	18	2		444	475	461	491	2	316
5	22	3		588	625	613	650	2	221
6	26	3		627	671	652	696	2	231
7	30	3		666	717	691	742	2	241
8	34	3		705	763	730	788	2	251
9	38	4		849	913	882	947	2	156
• 10	42	4		888	959	921	992	3	409
11	48	4		937	1019	971	1052	3	419
12	52	4		976	1065	1010	1098	3	429
13	56	4		1015	1111	1049	1144	3	439
14	60	5		1159	1261	1201	1303	3	344
15	64	5		1198	1307	1240	1349	3	354
16	68	5		1237	1353	1279	1394	3	364
17	72	5		1276	1399	1318	1440	3	374
18	76	5		1315	1445	1357	1486	3	384
reduction per wall socket				82	82	91	91		

double rod

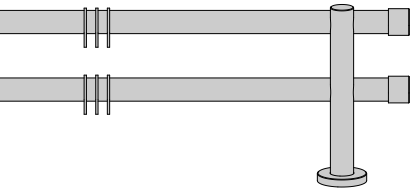

length →



set-no.

 **Modul** 02099

 **Sojus** 02076

length (ft.)	rings	brackets	\$	bracket 3"		bracket 5"		integral	
				1	2	1	2	brackets	surcharge
3	28	2		634	682			2	584
4	36	2		712	773			2	604
5	44	3		912	987			2	502
6	52	3		990	1078			2	522
7	60	3		1068	1170			2	542
8	68	3		1146	1261			2	562
9	76	4		1346	1475			2	460
• 10	84	4		1424	1566			3	864
11	96	4		1523	1686			3	884
12	104	4		1601	1778			3	904
13	112	4		1679	1869			3	924
14	120	5		1879	2083			3	822
15	128	5		1957	2174			3	842
16	136	5		2035	2266			3	862
17	144	5		2113	2357			3	882
18	152	5		2191	2449			3	902
reduction per wall socket				77	77				

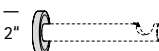
Notes

-  larger base plate + \$ 14.00 per bracket
-  accessories see page 341



• tubes in excess of 9ft. will be delivered in two sections

stainless steel 3/4" dia.



finishes available

- 77 stainless steel
- 77/66 stainless steel/pol. stainless steel
- 77/41 stainless steel/genuine walnut
- 77/40 stainless steel/genuine beech

rings available

-  1 ring with plastic insert
-  2 ring wide with plastic insert

single rod

-  color no. 1
-  color no. 2

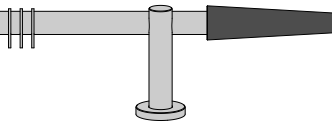

length → 4 1/4" |

set-no.

 **Apollo** 02028

length (ft.)	rings	brackets		bracket 3"		bracket 5"		integral	
				1	2	1	2	brackets	surcharge
3	14	2	\$	513	537	530	553	2	306
4	18	2		552	583	569	599	2	316
5	22	3		696	733	721	758	2	221
6	26	3		735	779	760	804	2	231
7	30	3		774	825	799	850	2	241
8	34	3		813	871	838	896	2	251
9	38	4		957	1021	990	1055	2	156
• 10	42	4		996	1067	1029	1100	3	409
11	48	4		1045	1127	1079	1160	3	419
12	52	4		1084	1173	1118	1206	3	429
13	56	4		1123	1219	1157	1252	3	439
14	60	5		1267	1369	1309	1411	3	344
15	64	5		1306	1415	1348	1457	3	354
16	68	5		1345	1461	1387	1502	3	364
17	72	5		1384	1507	1426	1548	3	374
18	76	5		1423	1553	1465	1594	3	384
reduction per wall socket				136	136	145	145		

double rod

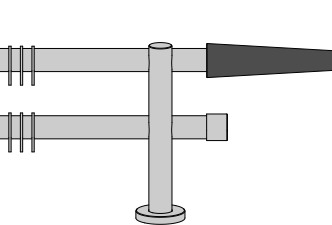



length → 4 1/4" |

set-no.

 **Apollo** 02060

length (ft.)	rings	brackets		bracket 3"				integral	
				1	2			brackets	surcharge
3	28	2	\$	742	790			2	584
4	36	2		820	881			2	604
5	44	3		1020	1095			2	502
6	52	3		1098	1186			2	522
7	60	3		1176	1278			2	542
8	68	3		1254	1369			2	562
9	76	4		1454	1583			2	460
• 10	84	4		1532	1674			3	864
11	96	4		1631	1794			3	884
12	104	4		1709	1886			3	904
13	112	4		1787	1977			3	924
14	120	5		1987	2191			3	822
15	128	5		2065	2282			3	842
16	136	5		2143	2374			3	862
17	144	5		2221	2465			3	882
18	152	5		2299	2557			3	902
reduction per wall socket				131	131				

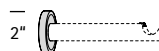
Notes

-  larger base plate + \$ 14.00 per bracket
-  accessories see page 341

- tubes in excess of 9ft. will be delivered in two sections



components see page 329

stainless steel 3/4" dia.



finishes available

77 stainless steel
77/66 stainless steel/pol. stainless steel

rings available

-  1 ring with plastic insert
-  2 ring wide with plastic insert

single rod

 color no. 1
 color no. 2

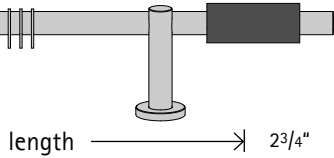

length → 2 3/4" |
set-no. Orbit 02039

length (ft.)	rings	brackets		bracket 3"		bracket 5"		integral	
				1	2	1	2	brackets	surcharge
3	14	2	\$	599	622	615	639	2	306
4	18	2		638	668	654	685	2	316
5	22	3		782	819	806	844	2	221
6	26	3		821	865	845	890	2	231
7	30	3		860	911	884	935	2	241
8	34	3		899	956	923	981	2	251
9	38	4		1042	1107	1076	1140	2	156
• 10	42	4		1081	1153	1115	1186	3	409
11	48	4		1131	1213	1164	1246	3	419
12	52	4		1170	1258	1203	1292	3	429
13	56	4		1209	1304	1242	1337	3	439
14	60	5		1353	1455	1394	1496	3	344
15	64	5		1392	1501	1433	1542	3	354
16	68	5		1431	1547	1472	1588	3	364
17	72	5		1470	1592	1511	1634	3	374
18	76	5		1509	1638	1550	1680	3	384
reduction per wall socket				179	179	188	188		

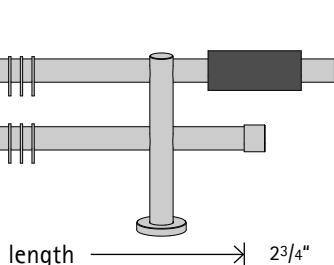

double rod



length → 2 3/4" |
set-no. Orbit 02040



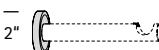

length (ft.)	rings	brackets		bracket 3"		bracket 5"		integral	
				1	2	1	2	brackets	surcharge
3	28	2	\$	828	875			2	584
4	36	2		906	967			2	604
5	44	3		1105	1180			2	502
6	52	3		1183	1272			2	522
7	60	3		1261	1363			2	542
8	68	3		1339	1455			2	562
9	76	4		1539	1668			2	460
• 10	84	4		1617	1760			3	864
11	96	4		1716	1880			3	884
12	104	4		1794	1971			3	904
13	112	4		1872	2063			3	924
14	120	5		2072	2276			3	822
15	128	5		2150	2368			3	842
16	136	5		2228	2459			3	862
17	144	5		2306	2551			3	882
18	152	5		2384	2643			3	902
reduction per wall socket				174	174				

Notes



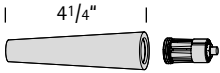
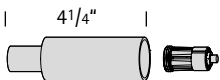
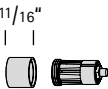
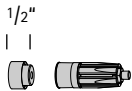
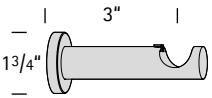

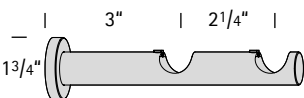
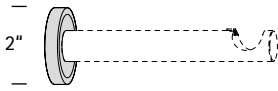
-  larger base plate + \$ 14.00 per bracket
-  accessories see page 341

• tubes in excess of 9ft. will be delivered in two sections

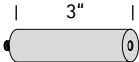
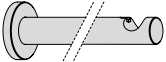
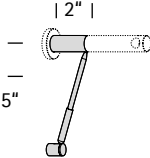
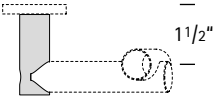
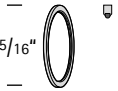
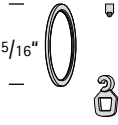

stainless steel 3/4" dia.

components	part	part-no.	color-no.	price
	stainless steel tube 3/4" dia. grind finish	20610	77 stainless steel	Cut to measure \$ / lin. ft. 17.80
	finial Apollo	20761	40 genuine beech 41 genuine walnut 66 polished stainless steel 77 stainless steel	87.80 87.80 87.80 87.80
	finial Orbit	20762	77 stainless steel 77/66 stainless steel/pol. stainless steel	130.60 130.60
	end cap Modul	20769	77 stainless steel	33.80
	end cap Sojus	20929	77 stainless steel	33.80
	bracket 3"	20731	77 stainless steel	104.90
	bracket 5"	20732	77 stainless steel	113.20
	double bracket 3"	20741	77 stainless steel	121.80
	larger base plate for brackets 20731 - 20743 e.g. 20732X	X		surcharge 14.00
	extension piece 3/16" for brackets 20731 - 20743 ceiling converter	12718	77 stainless steel	15.30

stainless steel 3/4" dia.

components	part	part-no.	color-no.	price
	extension piece 3/4" for brackets 20731 - 20743 ceiling converter	12618	77 stainless steel	26.80
	extension piece 2" for brackets 20731 - 20743 ceiling converter	12619	77 stainless steel	33.50
	extension piece 3" for brackets 20731 - 20743 ceiling converter	12819	77 stainless steel	41.70
I specify length I 	shorten bracket service e.g. 20731-77-S-2"	S		surcharge 43.00
	bracket support incl. 2" bracket extension for brackets 20731 - 20743	12617	77 stainless steel	185.70
	ceiling converter for ceiling mounts for brackets 20731 - 20743	16618	77 stainless steel	56.30
	ring 1 5/16" x 1/8" with plastic insert	14679	77 stainless steel	5.10
	ring 1 5/16" x 1/8" with eyelet clip with plastic insert	14678	77 stainless steel	5.30
	ring wide 1 5/8" x 1/4" with plastic insert	25709	77 stainless steel	6.80

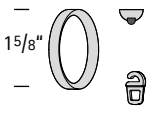
stainless steel 3/4" dia.

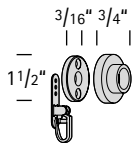
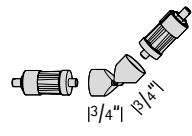
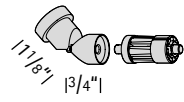
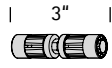
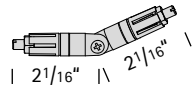
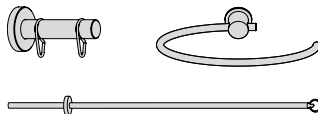
components	part	part-no.	color-no.	price	
	ring wide 1 5/8" x 1/4" with eyelet clip with plastic insert	25708	77	stainless steel	7.00
	eyelet clip for ring	10923	50	white	0.20
	eyelet clip for ring wide	10921	50	white	0.20
	wall socket with anchor clip can be used at both ends	20705	77	stainless steel	56.30
	swivel joint	20651	77	stainless steel	118.20
	wall socket for sloping ceilings one side only	20652	77	stainless steel	142.50
	tube connector	20659	99		18.60
	mitre connector for any angle mitre cut \$ 43.00	20653	99		87.80
	accessories			see page 341	

stainless steel 3/4" dia.

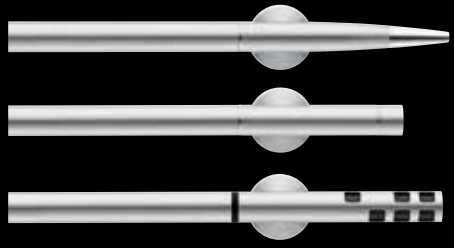

1"
dia.



tangente stainless steel/black



finale stainless steel/polished stainless steel



askese stainless steel



tieback with wire stainless steel p. 343

finale 77/66 stainless steel/polished stainless steel



askese 77/66 stainless steel/polished stainless steel



tangente 77/56 stainless steel/black



scale 1:1



stainless steel 1" dia.

finishes available

- 77 stainless steel
- 77/66 stainless steel/polished stainless steel

single rod

- color no. 1
- color no. 2

brackets sideways adjustable

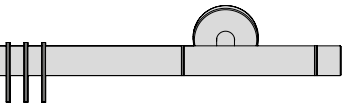

length → |1 1/2" | 3 3/4" |

set-no.

□ Askese 02552

length (ft.)	*rings	brackets	bracket 3"	bracket 5"	integral	brackets surcharge
3	14	2	\$ 775	793	2	306
4	18	2	837	855	2	318
5	22	2	899	918	2	330
▲ 6	26	3	1124	1152	2	179
7	30	3	1186	1214	2	191
8	34	3	1249	1276	2	203
9	38	3	1311	1338	2	215
10	42	3	1373	1401	3	525
▲ 11	48	4	1617	1654	3	374
12	52	4	1680	1716	3	386
13	56	4	1742	1779	3	398
14	60	4	1804	1841	3	410
15	64	4	1866	1903	3	422
16	68	4	1928	1965	3	434
▲ 17	72	5	2153	2199	3	284
18	76	5	2216	2262	3	296
reduction per wall socket			208	217		

▲ tube cut at intermediate bracket.
Off-center cuts on request

Notes

* rings with plastic inserts



accessories



see page 341

stainless steel 1" dia.

finishes available

- 77 stainless steel
- 77/66 stainless steel/polished stainless steel

single rod

-  color no. 1
-  color no. 2

brackets sideways adjustable

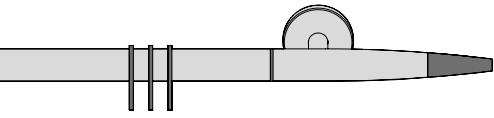

length \rightarrow $1\frac{1}{2}$ " $5\frac{1}{4}$ "

set-no.

 **Finale** 02554

length (ft.)	* rings	brackets	bracket 3"		bracket 5"		integral	
							brackets surcharge	
3	14	2	\$ 806		825		2	306
4	18	2	868		887		2	318
5	22	2	931		949		2	330
▲ 6	26	3	1156		1183		2	179
7	30	3	1218		1245		2	191
8	34	3	1280		1308		2	203
9	38	3	1342		1370		2	215
10	42	3	1404		1432		3	525
▲ 11	48	4	1649		1686		3	374
12	52	4	1711		1748		3	386
13	56	4	1773		1810		3	398
14	60	4	1835		1872		3	410
15	64	4	1898		1934		3	422
16	68	4	1960		1997		3	434
▲ 17	72	5	2185		2231		3	284
18	76	5	2247		2293		3	296
reduction per wall socket			224		233			

▲ tube cut at intermediate bracket.
Off-center cuts on request

Notes

* rings with plastic inserts



accessories

see page 341

stainless steel 1" dia.

finish available

77/56 stainless steel/black

single rod

□ color no. 1
■ color no. 2

brackets sideways adjustable

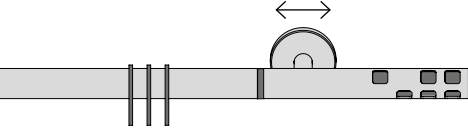

length → 1 1/2" 5 1/2" |

set-no.

 **Tangente** 02558

length (ft.)	*rings	brackets	bracket 3"	bracket 5"	integral	brackets surcharge
3	14	2	\$ 878	897	2	306
4	18	2	940	959	2	318
5	22	2	1003	1021	2	330
▲ 6	26	3	1228	1255	2	179
7	30	3	1290	1317	2	191
8	34	3	1352	1380	2	203
9	38	3	1414	1442	2	215
10	42	3	1476	1504	3	525
▲ 11	48	4	1721	1758	3	374
12	52	4	1783	1820	3	386
13	56	4	1845	1882	3	398
14	60	4	1907	1944	3	410
15	64	4	1970	2006	3	422
16	68	4	2032	2069	3	434
▲ 17	72	5	2257	2303	3	284
18	76	5	2319	2365	3	296
reduction per wall socket			260	269		

▲ tube cut at intermediate bracket.
Off-center cuts on request

Notes



* rings with plastic inserts



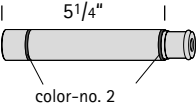
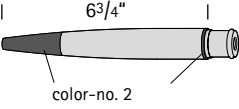
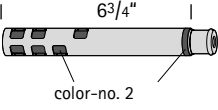
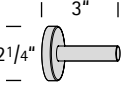
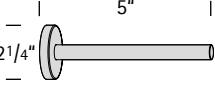
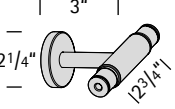
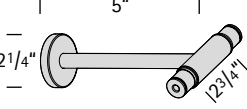

accessories

see page 341

stainless steel 1" dia.

components	part	part-no.	color-no.	price
	stainless steel tube 1" dia. extra fine grind satin finish	25610	77 stainless steel	Cut to measure \$ / lin. ft. 23.00
	finial Askese	25871	77 stainless steel 77/66 stainless steel/pol. stainless steel	191.40 191.40
	finial Finale	25872	77 stainless steel 77/66 stainless steel/pol. stainless steel	207.10 207.10
	finial Tangente	left 25875 right 25876	77/56 stainless steel/black	243.10
	bracket 3" sideways adjustable	25811	77 stainless steel	92.90
	bracket 5" sideways adjustable	25812	77 stainless steel	102.10
	intermediate bracket 3" sideways adjustable	25813	77 stainless steel 77/66 stainless steel/pol. stainless steel	162.70 162.70
	intermediate bracket 5" sideways adjustable	25814	77 stainless steel 77/66 stainless steel/pol. stainless steel	171.90 171.90
	extension piece 1"	30719	77 stainless steel	22.10

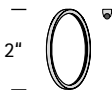
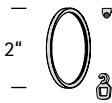
stainless steel 1" dia.

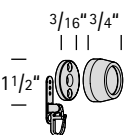
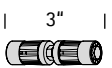
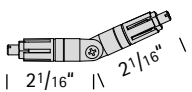
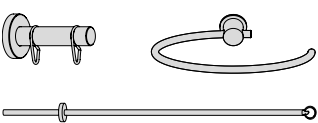
components	part	part-no.	color-no.	price	
 2"	ring 2" x 1/8" with plastic insert	25809	66 77	polished stainless steel stainless steel	9.60 9.60
 2"	ring 2" x 1/8" with eyelet clip with plastic insert	25808	66 77	polished stainless steel stainless steel	9.80 9.80
 3/5"	eyelet clip	10923	50	white	0.20
 3/16" 3/4" 1 1/2"	wall socket with anchor clip can be used at both ends	25705	77	stainless steel	76.10
 3"	tube connector	25659	99		20.00
 2 1/16" 2 1/16"	mitre connector for any angle mitre cut \$ 43.00	25653	99		94.50
	accessories	see page 341			

ACCESSORIES

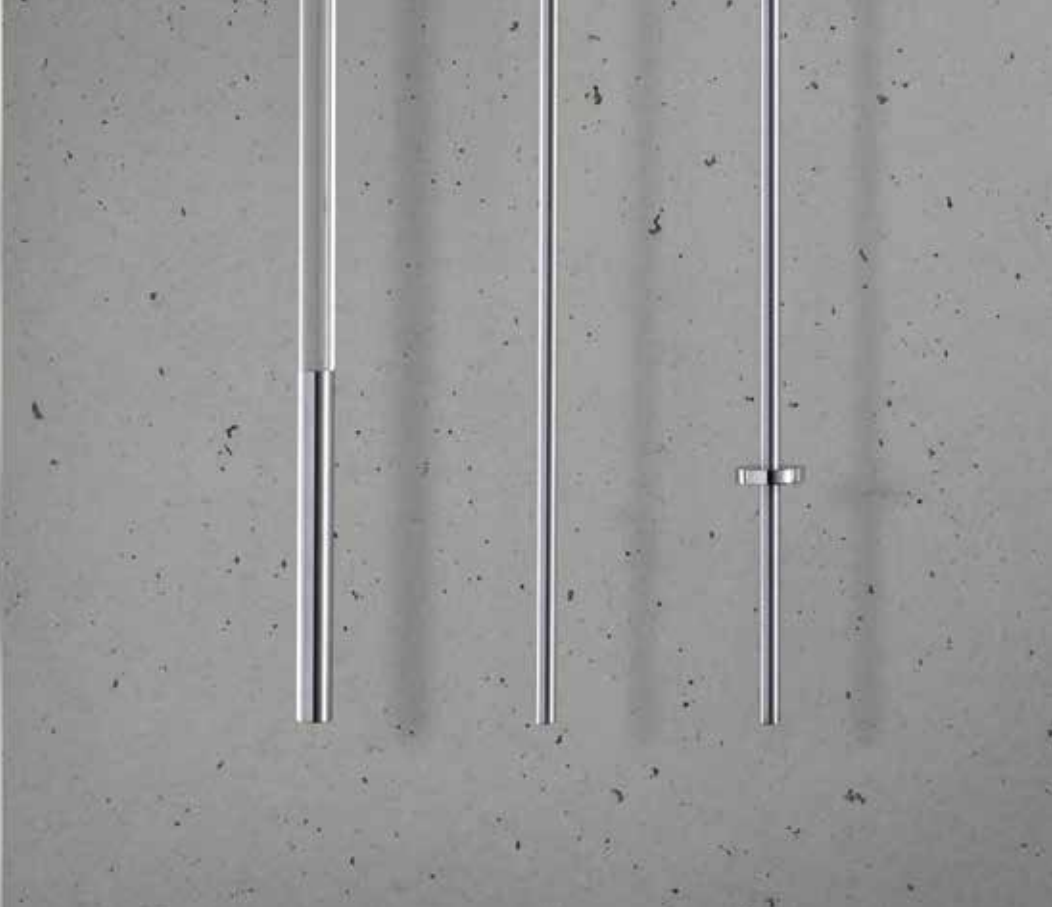

batons	part	part-no.	color-no.	price
	baton 40" material: acrylic glass with metal-grip	10510	90/77 acrylic glass/stainless steel	110.40
	baton 40" 50" 60" 80" 120"	11810 11812 11815 11820 11830	77 stainless steel 77 stainless steel 77 stainless steel 77 stainless steel 77 stainless steel	59.70 65.30 70.90 76.50 104.70
	baton 40" 50" 60"	10813 10812 10815	77 stainless steel 77/66 stainless steel/pol. stainless steel 77 stainless steel 77/66 stainless steel/pol. stainless steel 77 stainless steel 77/66 stainless steel/pol. stainless steel	82.20 82.20 87.80 87.80 93.40 93.40
	shorten baton service e.g. 10812-77-S-43"	S		surcharge 43.00

ACCESSORIES



12796



12691

components	part	part-no.	color-no.	price
	holdback 1" from wall adjustable	12796	77 stainless steel	151.90
	extension piece 2" for holdback 12796	30697	77 stainless steel	47.30
	tieback	12691	77 stainless steel	75.60
	extension piece 3/4" for tieback 12691 for tieback with wire 12694	10718	77 stainless steel	24.50
	extension piece 2" for tieback 12691 for tieback with wire 12694	10719	77 stainless steel	30.40



12694

components

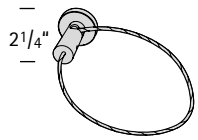

part

tieback with wire
length of wire 32"
wire can be shortened

part-no. color-no.

12694 77 stainless steel

price

131.80

page 352

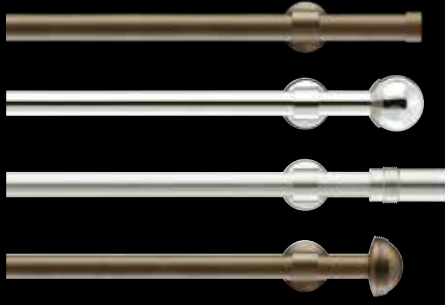

page 376



page 360

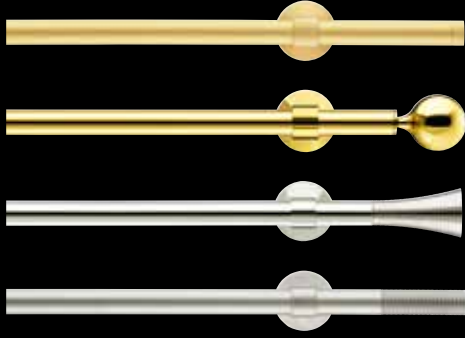

page 380



page 368

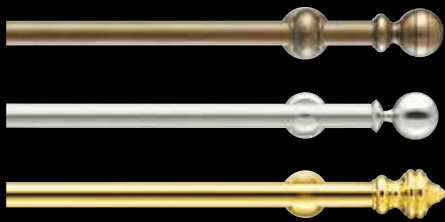

brass

3/4" dia.



atlas polished brass



akzent antique bronzed



step brushed nickel

60 polished brass

62 brushed brass

71 polished nickel

72 brushed nickel

80 antique bronzed

step 80 antique bronzed



atlas 71 polished nickel



akzent 72 brushed nickel



areal 80 antique bronzed



scale 1:1

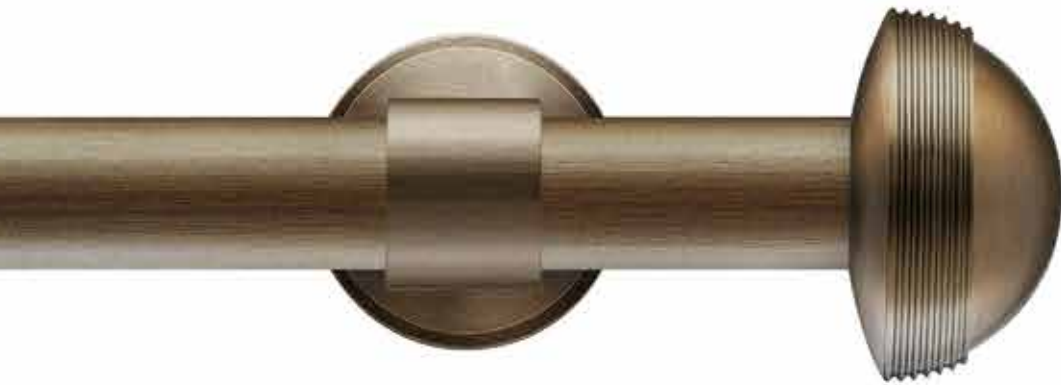
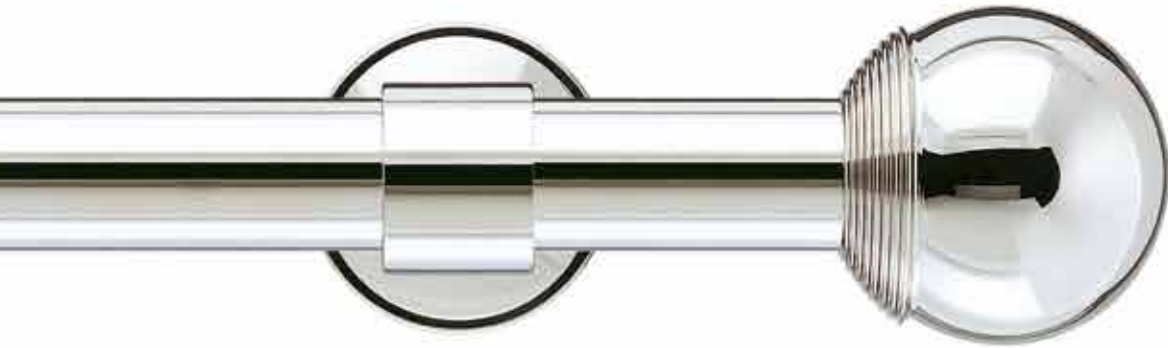

brass 3/4" dia.

finishes available

- A 60 polished brass
- B 62 brushed brass
71 polished nickel
- C 72 brushed nickel
80 antique bronzed

also in combination

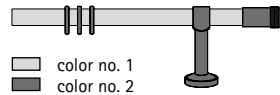

color no. 1
color no. 2
e.g. 60/62 polished brass/brushed brass
price: B 62 brushed brass (higher value price group)

single rod

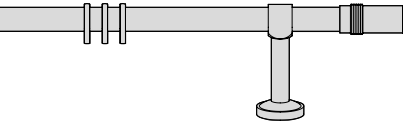

length →

- Atlas 02151
- Areal 02152
- Akzent 02153

length (ft.)	* rings	brackets		brackets 3" or 5"			brackets 7" or 9"			integral	
				A	B	C	A	B	C	brackets	surcharge
3	14	2	\$	440	527	562	467	559	593	2	302
4	18	2		478	572	610	505	603	641	2	312
5	22	3		607	728	776	648	775	823	2	231
6	26	3		646	772	824	686	819	871	2	241
7	30	3		684	816	871	725	864	918	2	251
8	34	3		723	861	919	763	908	966	2	261
9	38	4		852	1017	1085	906	1080	1148	2	181
• 10	42	4		890	1061	1133	944	1124	1196	3	417
11	48	4		937	1114	1190	991	1178	1253	3	427
12	52	4		975	1159	1238	1029	1222	1300	3	437
13	56	4		1013	1203	1285	1067	1266	1348	3	447
14	60	5		1143	1359	1452	1210	1438	1530	3	367
15	64	5		1181	1404	1499	1248	1483	1578	3	377
16	68	5		1219	1448	1547	1287	1527	1625	3	387
17	72	5		1258	1492	1595	1325	1571	1673	3	397
18	76	5		1296	1537	1642	1364	1616	1721	3	407
reduction per wall socket				103	126	135	117	142	150		

double rod

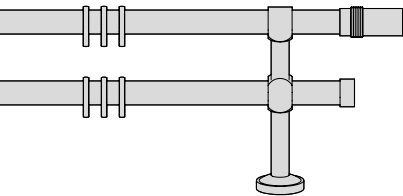

length →

- Atlas 02155
- Areal 02156
- Akzent 02157

length (ft.)	* rings	brackets		brackets 3" or 5"			brackets 7" or 9"			integral	
				A	B	C	A	B	C	brackets	surcharge
3	28	2	\$	733	873	931	760	905	962	2	580
4	36	2		810	962	1026	837	994	1057	2	600
5	44	3		1037	1233	1315	1077	1281	1362	2	470
6	52	3		1114	1322	1410	1154	1369	1457	2	490
7	60	3		1190	1411	1505	1231	1458	1552	2	510
8	68	3		1267	1500	1600	1308	1547	1648	2	530
9	76	4		1494	1771	1889	1548	1834	1952	2	401
• 10	84	4		1570	1859	1985	1624	1923	2047	3	830
11	96	4		1664	1966	2099	1718	2029	2161	3	850
12	104	4		1740	2055	2194	1794	2118	2257	3	870
13	112	4		1817	2144	2289	1871	2207	2352	3	890
14	120	5		2044	2415	2578	2111	2494	2657	3	761
15	128	5		2121	2504	2673	2188	2583	2752	3	781
16	136	5		2197	2592	2768	2265	2671	2847	3	801
17	144	5		2274	2681	2864	2342	2760	2942	3	821
18	152	5		2351	2770	2959	2418	2849	3037	3	841
reduction per wall socket				133	162	173	146	178	188		
additional 3/4" between rods				without surcharge							

Notes

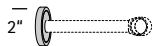

larger base plate + \$ 12.00 per bracket

* rings with plastic insert

• rods in excess of 9ft. will be delivered in two sections
accessories see page 443



brass 3/4" dia.

finishes available

- A 60 polished brass
- B 62 brushed brass
- C 71 polished nickel
- D 72 brushed nickel
- 80 antique bronzed

single rod

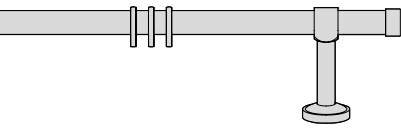

length \rightarrow $1\frac{1}{2}$ "

set-no.

Step 02158

length (ft.)	*rings	brackets		brackets 3" or 5"			brackets 7" or 9"			integral brackets surcharge	
				A	B	C	A	B	C		
3	14	2	\$	357	428	457	384	459	488	2	302
4	18	2		395	472	504	422	504	536	2	312
5	22	3		525	628	671	565	676	718	2	231
6	26	3		563	673	718	603	720	765	2	241
7	30	3		601	717	766	642	764	813	2	251
8	34	3		640	761	814	680	809	861	2	261
9	38	4		769	917	980	823	980	1043	2	181
10	42	4		807	962	1028	861	1025	1090	3	417
11	48	4		854	1015	1085	908	1078	1147	3	427
12	52	4		892	1059	1132	946	1123	1195	3	437
13	56	4		931	1104	1180	985	1167	1243	3	447
14	60	5		1060	1260	1346	1127	1339	1425	3	367
15	64	5		1098	1304	1394	1166	1383	1472	3	377
16	68	5		1137	1349	1442	1204	1428	1520	3	387
17	72	5		1175	1393	1489	1242	1472	1568	3	397
18	76	5		1213	1437	1537	1281	1516	1615	3	407
reduction per wall socket				62	77	82	75	92	98		

surcharge per further 20 cm

double rod

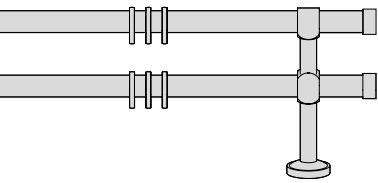

length \rightarrow $1\frac{1}{2}$ "

set-no.

Step 02159

length (ft.)	*rings	brackets		brackets 3" or 5"			brackets 7" or 9"				
				A	B	C	A	B	C		
3	28	2	\$	651	774	825	678	806	857	2	580
4	36	2		727	863	920	754	894	952	2	600
5	44	3		954	1134	1209	994	1181	1257	2	470
6	52	3		1031	1223	1305	1071	1270	1352	2	490
7	60	3		1108	1311	1400	1148	1359	1447	2	510
8	68	3		1184	1400	1495	1225	1448	1542	2	530
9	76	4		1411	1671	1784	1465	1734	1847	2	401
10	84	4		1488	1760	1879	1542	1823	1942	3	830
11	96	4		1581	1867	1993	1635	1930	2056	3	850
12	104	4		1658	1956	2088	1712	2019	2151	3	870
13	112	4		1734	2044	2184	1788	2108	2246	3	890
14	120	5		1961	2315	2473	2028	2394	2551	3	761
15	128	5		2038	2404	2568	2105	2483	2646	3	781
16	136	5		2115	2493	2663	2182	2572	2742	3	801
17	144	5		2191	2582	2758	2259	2661	2837	3	821
18	152	5		2268	2671	2853	2336	2750	2932	3	841
reduction per wall socket				92	112	120	105	128	136		
additional 3/4" between rods				without surcharge							

Notes

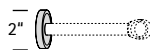

larger base plate + \$ 12.00 per bracket

* rings with plastic insert

• rods in excess of 9ft. will be delivered in two sections







accessories

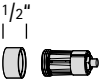

see page 443

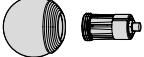
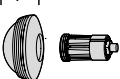
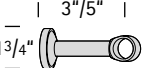
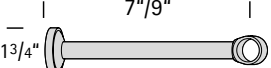
components see page 356

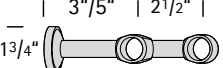
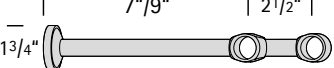

brass 3/4" dia.

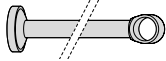
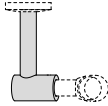
components	part	part-no.	color-no.	price			
	brass tube 3/4" dia.	20610	60	polished brass	Cut to measure \$/lin. ft. 22.00		
			62	brushed brass		26.40	
			71	polished nickel		26.40	
			72	brushed nickel		28.80	
			80	antique bronzed		28.80	
	end cap Step	20729	60	polished brass	26.10		
			62	brushed brass	31.30		
			71	polished nickel	31.30		
			72	brushed nickel	33.30		
			80	antique bronzed	33.30		
  	finial Akzent	20604	60	polished brass	67.50		
			62	brushed brass		81.00	
			71	polished nickel		81.00	
	Atlas	20704	72	brushed nickel	86.00		
			80	antique bronzed	86.00		
			Areal	20804	60	polished brass	90.70
					62	brushed brass	
		bracket	3"	20813	60	polished brass	90.70
				62	brushed brass	111.50	
				71	polished nickel	111.50	
				72	brushed nickel	118.90	
		bracket	5"	20814	80	antique bronzed	118.90
7"				20815	60	polished brass	104.20
				62	brushed brass	127.30	
				71	polished nickel	127.30	
	bracket	9"	20816	72	brushed nickel	134.60	
			80	antique bronzed	134.60		
			3"	20823	60	polished brass	149.70
				62	brushed brass	182.20	
71	polished nickel	182.20					
	double bracket	5"	20824	72	brushed nickel	193.80	
			80	antique bronzed	193.80		
			7"	20825	60	polished brass	163.20
				62	brushed brass	198.00	
71	polished nickel	198.00					
	double bracket	9"	20826	72	brushed nickel	209.50	
			80	antique bronzed	209.50		
			additional distance between rods for double rod	L			without surcharge
					e.g. 20824L		

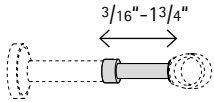
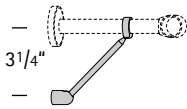
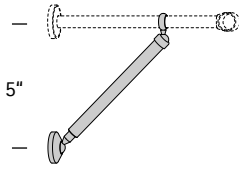
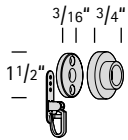
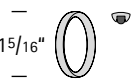
brass 3/4" dia.

components	part	part-no.	color-no.	price
 <p>2"</p>	larger base plate e.g. 20814X	X		surcharge 12.00
 <p>I specify length I</p>	shorten bracket e.g. 20814-62-S-4"	S		surcharge 43.00
	ceiling converter for ceiling mounts			see page 454
 <p>I 1" I</p>	extension piece 1"	30719	60 polished brass 62 brushed brass 71 polished nickel 72 brushed nickel 80 antique bronzed	19.00 22.70 22.70 24.10 24.10
 <p>3/16"-13/4"</p>	extension piece extendable	30619	60 polished brass 62 brushed brass 71 polished nickel 72 brushed nickel 80 antique bronzed	35.60 42.80 42.80 45.20 45.20
 <p>3 1/4"</p>	bracket support light duty can be retrofitted	20617	60 polished brass 62 brushed brass 71 polished nickel 72 brushed nickel 80 antique bronzed	82.20 100.20 100.20 100.20 100.20
 <p>5"</p>	bracket support can be retrofitted	30617	60 polished brass 62 brushed brass 71 polished nickel 72 brushed nickel 80 antique bronzed	180.70 216.60 216.60 228.70 228.70
 <p>3/16" 3/4" 1 1/2"</p>	wall socket with anchor clip can be used at both ends	20705	60 polished brass 62 brushed brass 71 polished nickel 72 brushed nickel 80 antique bronzed	55.20 66.20 66.20 70.30 70.30
 <p>15/16"</p>	ring 15/16" x 3/16" with plastic insert	20909	60 polished brass 62 brushed brass 71 polished nickel 72 brushed nickel 80 antique bronzed	3.90 4.30 4.30 4.50 4.50

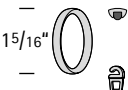
brass 3/4" dia.

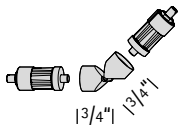
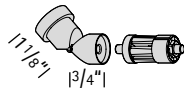
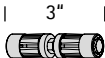
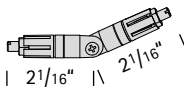
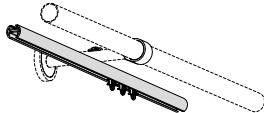
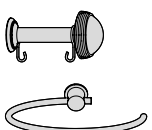
components	part	part-no.	color-no.	price	
	ring 1 ⁵ / ₁₆ " x 3 ³ / ₁₆ " with eyelet clip with plastic insert	20908	60	polished brass	4.10
			62	brushed brass	4.50
			71	polished nickel	4.50
			72	brushed nickel	4.70
			80	antique bronzed	4.70
	eyelet clip	10921	50	white	0.20
	elbow 90° any angle cut to measure from 90° to 160° surcharge \$ 56.00	20650	60	polished brass	123.90
			62	brushed brass	148.60
			71	polished nickel	148.60
			72	brushed nickel	157.40
			80	antique bronzed	157.40
	swivel joint	20651	60	polished brass	111.40
			62	brushed brass	133.70
			71	polished nickel	133.70
			72	brushed nickel	141.90
			80	antique bronzed	141.90
	wall socket for sloping ceilings one side only	20652	60	polished brass	138.40
			62	brushed brass	166.20
			71	polished nickel	166.20
			72	brushed nickel	176.30
			80	antique bronzed	176.30
	tube connector	20659	99		18.60
	mitre connector for any angle mitre cut \$ 43.00	20653	99		87.80
	traversing rod and accessories for extra run			see page 455	
	accessories			see page 443	



legato polished brass



grazioso brushed brass



staccato polished nickel



holdback polished nickel p. 447

finishes available

60 polished brass

62 brushed brass

71 polished nickel

72 brushed nickel

solo 62 brushed brass



grazioso 60 polished brass



legato 71 polished nickel



staccato 72 brushed nickel



scale 1:1

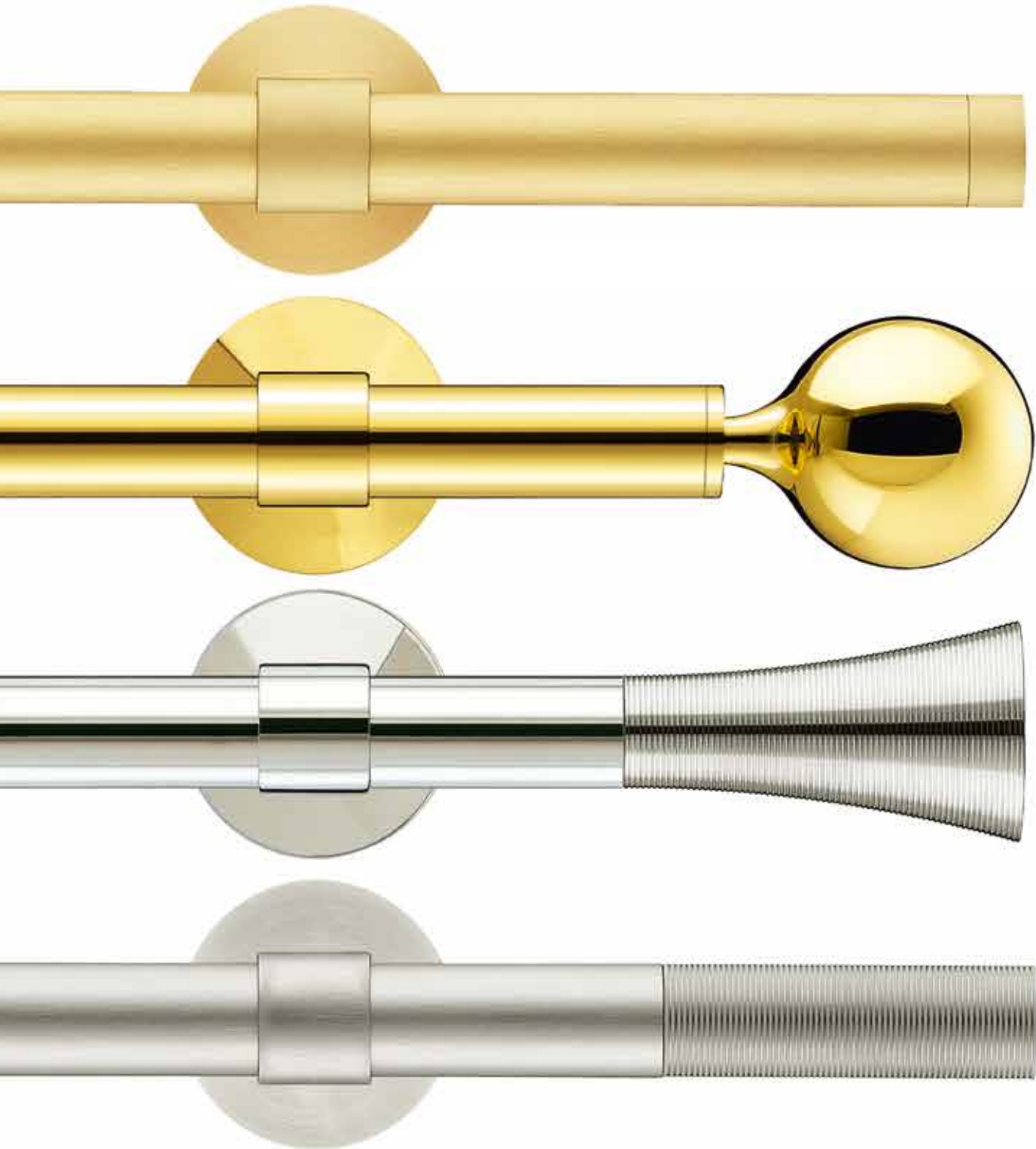

brass 3/4" dia.

finishes available

- A 60 polished brass
- B 62 brushed brass
- 71 polished nickel
- C 72 brushed nickel

single rod

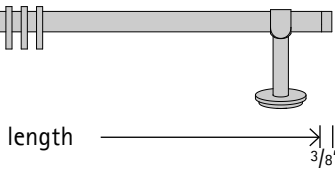

length (ft.)	* rings	brackets		brackets 3" or 5"			brackets 7" or 9"			integral		
				A	B	C	A	B	C	brackets	surcharge	
3	14	2	\$	435	520	552	462	552	583	2	292	
4	18	2		486	580	615	513	612	646	2	302	
5	22	3		632	756	802	673	804	849	2	216	
6	26	3		683	816	865	723	863	912	2	226	
7	30	3		734	875	929	774	923	976	2	236	
8	34	3		785	935	992	825	982	1039	2	246	
9	38	4		931	1111	1179	985	1174	1242	2	161	
• 10	42	4		982	1171	1242	1036	1234	1305	3	397	
11	48	4		1047	1247	1322	1101	1310	1385	3	407	
12	52	4		1098	1306	1386	1152	1370	1448	3	417	
13	56	4		1149	1366	1449	1203	1429	1512	3	427	
14	60	5		1295	1542	1636	1363	1621	1714	3	342	
15	64	5		1346	1602	1699	1413	1681	1778	3	352	
16	68	5		1397	1661	1762	1464	1740	1841	3	362	
17	72	5		1448	1721	1826	1515	1800	1904	3	372	
18	76	5		1498	1781	1889	1566	1860	1967	3	382	
reduction per wall socket					79	96	102	92	112	118		

set-no. 02091

Solo

double rod

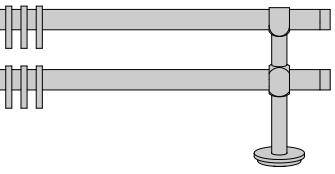

length (ft.)	* rings	brackets		brackets 3" or 5"			brackets 7" or 9"			integral		
				A	B	C	A	B	C	brackets	surcharge	
3	28	2	\$	796	949	1006	823	981	1037	2	570	
4	36	2		898	1068	1132	925	1100	1163	2	590	
5	44	3		1154	1375	1457	1195	1422	1504	2	455	
6	52	3		1256	1494	1584	1296	1541	1631	2	475	
7	60	3		1357	1613	1710	1398	1661	1757	2	495	
8	68	3		1459	1732	1836	1499	1780	1884	2	515	
9	76	4		1715	2039	2162	1769	2102	2224	2	381	
• 10	84	4		1817	2158	2288	1871	2221	2351	3	810	
11	96	4		1947	2310	2449	2001	2374	2512	3	830	
12	104	4		2049	2430	2575	2103	2493	2638	3	850	
13	112	4		2150	2549	2702	2204	2612	2764	3	870	
14	120	5		2407	2855	3027	2474	2934	3105	3	736	
15	128	5		2508	2974	3153	2576	3053	3232	3	756	
16	136	5		2610	3094	3280	2677	3173	3358	3	776	
17	144	5		2712	3213	3406	2779	3292	3485	3	796	
18	152	5		2813	3332	3532	2881	3411	3611	3	816	
reduction per wall socket					121	147	155	134	163	171		
additional 3/4" between rods					without surcharge							

set-no. 02092

Solo

Notes

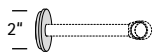

larger base plate + \$ 7.00 per bracket

* rings with plastic insert

• rods in excess of 9ft. will be delivered in two sections
accessories see page 443



brass 3/4" dia.

finishes available

- A 60 polished brass
- B 62 brushed brass
- 71 polished nickel
- C 72 brushed nickel

single rod	length (ft.)	*rings	brackets	brackets 3" or 5"			brackets 7" or 9"			integral		
				A	B	C	A	B	C	brackets surcharge		
 set-no. Grazioso 02093 Legato 02094 Staccato 02097	3	14	2	\$ 592	709	752	619	741	784	2	292	
	4	18	2	643	769	815	670	801	847	2	302	
	5	22	3	790	945	1003	830	993	1050	2	216	
	6	26	3	841	1005	1066	881	1052	1113	2	226	
	7	30	3	891	1064	1129	932	1112	1176	2	236	
	8	34	3	942	1124	1192	983	1171	1239	2	246	
	9	38	4	1089	1300	1379	1143	1363	1442	2	161	
	• 10	42	4	1139	1360	1442	1193	1423	1505	3	397	
	11	48	4	1205	1436	1523	1259	1499	1586	3	407	
	12	52	4	1255	1495	1586	1309	1559	1649	3	417	
	13	56	4	1306	1555	1649	1360	1618	1712	3	427	
	14	60	5	1453	1731	1836	1520	1810	1915	3	342	
	15	64	5	1504	1791	1900	1571	1870	1978	3	352	
	16	68	5	1554	1850	1963	1622	1929	2041	3	362	
	17	72	5	1605	1910	2026	1673	1989	2104	3	372	
	18	76	5	1656	1970	2089	1723	2049	2168	3	382	
				reduction per wall socket	158	191	202	171	207	218		

double rod	length (ft.)	*rings	brackets	brackets 3" or 5"			brackets 7" or 9"			integral		
				A	B	C	A	B	C	brackets surcharge		
 set-no. Grazioso 02095 Legato 02096 Staccato 02098	3	28	2	\$ 954	1138	1206	981	1170	1237	2	570	
	4	36	2	1055	1257	1332	1082	1289	1364	2	590	
	5	44	3	1312	1564	1658	1352	1611	1705	2	455	
	6	52	3	1413	1683	1784	1454	1730	1831	2	475	
	7	60	3	1515	1802	1910	1555	1850	1958	2	495	
	8	68	3	1617	1921	2037	1657	1969	2084	2	515	
	9	76	4	1873	2228	2362	1927	2291	2425	2	381	
	• 10	84	4	1974	2347	2488	2028	2410	2551	3	810	
	11	96	4	2105	2499	2649	2159	2563	2712	3	830	
	12	104	4	2206	2619	2776	2260	2682	2838	3	850	
	13	112	4	2308	2738	2902	2362	2801	2965	3	870	
	14	120	5	2564	3044	3227	2632	3123	3306	3	736	
	15	128	5	2666	3163	3354	2733	3242	3432	3	756	
	16	136	5	2768	3283	3480	2835	3362	3559	3	776	
	17	144	5	2869	3402	3606	2937	3481	3685	3	796	
	18	152	5	2971	3521	3733	3038	3600	3811	3	816	
				reduction per wall socket	200	241	256	213	257	271		
				additional 3/4" between rods	without surcharge							

Notes

larger base plate + \$ 7.00 per bracket









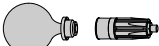

* rings with plastic insert

• rods in excess of 9ft. will be delivered in two sections
accessories see page 443



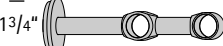
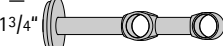
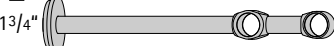
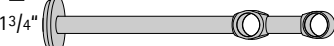

components see page 364

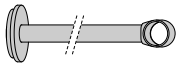

brass 3/4" dia.

components	part	part-no.	color-no.	price		
	brass tube 3/4" dia.	20610	60 polished brass 62 brushed brass 71 polished nickel 72 brushed nickel 80 antique bronzed	Cut to measure \$/lin. ft. 22.00 26.40 26.40 28.80 28.80		
	finial Legato	20901	60 polished brass 62 brushed brass 71 polished nickel 72 brushed nickel	117.10 140.50 140.50 148.80		
	Grazioso	20902				
	Staccato	20903				
	end cap Solo	20929			60 polished brass 62 brushed brass 71 polished nickel 72 brushed nickel	38.30 46.00 46.00 48.60
	bracket	3" 20636			60 polished brass 62 brushed brass	95.70 116.50
		5" 20637			71 polished nickel 72 brushed nickel	116.50 123.90
	bracket	7" 20638	60 polished brass 62 brushed brass	109.20 132.30		
		9" 20639	71 polished nickel 72 brushed nickel	132.30 139.60		
	double bracket	3" 20646	60 polished brass 62 brushed brass	154.70 187.20		
		5" 20647	71 polished nickel 72 brushed nickel	187.20 198.80		
	double bracket	7" 20648	60 polished brass 62 brushed brass	168.20 203.00		
		9" 20649	71 polished nickel 72 brushed nickel	203.00 214.50		
	additional distance between rods for double rod e.g. 20648L	L	without surcharge			

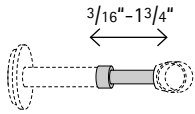
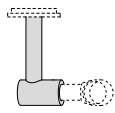
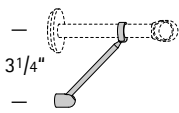
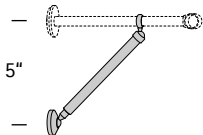
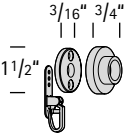
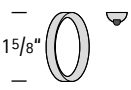
brass 3/4" dia.

components	part	part-no.	color-no.	price
 <p>2"</p>	larger base plate e.g. 20638X	X		surcharge 7.00
 <p> specify length </p>	shorten bracket e.g. 20637-62-S-4"	S		surcharge 43.00
 <p> 1" </p>	extension piece 1"	30719	60 polished brass 62 brushed brass 71 polished nickel 72 brushed nickel	19.00 22.70 22.70 24.10
 <p>3/16" - 1 3/4"</p>	extension piece extendable	30619	60 polished brass 62 brushed brass 71 polished nickel 72 brushed nickel	35.60 42.80 42.80 45.20
	ceiling converter for ceiling mounts			see page 454
 <p>3 1/4"</p>	bracket support light duty can be retrofitted	20617	60 polished brass 62 brushed brass 71 polished nickel 72 brushed nickel	82.20 100.20 100.20 100.20
 <p>5"</p>	bracket support can be retrofitted	30617	60 polished brass 62 brushed brass 71 polished nickel 72 brushed nickel	180.70 216.60 216.60 228.70
 <p>3/16" 3/4" 1 1/2"</p>	wall socket with anchor clip can be used at both ends	20705	60 polished brass 62 brushed brass 71 polished nickel 72 brushed nickel	55.20 66.20 66.20 70.30
 <p>1 5/8"</p>	ring 1 5/8" x 1/4" with plastic insert	25709	60 polished brass 62 brushed brass 71 polished nickel 72 brushed nickel	7.00 8.10 8.10 8.40

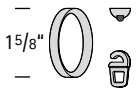
brass 3/4" dia.

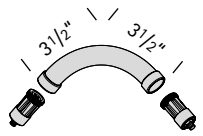
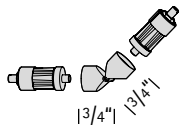
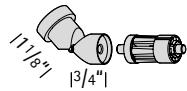
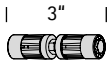
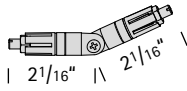
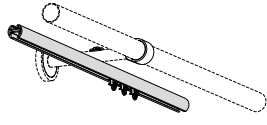
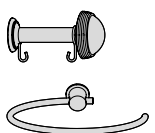
components	part	part-no.	color-no.	price	
	ring 1 5/8" x 1/4" with eyelet clip with plastic insert	25708	60	polished brass	7.20
			62	brushed brass	8.30
			71	polished nickel	8.30
			72	brushed nickel	8.60
	eyelet clip	10921	50	white	0.20
	elbow 90° any angle cut to measure from 90° to 160° surcharge \$ 56.00	20650	60	polished brass	123.90
			62	brushed brass	148.60
			71	polished nickel	148.60
			72	brushed nickel	157.40
			80	antique bronzed	157.40
	swivel joint	20651	60	polished brass	111.40
			62	brushed brass	133.70
			71	polished nickel	133.70
			72	brushed nickel	141.90
			80	antique bronzed	141.90
	wall socket for sloping ceilings one side only	20652	60	polished brass	138.40
			62	brushed brass	166.20
			71	polished nickel	166.20
			72	brushed nickel	176.30
			80	antique bronzed	176.30
	tube connector	20659	99		18.60
	mitre connector for any angle mitre cut \$ 43.00	20653	99		87.80
	traversing rod and accessories for extra run	see page 455			
	accessories	see page 443			



iris polished brass



imola antique bronzed



indigo antique bronzed



tiebacks polished brass p. 448

finishes available

60 polished brass

62 brushed brass

72 brushed nickel

80 antique bronzed

imola 80 antique bronzed



iris 72 brushed nickel



indigo 60 polished brass



scale 1:1

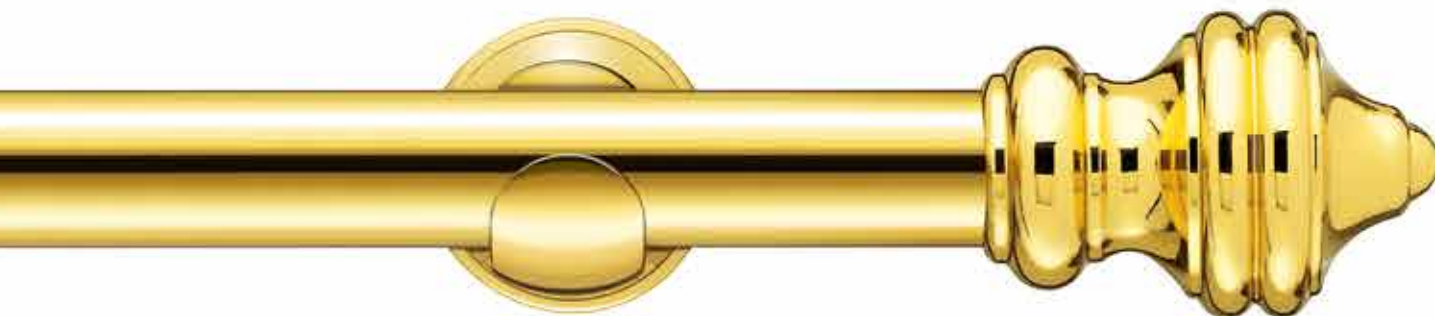

brass 3/4" dia.

finishes available

- A 60 polished brass
- B 62 brushed brass
- C 72 brushed nickel
- 80 antique bronzed

single rod (open bracket)	length (ft.)	* rings	brackets	brackets 3" or 5"			brackets 7" or 9"			integral		
				A	B	C	A	B	C	brackets surcharge		
<p>length →</p> <p>set-no.</p> <p> Indigo 02041 ○smooth</p> <p> Imola 02043 ○smooth</p> <p> Iris 02029 ○smooth</p>	3	14	2	\$ 433	518	552	460	550	583	2	302	
	4	18	2	476	568	605	503	600	636	2	312	
	5	22	3	610	729	776	650	776	823	2	232	
	6	26	3	653	779	830	693	826	877	2	242	
	7	30	3	696	829	883	736	876	930	2	252	
	8	34	3	739	879	936	780	926	983	2	262	
	9	38	4	872	1039	1107	926	1102	1170	2	182	
	• 10	42	4	916	1089	1161	970	1152	1223	3	418	
	11	48	4	969	1151	1226	1023	1214	1289	3	428	
	12	52	4	1013	1201	1279	1067	1264	1342	3	438	
	13	56	4	1056	1251	1332	1110	1314	1395	3	448	
	14	60	5	1189	1412	1504	1257	1491	1582	3	368	
	15	64	5	1232	1462	1557	1300	1541	1636	3	378	
	16	68	5	1276	1512	1610	1343	1591	1689	3	388	
	17	72	5	1319	1562	1664	1386	1641	1742	3	398	
	18	76	5	1362	1612	1717	1429	1691	1795	3	408	
	reduction per wall socket				91	112	120	105	128	135		

double rod (open bracket)	length (ft.)	* rings	brackets	brackets 3" or 5"			brackets 7" or 9"			integral		
				A	B	C	A	B	C	brackets surcharge		
<p>length →</p> <p>set-no.</p> <p> Indigo 02045 ○smooth</p> <p> Imola 02047 ○smooth</p> <p> Iris 02030 ○smooth</p> <p> 3/4" </p>	3	28	2	\$ 739	878	934	766	910	965	2	580	
	4	36	2	825	978	1040	852	1010	1072	2	600	
	5	44	3	1058	1257	1337	1099	1304	1384	2	473	
	6	52	3	1145	1357	1444	1185	1404	1491	2	493	
	7	60	3	1231	1457	1550	1272	1504	1597	2	513	
	8	68	3	1318	1557	1656	1358	1604	1703	2	533	
	9	76	4	1551	1836	1953	1605	1899	2016	2	406	
	• 10	84	4	1637	1936	2059	1691	1999	2122	3	833	
	11	96	4	1745	2059	2190	1799	2122	2253	3	853	
	12	104	4	1831	2159	2297	1885	2222	2359	3	873	
	13	112	4	1918	2259	2403	1972	2322	2466	3	893	
	14	120	5	2151	2538	2700	2218	2617	2778	3	766	
	15	128	5	2237	2638	2806	2305	2717	2885	3	786	
	16	136	5	2324	2738	2913	2391	2817	2991	3	806	
	17	144	5	2410	2838	3019	2478	2917	3097	3	826	
	18	152	5	2496	2938	3125	2564	3017	3204	3	846	
	reduction per wall socket				119	145	155	132	161	170		
	additional 3/4" between rods				without surcharge							

Notes



larger base plate + \$ 12.00 per bracket

* rings with plastic insert

• rods in excess of 9ft. will be delivered in two sections



accessories

see page 443

brass 3/4" dia.

finishes available

- A 60 polished brass
- B 80 antique bronzed

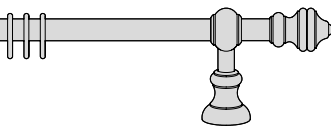
single rod (closed bracket)	length (ft.)	*rings	brackets	brackets 3" or 5"		brackets 7" or 9"		integral		
				A	B	A	B	brackets surcharge		
 <p>length →</p> <p>set-no.</p> <p>Indigo 02031 ○ smooth * 02032 ⊗ fluted</p> <p>Imola 02033 ○ smooth * 02034 ⊗ fluted</p>	3	14	2	\$ 452	569	479	600	2	278	
	4	18	2	495	622	522	654	2	288	
	5	22	3	638	802	679	850	2	198	
	6	26	3	682	856	722	903	2	208	
	7	30	3	725	909	765	956	2	218	
	8	34	3	768	962	808	1009	2	228	
	9	38	4	911	1142	965	1205	2	139	
	• 10	42	4	954	1195	1008	1258	3	372	
	11	48	4	1008	1261	1062	1324	3	382	
	12	52	4	1051	1314	1105	1377	3	392	
	13	56	4	1094	1367	1148	1430	3	402	
	14	60	5	1237	1547	1305	1626	3	313	
	15	64	5	1280	1601	1348	1679	3	323	
	16	68	5	1324	1654	1391	1732	3	333	
	17	72	5	1367	1707	1434	1786	3	343	
	18	76	5	1410	1760	1477	1839	3	353	
				reduction per wall socket	101	128	114	144		

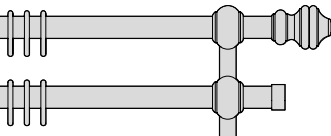
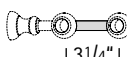



double rod (closed bracket)	length (ft.)	*rings	brackets	brackets 3" or 5"		brackets 7" or 9"		integral		
				A	B	A	B	brackets surcharge		
 <p>length →</p> <p>set-no.</p> <p>Indigo 02035 ○ smooth * 02036 ⊗ fluted</p> <p>Imola 02037 ○ smooth * 02038 ⊗ fluted</p> <p> 1 3/4"</p>	3	28	2	\$ 754	946	781	977	2	556	
	4	36	2	840	1052	867	1083	2	576	
	5	44	3	1081	1355	1121	1402	2	442	
	6	52	3	1167	1461	1208	1508	2	462	
	7	60	3	1253	1567	1294	1614	2	482	
	8	68	3	1340	1674	1380	1721	2	502	
	9	76	4	1580	1976	1634	2039	2	368	
	• 10	84	4	1667	2083	1721	2145	3	790	
	11	96	4	1774	2213	1828	2276	3	810	
	12	104	4	1861	2320	1915	2383	3	830	
	13	112	4	1947	2426	2001	2489	3	850	
	14	120	5	2188	2729	2255	2807	3	716	
	15	128	5	2274	2835	2342	2914	3	736	
	16	136	5	2361	2942	2428	3020	3	756	
	17	144	5	2447	3048	2515	3126	3	776	
	18	152	5	2533	3154	2601	3233	3	796	
				reduction per wall socket	126	160	140	176		
				additional 3/4" between rods	without surcharge					

Notes



- * integral not available for fluted tubes
 - * rings with plastic insert
 - rods in excess of 9ft. will be delivered in two sections
- accessories see page 443

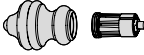
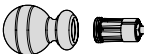

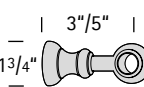
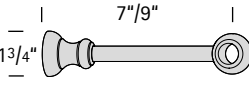
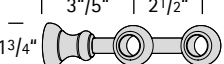
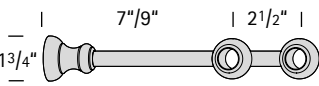
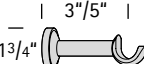

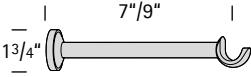
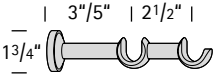
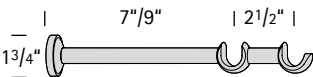
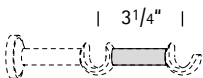
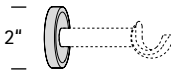
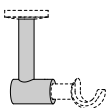

brass 3/4" dia.

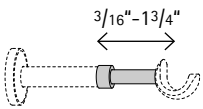
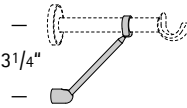
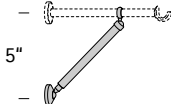
components	part	part-no.	color-no.	price	
	brass tube 3/4" dia. smooth	20610	60 polished brass	Cut to measure \$/ lin. ft. 22.00	
			62 brushed brass		26.40
			72 brushed nickel		28.80
			80 antique bronzed		28.80
	brass tube 3/4" dia. fluted	20630	60 polished brass	Cut to measure \$/ lin. ft. 22.00	
			80 antique bronzed		28.80
 2 1/4"  2 1/4"  2 1/4"	finial Indigo	20601			
	finial Imola	20602	60 polished brass	56.30	
	finial Iris		62 brushed brass	67.50	
72 brushed nickel			71.60		
		20702	80 antique bronzed	71.60	
	end cap	20729	60 polished brass	26.10	
			62 brushed brass	31.30	
			72 brushed nickel	33.30	
			80 antique bronzed	33.30	
 3 5/8" 1 3/4"	bracket closed	3" 20611	60 polished brass	99.70	
		80 antique bronzed	127.00		
		5" 20612			
 7 9/16" 1 3/4"	bracket closed	7" 20613	60 polished brass	113.20	
		80 antique bronzed	142.70		
		9" 20614			
 3 5/8" 2 1/2" 1 3/4"	double bracket closed	3" 20621	60 polished brass	154.20	
		80 antique bronzed	196.10		
		5" 20622			
 7 9/16" 2 1/2" 1 3/4"	double bracket closed	7" 20623	60 polished brass	167.70	
		80 antique bronzed	211.80		
		9" 20624			
 3 5/8" 1 3/4"	bracket open	3" 20631	60 polished brass	90.10	
			62 brushed brass	110.60	
		5" 20632	72 brushed nickel	118.30	
			80 antique bronzed	118.30	

brass 3/4" dia.

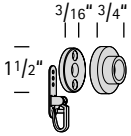
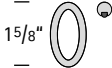
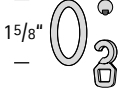
components	part	part-no.	color-no.	price
	bracket open	7"	20633	60 polished brass 103.60
				62 brushed brass 126.40
				72 brushed nickel 134.00
		9"	20634	80 antique bronzed 134.00
	double bracket open	3"	20641	60 polished brass 146.80
				62 brushed brass 178.60
				72 brushed nickel 190.30
		5"	20642	80 antique bronzed 190.30
	double bracket open	7"	20643	60 polished brass 160.30
				62 brushed brass 194.40
				72 brushed nickel 206.00
		9"	20644	80 antique bronzed 206.00
	additional distance between rods for double rod e.g. 20643L	L		without surcharge
	larger base plate for brackets 20631 - 20664 e.g. 20632X	X		surcharge 12.00
	ceiling converter for ceiling mounts			see page 454
	extension piece 1"	30719	60 polished brass 19.00	
			62 brushed brass 22.70	
			72 brushed nickel 24.10	
			80 antique bronzed 24.10	
	extension piece extendable	30619	60 polished brass 35.60	
			62 brushed brass 42.80	
			72 brushed nickel 45.20	
			80 antique bronzed 45.20	
	bracket support light duty can be retrofitted	20617	60 polished brass 82.20	
			62 brushed brass 100.20	
			72 brushed nickel 100.20	
			80 antique bronzed 100.20	
	bracket support can be retrofitted	30617	60 polished brass 180.70	
			62 brushed brass 216.60	
			72 brushed nickel 228.70	
			80 antique bronzed 228.70	

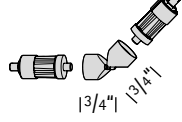
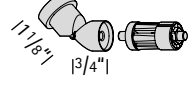
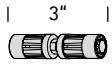
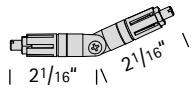
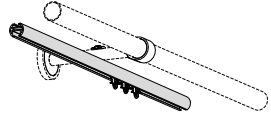
brass 3/4" dia.

components	part	part-no.	color-no.	price	
	wall socket with anchor clip can be used at both ends	20705	60 62 72 80	polished brass brushed brass brushed nickel antique bronzed	55.20 66.20 70.30 70.30
	ring 1 5/8" x 3/16" with plastic insert	20709	60 62 72 80	polished brass brushed brass brushed nickel antique bronzed	5.10 5.70 5.90 5.90
	ring 1 5/8" x 3/16" with eyelet clip with plastic insert	20708	60 62 72 80	polished brass brushed brass brushed nickel antique bronzed	5.30 5.90 6.10 6.10
	eyelet clip	10925	50	white	0.20
	elbow 90° any angle cut to measure from 90° to 160° not for fluted tube surcharge \$ 56.00	20650	60 62 72 80	polished brass brushed brass brushed nickel antique bronzed	123.90 148.60 157.40 157.40
	swivel joint not for fluted tube	20651	60 62 72 80	polished brass brushed brass brushed nickel antique bronzed	111.40 133.70 141.90 141.90
	wall socket for sloping ceilings one side only not for fluted tube	20652	60 62 72 80	polished brass brushed brass brushed nickel antique bronzed	138.40 166.20 176.30 176.30
	tube connector for smooth tube	20659	99		18.60
	for fluted tube	20658	99		18.60
	mitre connector for any angle not for fluted tube mitre cut \$ 43.00	20653	99		87.80
	traversing rod and accessories for extra run			see page 455	
	accessories			see page 443	



cosima brushed nickel



aida antique bronzed



julia anthracite/brushed brass



51 anthracite 72 brushed nickel 80 antique bronzed

tube, rings, brackets

51 anthracite

72 brushed nickel

80 antique bronzed

finial, bracket bowl



62 brushed brass

72 brushed nickel

80 antique bronzed

88 gold leaf patina

cosima 80 antique bronzed



aida 72/88 brushed nickel/gold leaf patina



julia 51/72 anthracite/brushed nickel



scale 1:1



brass 3/4" dia.

finishes available

- A 51/62 anthracite/brushed brass
- B 51/72 anthracite/brushed nickel
- C 72 brushed nickel
- 72/88 brushed nickel/gold leaf patina
- 80 antique bronzed

single rod

□ color no. 1
■ color no. 2

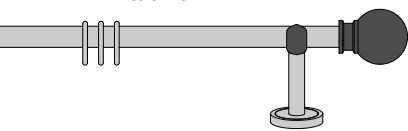

length →

set-no.

- Julia** 02058
- Aida** 02087
- Cosima** 02089

length (ft.)	* rings	brackets		brackets 3" or 5"			brackets 7" or 9"			integral		
				A	B	C	A	B	C	brackets	surcharge	
3	14	2	\$	806	905	933	833	932	964	2	306	
4	18	2		856	955	986	883	982	1017	2	316	
5	22	3		1043	1155	1198	1084	1195	1245	2	189	
6	26	3		1093	1205	1251	1134	1245	1298	2	199	
7	30	3		1143	1255	1304	1184	1295	1351	2	209	
8	34	3		1193	1305	1357	1234	1345	1404	2	219	
9	38	4		1381	1505	1569	1435	1559	1632	2	91	
• 10	42	4		1431	1555	1622	1485	1609	1685	3	377	
11	48	4		1492	1616	1688	1546	1670	1750	3	387	
12	52	4		1542	1666	1741	1596	1720	1804	3	397	
13	56	4		1592	1716	1794	1646	1770	1857	3	407	
14	60	5		1780	1916	2006	1847	1984	2084	3	279	
15	64	5		1830	1966	2059	1897	2034	2138	3	289	
16	68	5		1880	2016	2112	1947	2084	2191	3	299	
17	72	5		1930	2066	2165	1997	2134	2244	3	309	
18	76	5		1980	2116	2219	2047	2184	2297	3	319	
▲ reduction per wall socket					256	305	310	269	319	326		

double rod

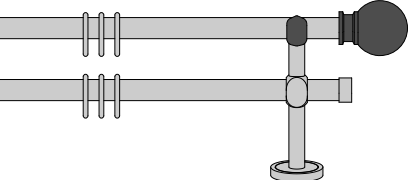

length →

set-no.

- Julia** 02059
- Aida** 02088
- Cosima** 02090

length (ft.)	* rings	brackets		brackets 3" or 5"			brackets 7" or 9"			integral		
				A	B	C	A	B	C	brackets	surcharge	
3	28	2	\$	1172	1271	1321	1199	1298	1352	2	584	
4	36	2		1272	1371	1427	1299	1398	1459	2	604	
5	44	3		1580	1691	1767	1620	1732	1814	2	416	
6	52	3		1680	1791	1874	1720	1832	1921	2	436	
7	60	3		1780	1891	1980	1820	1932	2027	2	456	
8	68	3		1880	1991	2086	1920	2032	2133	2	476	
9	76	4		2188	2312	2426	2242	2366	2489	2	288	
• 10	84	4		2288	2412	2533	2342	2466	2595	3	778	
11	96	4		2411	2535	2663	2465	2589	2726	3	798	
12	104	4		2511	2635	2770	2565	2689	2833	3	818	
13	112	4		2611	2735	2876	2665	2789	2939	3	838	
14	120	5		2920	3056	3216	2987	3123	3295	3	650	
15	128	5		3020	3156	3323	3087	3223	3401	3	670	
16	136	5		3120	3256	3429	3187	3323	3507	3	690	
17	144	5		3220	3356	3535	3287	3423	3614	3	710	
18	152	5		3320	3456	3642	3387	3523	3720	3	730	
▲ reduction per wall socket					292	341	348	305	355	364		
additional 3/4" between rods					without surcharge							

Notes

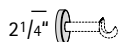

larger base plate + \$ 14.00 per bracket

* rings with plastic inserts

• rods in excess of 9ft. will be delivered in two sections

▲ position wall socket left/right, please specify



hamlet antique bronzed



silva polished brass/brass patina



holdback antique bronzed p. 450



finishes available

60 polished brass

62 brushed brass

72 brushed nickel
(silva only)

80 antique bronzed

silva 72/88 brushed nickel/gold leaf patina



hamlet 62/67 brushed brass/brass patina



scale 1:1.5

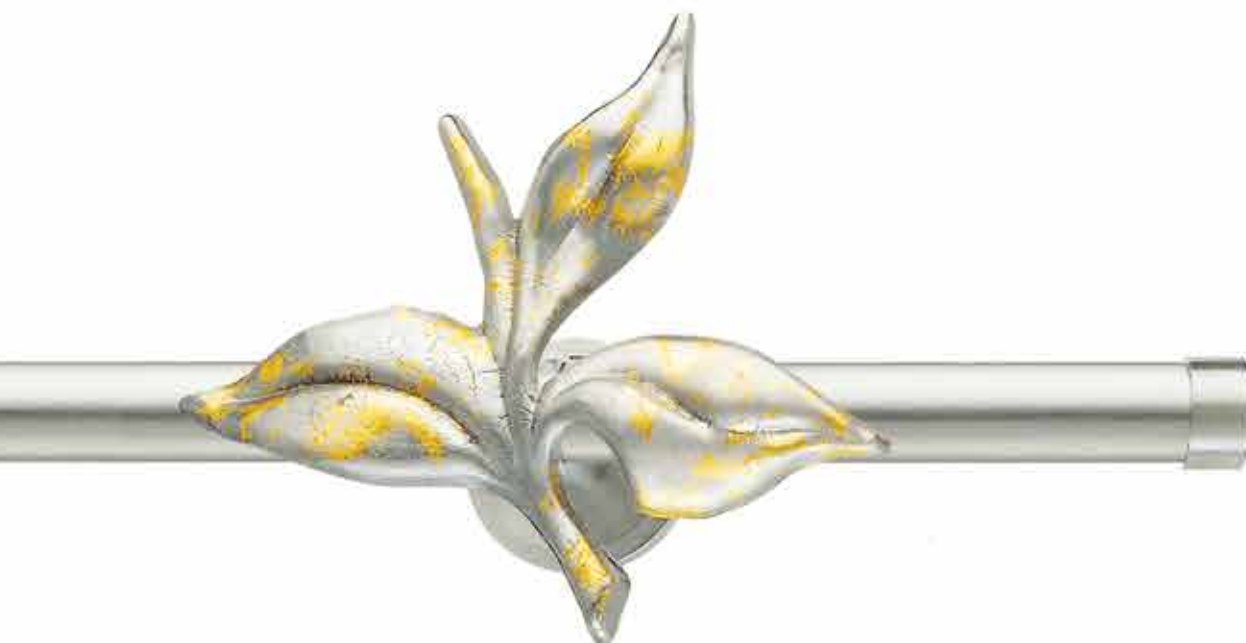

finials



67 brass patina



80 antique bronzed



88 gold leaf patina
(silva only)

brass 3/4" dia.

finishes available

- A 60/67 polished brass/brass patina
- B 62/67 brushed brass/brass patina (smooth tube only)
- C 72/88 brushed nickel/gold leaf patina (smooth tube only)
- 80 antique bronzed

single rod

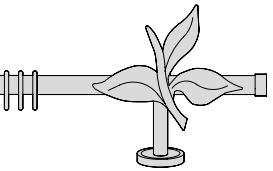

length \rightarrow $\frac{1}{2}$ "

set-no.



Silva 02121 \circ smooth
 ■ 02122 \odot fluted

length (ft.)	* rings	brackets		brackets 3" or 5"			brackets 7" or 9"			integral	
				A	B	C	A	B	C	brackets	surcharge
3	14	2	\$	748	824	872	775	855	903	2	306
4	18	2		791	874	925	818	905	956	2	316
5	22	3		937	1047	1109	978	1095	1156	2	223
6	26	3		980	1097	1162	1021	1145	1209	2	233
7	30	3		1024	1147	1215	1064	1195	1262	2	243
8	34	3		1067	1197	1269	1107	1245	1316	2	253
9	38	4		1213	1371	1453	1267	1434	1515	2	161
10	42	4	•	1256	1421	1506	1310	1484	1569	3	411
11	48	4		1310	1482	1571	1364	1546	1634	3	421
12	52	4		1353	1532	1624	1407	1596	1687	3	431
13	56	4		1396	1582	1678	1450	1646	1740	3	441
14	60	5		1542	1756	1862	1609	1835	1940	3	349
15	64	5		1585	1806	1915	1653	1885	1993	3	359
16	68	5		1628	1856	1968	1696	1935	2047	3	369
17	72	5		1672	1906	2021	1739	1985	2100	3	379
18	76	5		1715	1956	2075	1782	2035	2153	3	389
reduction per wall socket				249	265	280	262	281	295		

double rod

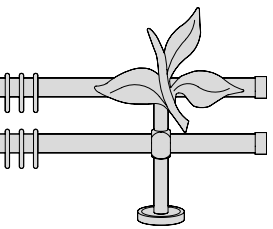

length \rightarrow $\frac{1}{2}$ "

set-no.



Silva 02123 \circ smooth
 ■ 02124 \odot fluted

length (ft.)	* rings	brackets		brackets 3" or 5"			brackets 7" or 9"			integral	
				A	B	C	A	B	C	brackets	surcharge
3	28	2	\$	1058	1189	1260	1085	1221	1291	2	584
4	36	2		1145	1289	1366	1172	1321	1398	2	604
5	44	3		1393	1584	1678	1433	1631	1726	2	462
6	52	3		1479	1684	1785	1520	1731	1832	2	482
7	60	3		1566	1784	1891	1606	1831	1938	2	502
8	68	3		1652	1884	1998	1693	1931	2045	2	522
9	76	4		1900	2178	2310	1954	2241	2373	2	381
10	84	4	•	1987	2278	2416	2041	2341	2479	3	824
11	96	4		2094	2401	2547	2148	2465	2610	3	844
12	104	4		2181	2501	2653	2235	2565	2716	3	864
13	112	4		2267	2601	2760	2321	2665	2823	3	884
14	120	5		2515	2896	3072	2583	2975	3151	3	743
15	128	5		2602	2996	3178	2669	3075	3257	3	763
16	136	5		2688	3096	3285	2755	3175	3363	3	783
17	144	5		2774	3196	3391	2842	3275	3470	3	803
18	152	5		2861	3296	3498	2928	3375	3576	3	823
reduction per wall socket				279	301	318	292	316	333		
additional 3/4" between rods				without surcharge							

Notes

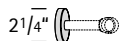

larger base plate + \$ 14.00 per bracket
 intermediate bracket without rosette

* rings with plastic inserts

• rods in excess of 9ft. will be delivered in two sections

■ integral not available for fluted tubes

brass 3/4" dia.

finishes available

- A 80 antique bronzed
- B 60/67 polished brass/brass patina
- C 62/67 brushed brass/brass patina

single rod

□ color no. 1
■ color no. 2

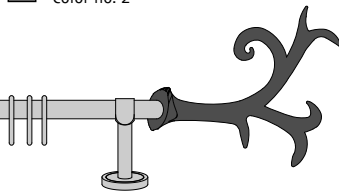

length → 9"

set-no.
Hamlet 02069

length (ft.)	*rings	brackets	brackets 3" or 5"			brackets 7" or 9"			integral	
			A	B	C	A	B	C	brackets	surcharge
3	14	2	\$ 1133	1081	1151	1164	1108	1183	2	306
4	18	2	1194	1130	1209	1225	1157	1241	2	316
5	22	3	1386	1282	1390	1433	1322	1438	2	223
6	26	3	1447	1330	1448	1494	1371	1495	2	233
7	30	3	1508	1379	1505	1555	1420	1553	2	243
8	34	3	1570	1428	1563	1617	1468	1610	2	253
9	38	4	1762	1579	1744	1824	1633	1807	2	161
• 10	42	4	1823	1628	1802	1886	1682	1865	3	411
11	48	4	1900	1690	1875	1963	1744	1938	3	421
12	52	4	1961	1739	1932	2024	1793	1996	3	431
13	56	4	2023	1788	1990	2085	1842	2053	3	441
14	60	5	2215	1940	2171	2293	2007	2250	3	349
15	64	5	2276	1988	2229	2354	2056	2308	3	359
16	68	5	2337	2037	2286	2416	2105	2365	3	369
17	72	5	2398	2086	2344	2477	2153	2423	3	379
18	76	5	2460	2135	2402	2538	2202	2481	3	389
^reduction per wall socket			396	406	415	412	419	431		

double rod

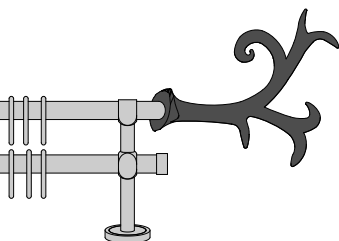

length → 9"

set-no.
Hamlet 02070

length (ft.)	*rings	brackets	brackets 3" or 5"			brackets 7" or 9"			integral	
			A	B	C	A	B	C	brackets	surcharge
3	28	2	\$ 1549	1411	1544	1580	1438	1575	2	584
4	36	2	1671	1509	1659	1703	1536	1691	2	604
5	44	3	1999	1768	1968	2047	1809	2016	2	462
6	52	3	2122	1866	2084	2169	1906	2131	2	482
7	60	3	2244	1963	2199	2291	2004	2246	2	502
8	68	3	2367	2061	2314	2414	2101	2361	2	522
9	76	4	2695	2320	2623	2758	2374	2687	2	381
• 10	84	4	2817	2418	2739	2880	2472	2802	3	824
11	96	4	2972	2542	2885	3035	2596	2948	3	844
12	104	4	3094	2640	3000	3157	2694	3063	3	864
13	112	4	3217	2737	3115	3280	2791	3179	3	884
14	120	5	3545	2997	3425	3624	3064	3504	3	743
15	128	5	3667	3094	3540	3746	3162	3619	3	763
16	136	5	3790	3192	3655	3868	3259	3734	3	783
17	144	5	3912	3290	3770	3991	3357	3849	3	803
18	152	5	4035	3387	3886	4113	3455	3965	3	823
^reduction per wall socket			434	435	451	450	449	467		
additional 3/4" between rods			without surcharge							

Notes

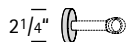

larger base plate + \$ 12.00 per bracket



* rings with plastic inserts

• rods in excess of 9ft. will be delivered in two sections



^ position wall socket left/right, please specify

components see page 384

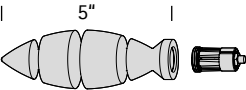
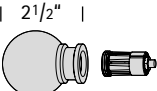
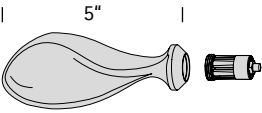
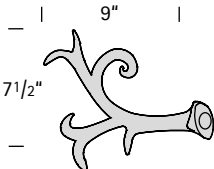
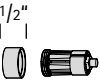
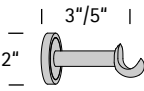
brass 3/4" dia.

components	part	part-no.	color-no.	price
	brass tube 3/4" dia. smooth	20610	51 anthracite	Cut to measure \$ / lin. ft. 26.40
			60 polished brass	22.00
			62 brushed brass	26.40
			72 brushed nickel	28.80
			80 antique bronzed	28.80
	brass tube 3/4" dia. fluted	20630	60 polished brass	Cut to measure \$ / lin. ft. 22.00
			80 antique bronzed	28.80
	finial Cosima	22901	62 brushed brass	184.60
			72 brushed nickel	221.80
			80 antique bronzed	221.80
			88 gold leaf patina	221.80
	finial Julia	22902	62 brushed brass	184.60
			72 brushed nickel	221.80
			80 antique bronzed	221.80
			88 gold leaf patina	221.80
	finial Aida	right	22903	62 brushed brass 184.60
			72 brushed nickel 221.80	
		left	22904	80 antique bronzed 221.80
			88 gold leaf patina 221.80	
	finial Hamlet	left	20945	67 brass patina 358.00
		right	20946	80 antique bronzed 335.50
	end cap	20729	51 anthracite	31.30
			60 polished brass	26.10
			62 brushed brass	31.30
			72 brushed nickel	33.30
			80 antique bronzed	33.30
	bracket for Julia, Aida, Cosima	3"	22911	51/62 anthracite/brushed brass 137.40
			51/72 anthracite/brushed nickel 149.80	
			51/86 anthracite/silver leaf 149.80	
			51/87 anthracite/gold leaf 149.80	
		5"	22912	72 brushed nickel 158.60
			72/87 brushed nickel/gold leaf 158.60	
			72/88 brushed nickel/gold leaf patina 158.60	
			80 antique bronzed 158.60	

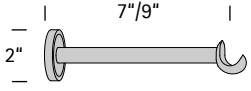
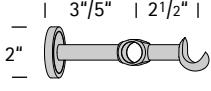
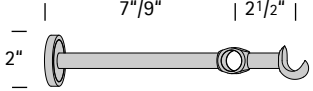
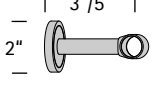
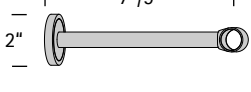
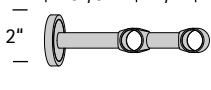
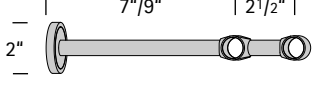
brass 3/4" dia.

components	part	part-no.	color-no.	price
	bracket for Julia, Aida, Cosima	7"	22913	51/62 anthracite/brushed brass 150.90
				51/72 anthracite/brushed nickel 163.30
				51/86 anthracite/silver leaf 163.30
		9"	22914	51/87 anthracite/gold leaf 163.30
				72 brushed nickel 174.30
				72/87 brushed nickel/gold leaf 174.30
				72/88 brushed nickel/gold leaf patina 174.30
				80 antique bronzed 174.30
	double bracket for Julia, Aida, Cosima	3"	22921	51/62 anthracite/brushed brass 208.10
				51/72 anthracite/brushed nickel 220.50
				51/86 anthracite/silver leaf 220.50
		5"	22922	51/87 anthracite/gold leaf 220.50
				72 brushed nickel 233.50
				72/87 brushed nickel/gold leaf 233.50
				72/88 brushed nickel/gold leaf patina 233.50
				80 antique bronzed 233.50
	double bracket for Julia, Aida, Cosima	7"	22923	51/62 anthracite/brushed brass 221.60
				51/72 anthracite/brushed nickel 234.00
				51/86 anthracite/silver leaf 234.00
		9"	22924	51/87 anthracite/gold leaf 234.00
				72 brushed nickel 249.20
				72/87 brushed nickel/gold leaf 249.20
				72/88 brushed nickel/gold leaf patina 249.20
				80 antique bronzed 249.20
	bracket for Hamlet also intermediate bracket for Silva	3"	20711	60 polished brass 102.70
				62 brushed brass 123.50
		5"	20712	72 brushed nickel 130.90
				80 antique bronzed 130.90
	bracket for Hamlet also intermediate bracket for Silva	7"	20713	60 polished brass 116.20
				62 brushed brass 139.30
		9"	20714	72 brushed nickel 146.60
				80 antique bronzed 146.60
	double bracket for Hamlet also intermediate bracket for Silva	3"	20721	60 polished brass 161.70
				62 brushed brass 194.20
		5"	20722	72 brushed nickel 205.80
				80 antique bronzed 205.80
	double bracket for Hamlet also intermediate bracket for Silva	7"	20723	60 polished brass 175.20
				62 brushed brass 210.00
		9"	20724	72 brushed nickel 221.50
				80 antique bronzed 221.50
	rosette Silva	20991	67 brass patina 168.90	
			80 antique bronzed 177.90	
			88 gold leaf patina 177.90	



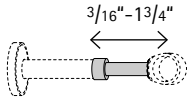
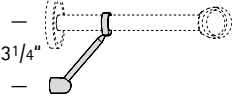
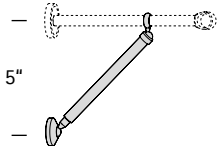
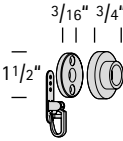
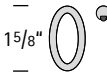
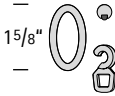
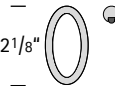

brass 3/4" dia.

components	part	part-no.	color-no.	price
	bracket for rosette Silva	3"	20771 60	polished brass 108.90
			62	brushed brass 130.70
		5"	20772 72	brushed nickel 138.70
			80	antique bronzed 138.70
	bracket for rosette Silva	7"	20773 60	polished brass 122.40
			62	brushed brass 146.50
		9"	20774 72	brushed nickel 154.40
			80	antique bronzed 154.40
	double bracket for rosette Silva	3"	20781 60	polished brass 167.90
			62	brushed brass 201.40
		5"	20782 72	brushed nickel 213.60
			80	antique bronzed 213.60
	double bracket for rosette Silva	7"	20783 60	polished brass 181.40
			62	brushed brass 217.20
		9"	20784 72	brushed nickel 229.30
			80	antique bronzed 229.30
	additional distance between rods for double rod e.g. 20721L	L		without surcharge
	larger base plate for all brackets e.g. 20711X	X		surcharge 14.00
	shorten bracket for all brackets e.g. 20712-62-S-4"	S		surcharge 43.00
	ceiling converter for ceiling mounts			see page 454

brass 3/4" dia.

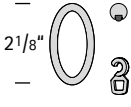
components	part	part-no.	color-no.	price
 <p>1" </p>	extension piece 1"	30719	51 anthracite	22.70
			60 polished brass	19.00
			62 brushed brass	22.70
			72 brushed nickel	24.10
			80 antique bronzed	24.10
 <p>3/16"-1 3/4"</p>	extension piece extendable	30619	51 anthracite	42.80
			60 polished brass	35.60
			62 brushed brass	42.80
			72 brushed nickel	45.20
			80 antique bronzed	45.20
 <p>3 1/4"</p>	bracket support light duty can be retrofitted	20617	51 anthracite	82.20
			60 polished brass	82.20
			62 brushed brass	100.20
			72 brushed nickel	100.20
			80 antique bronzed	100.20
 <p>5"</p>	bracket support can be retrofitted	30617	51 anthracite	216.60
			60 polished brass	180.70
			62 brushed brass	216.60
			72 brushed nickel	228.70
			80 antique bronzed	228.70
 <p>3/16" 3/4" 1 1/2"</p>	wall socket with anchor clip can be used at both ends	20705	51 anthracite	66.20
			60 polished brass	55.20
			62 brushed brass	66.20
			72 brushed nickel	70.30
			80 antique bronzed	70.30
 <p>1 5/8"</p>	ring 1 5/8" x 3/16" with plastic insert for Julia, Aida, Cosima, Silva	20709	51 anthracite	5.70
			60 polished brass	5.10
			62 brushed brass	5.70
			72 brushed nickel	5.90
			80 antique bronzed	5.90
 <p>1 5/8"</p>	ring 1 5/8" x 3/16" with eyelet clip with plastic insert for Julia, Aida, Cosima, Silva	20708	51 anthracite	5.90
			60 polished brass	5.30
			62 brushed brass	5.90
			72 brushed nickel	6.10
			80 antique bronzed	6.10
 <p>2 1/8"</p>	ring 2 1/8" x 3/16" with plastic insert for Hamlet	30709	51 anthracite	7.60
			60 polished brass	6.50
			62 brushed brass	7.60
			72 brushed nickel	7.90
			80 antique bronzed	7.90

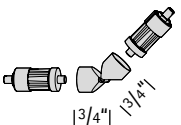
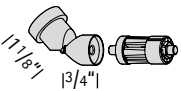
brass 3/4" dia.

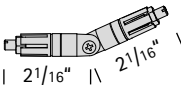
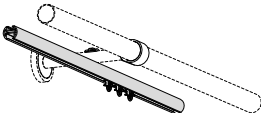
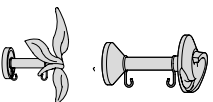
components	part	part-no.	color-no.	price
	ring 2 1/8" x 3/16" with eyelet clip with plastic insert for Hamlet	30708	51 anthracite	7.80
			60 polished brass	6.70
			62 brushed brass	7.80
			72 brushed nickel	8.10
			80 antique bronzed	8.10
	eyelet clip	10925	50 white	0.20
	elbow 90° any angle cut to measure from 90° to 160° surcharge \$ 56.00 not for fluted tube	20650	51 anthracite	148.60
			60 polished brass	123.90
			62 brushed brass	148.60
			72 brushed nickel	157.40
			80 antique bronzed	157.40
	swivel joint not for fluted tube	20651	51 anthracite	123.90
			60 polished brass	111.40
			62 brushed brass	133.70
			72 brushed nickel	141.90
			80 antique bronzed	141.90
	wall socket for sloping ceilings one side only not for fluted tube	20652	51 anthracite	156.40
			60 polished brass	138.40
			62 brushed brass	166.20
			72 brushed nickel	176.30
			80 antique bronzed	176.30
	tube connector	for smooth tube 20659	99	18.60
		for fluted tube 20658	99	18.60
	mitre connector for any angle not for fluted tube mitre cut \$ 43.00	20653	99	87.80
	traversing rod and accessories for extra run	see page 455		
	accessories	see page 443		

page 390

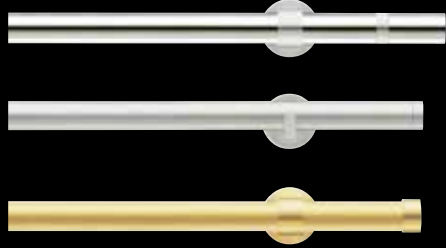

page 394

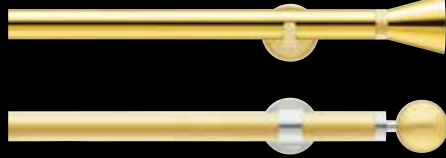

page 398

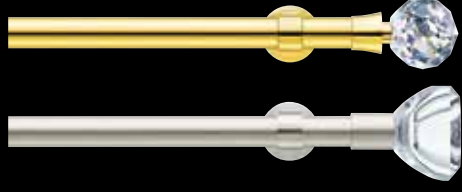

page 402

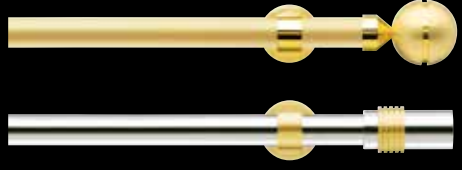

brass

1" dia.



polo brushed nickel/polished nickel



derby brushed brass/brushed nickel



golf polished brass



holdback brushed brass/polished brass p. 444

finishes available

60 polished brass

62 brushed brass

71 polished nickel

72 brushed nickel

polo 71/72 polished nickel/brushed nickel



cup 72 brushed nickel



match 62 brushed brass



scale 1:1

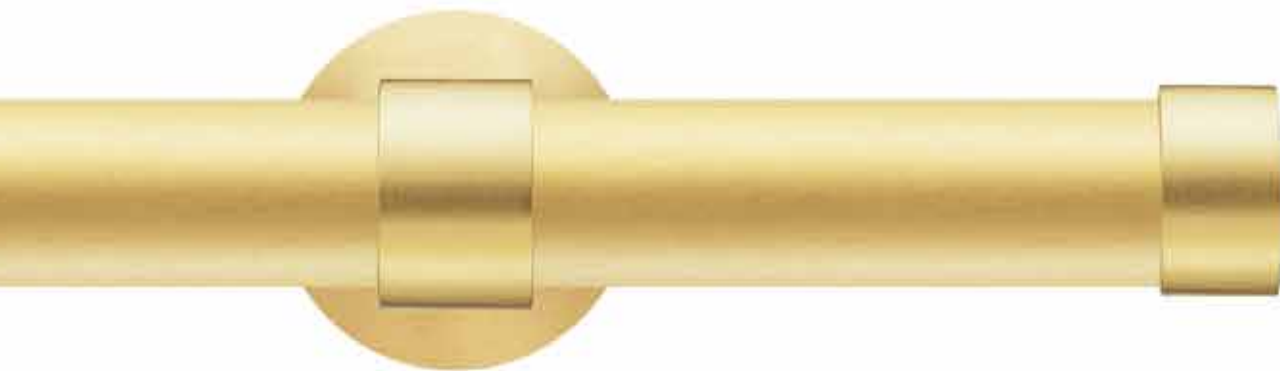
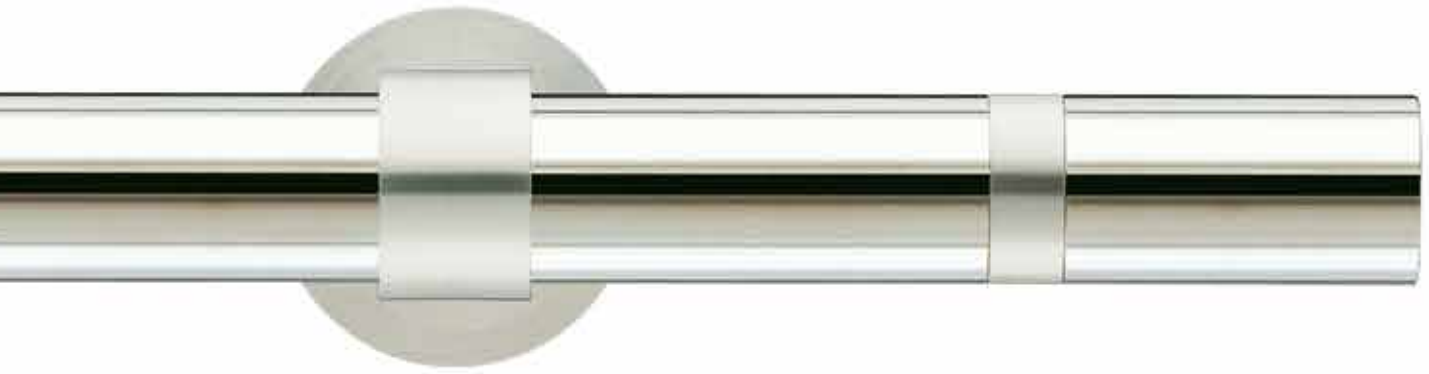

brass 1" dia.

finishes available

- A 60 polished brass
- B 62 brushed brass
- 71 polished nickel
- C 72 brushed nickel

also in combination

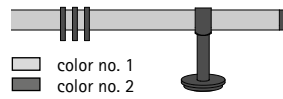

e.g. 60/71 polished brass/polished nickel
price: B 71 polished nickel
(higher value price group)

single rod

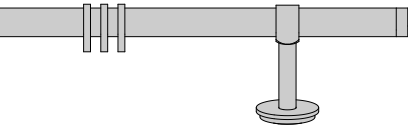

length →

Cup

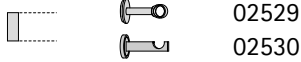

Match

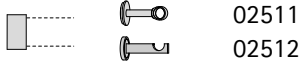

length (ft.)	* rings	brackets		brackets 3" or 5"			brackets 7" or 9"			integral	
				A	B	C	A	B	C	brackets	surcharge
3	14	2	\$	481	572	608	508	604	640	2	334
4	18	2		537	639	679	564	670	711	2	346
5	22	2		594	705	751	621	737	782	2	358
6	26	3		756	898	956	796	946	1003	2	265
7	30	3		812	965	1027	853	1012	1074	2	277
8	34	3		869	1031	1098	909	1079	1145	2	289
9	38	3		925	1098	1169	966	1145	1217	2	301
• 10	42	3		982	1164	1241	1022	1212	1288	3	567
11	48	4		1158	1374	1463	1212	1437	1526	3	474
12	52	4		1214	1441	1534	1268	1504	1597	3	486
13	56	4		1271	1507	1606	1325	1570	1668	3	498
14	60	4		1327	1574	1677	1381	1637	1739	3	510
15	64	4		1384	1640	1748	1438	1703	1811	3	522
16	68	4		1440	1707	1819	1494	1770	1882	3	534
17	72	5		1602	1900	2024	1670	1979	2103	3	440
18	76	5		1659	1966	2096	1726	2045	2174	3	452
reduction per wall socket				86	104	110	100	120	126		

double rod

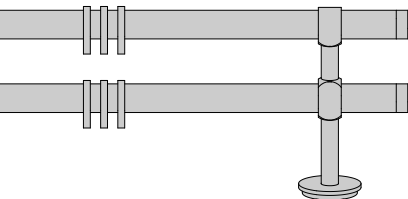

length →

Cup

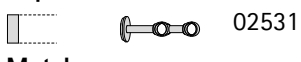

Match

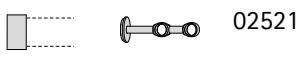

length (ft.)	* rings	brackets		brackets 3" or 5"			brackets 7" or 9"			integral	
				A	B	C	A	B	C	brackets	surcharge
3	28	2	\$	870	1035	1100	897	1067	1132	2	640
4	36	2		983	1168	1242	1010	1200	1274	2	664
5	44	2		1096	1301	1385	1123	1333	1416	2	688
6	52	3		1375	1633	1738	1415	1680	1785	2	546
7	60	3		1488	1766	1880	1528	1813	1927	2	570
8	68	3		1601	1899	2022	1641	1946	2069	2	594
9	76	3		1714	2032	2164	1754	2079	2211	2	618
• 10	84	3		1827	2165	2306	1867	2212	2354	3	1092
11	96	4		2134	2530	2694	2188	2593	2757	3	950
12	104	4		2247	2663	2836	2301	2726	2899	3	974
13	112	4		2360	2796	2978	2414	2859	3041	3	998
14	120	4		2473	2929	3120	2527	2992	3183	3	1022
15	128	4		2586	3062	3263	2640	3125	3325	3	1046
16	136	4		2699	3195	3405	2753	3258	3468	3	1070
17	144	5		2978	3527	3758	3045	3606	3836	3	929
18	152	5		3091	3660	3900	3158	3739	3979	3	953
reduction per wall socket				127	153	162	141	169	178		
additional 3/4" between rods				without surcharge							

Notes

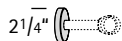

larger base plate + \$ 14.00 per bracket (not for flat brackets)

* rings with plastic insert

• rods in excess of 9ft. will be delivered in two sections
accessories see page 443



brass 1" dia.

finishes available

- A 60 polished brass
- B 62 brushed brass
- 71 polished nickel
- C 72 brushed nickel

also in combination

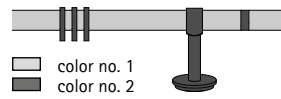

e.g. 60/71 polished brass/pol. nickel
price: B 71 polished nickel
(higher value price group)

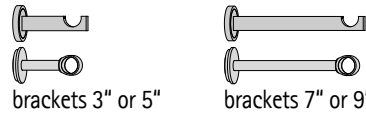

single rod

length (ft.)	*rings	brackets		brackets 3" or 5"			brackets 7" or 9"			integral brackets surcharge	
				A	B	C	A	B	C		
3	14	2	\$	607	724	769	634	755	800	2	334
4	18	2		663	790	840	690	822	871	2	346
5	22	2		720	857	911	747	888	942	2	358
6	26	3		882	1050	1117	922	1097	1164	2	265
7	30	3		938	1116	1188	979	1164	1235	2	277
8	34	3		995	1183	1259	1035	1230	1306	2	289
9	38	3		1051	1249	1330	1092	1297	1377	2	301
10	42	3	•	1108	1316	1401	1148	1363	1448	3	567
11	48	4		1284	1526	1624	1338	1589	1687	3	474
12	52	4		1340	1592	1695	1394	1655	1758	3	486
13	56	4		1397	1659	1766	1451	1722	1829	3	498
14	60	4		1453	1725	1837	1507	1788	1900	3	510
15	64	4		1510	1792	1908	1564	1855	1971	3	522
16	68	4		1566	1858	1979	1620	1921	2042	3	534
17	72	5		1728	2051	2185	1796	2130	2263	3	440
18	76	5		1785	2118	2256	1852	2197	2334	3	452
			reduction per wall socket	149	179	190	163	195	206		

double rod

length (ft.)	*rings	brackets		brackets 3" or 5"			brackets 7" or 9"			integral brackets surcharge	
				A	B	C	A	B	C		
3	28	2	\$	996	1186	1261	1023	1218	1292	2	640
4	36	2		1109	1319	1403	1136	1351	1434	2	664
5	44	2		1222	1452	1545	1249	1484	1576	2	688
6	52	3		1501	1784	1898	1541	1832	1945	2	546
7	60	3		1614	1917	2040	1654	1965	2087	2	570
8	68	3		1727	2050	2182	1767	2098	2230	2	594
9	76	3		1840	2183	2325	1880	2231	2372	2	618
10	84	3	•	1953	2316	2467	1993	2364	2514	3	1092
11	96	4		2260	2681	2854	2314	2744	2917	3	950
12	104	4		2373	2814	2996	2427	2877	3059	3	974
13	112	4		2486	2947	3139	2540	3010	3201	3	998
14	120	4		2599	3080	3281	2653	3143	3344	3	1022
15	128	4		2712	3213	3423	2766	3276	3486	3	1046
16	136	4		2825	3346	3565	2879	3409	3628	3	1070
17	144	5		3104	3678	3918	3171	3757	3997	3	929
18	152	5		3217	3811	4060	3284	3890	4139	3	953
			reduction per wall socket	190	229	242	204	244	258		
			additional 3/4" between rods								

Notes

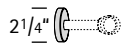

larger base plate

+ \$ 14.00 per bracket (not for flat brackets)

* rings with plastic insert

• rods in excess of 9ft. will be delivered in two sections

accessories

see page 443



components see page 406

finishes available

60 polished brass

62 brushed brass

71 polished nickel

72 brushed nickel

derby 60/62 polished brass/brushed brass



golf 62/72 brushed brass/brushed nickel

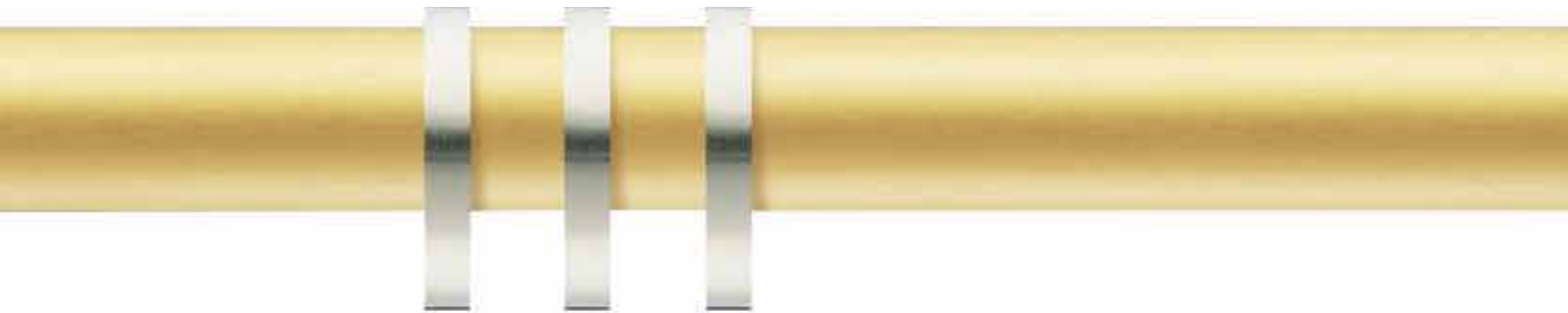

scale 1:1

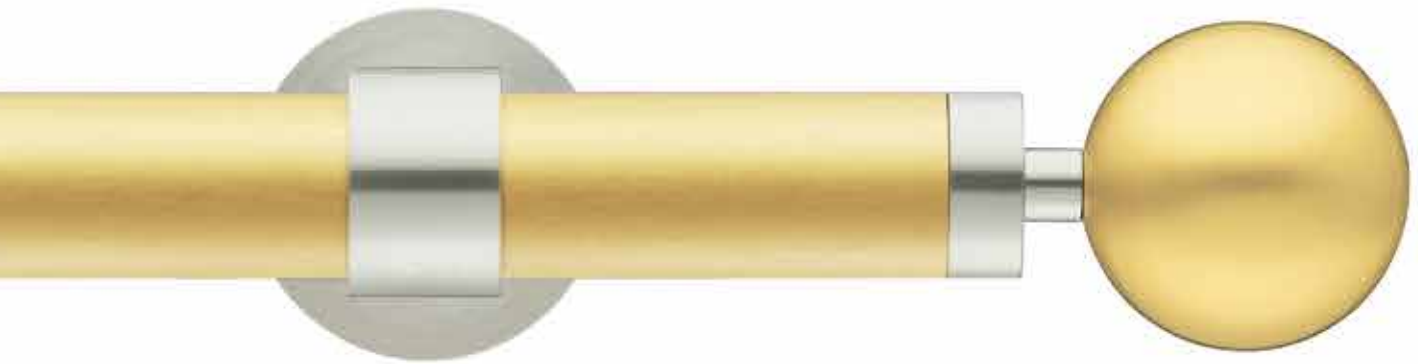

brass 1" dia.

finishes available

- A 60 polished brass
- B 62 brushed brass
- 71 polished nickel
- C 72 brushed nickel

also in combination

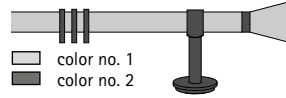

e.g. 60/71 polished brass/polished nickel
price: B 71 polished nickel
(higher value price group)

single rod

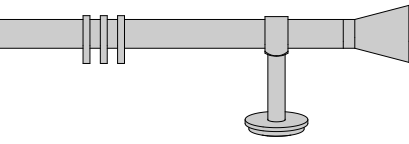

length →

set-no.

Derby

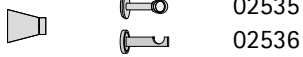

Golf

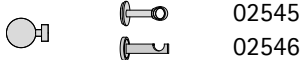

length (ft.)	* rings	brackets		brackets 3" or 5"			brackets 7" or 9"			integral	
				A	B	C	A	B	C	brackets	surcharge
3	14	2	\$	656	783	832	683	815	863	2	334
4	18	2		713	849	903	740	881	934	2	346
5	22	2		769	916	974	796	948	1006	2	358
6	26	3		931	1109	1180	972	1157	1227	2	265
7	30	3		988	1176	1251	1028	1223	1298	2	277
8	34	3		1044	1242	1322	1085	1290	1369	2	289
9	38	3		1101	1309	1393	1141	1356	1440	2	301
• 10	42	3		1157	1375	1464	1198	1423	1511	3	567
11	48	4		1334	1585	1687	1388	1648	1750	3	474
12	52	4		1390	1651	1758	1444	1715	1821	3	486
13	56	4		1447	1718	1829	1501	1781	1892	3	498
14	60	4		1503	1784	1900	1557	1848	1963	3	510
15	64	4		1560	1851	1971	1614	1914	2034	3	522
16	68	4		1616	1917	2042	1670	1981	2105	3	534
17	72	5		1778	2111	2248	1846	2190	2327	3	440
18	76	5		1835	2177	2319	1902	2256	2398	3	452
reduction per wall socket				174	209	222	188	225	238		

double rod

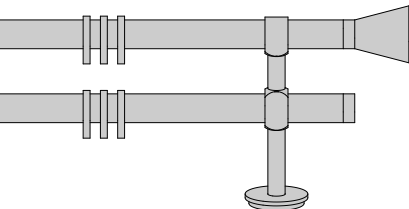

length →

set-no.

Derby

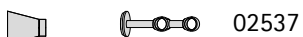

Golf

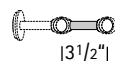
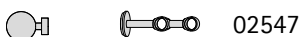

length (ft.)	* rings	brackets		brackets 3" or 5"			brackets 7" or 9"			integral	
				A	B	C	A	B	C	brackets	surcharge
3	28	2	\$	1046	1246	1324	1073	1277	1355	2	640
4	36	2		1159	1379	1466	1186	1410	1497	2	664
5	44	2		1272	1512	1608	1299	1543	1640	2	688
6	52	3		1550	1844	1961	1591	1891	2008	2	546
7	60	3		1663	1977	2103	1704	2024	2151	2	570
8	68	3		1776	2110	2246	1817	2157	2293	2	594
9	76	3		1889	2243	2388	1930	2290	2435	2	618
• 10	84	3		2002	2376	2530	2043	2423	2577	3	1092
11	96	4		2310	2741	2917	2364	2804	2980	3	950
12	104	4		2423	2874	3060	2477	2937	3122	3	974
13	112	4		2536	3007	3202	2590	3070	3265	3	998
14	120	4		2649	3140	3344	2703	3203	3407	3	1022
15	128	4		2762	3273	3486	2816	3336	3549	3	1046
16	136	4		2875	3406	3628	2929	3469	3691	3	1070
17	144	5		3153	3737	3981	3221	3816	4060	3	929
18	152	5		3266	3870	4124	3334	3949	4202	3	953
reduction per wall socket				215	258	274	229	274	290		
additional 3/4" between rods				without surcharge							

Notes

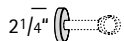

larger base plate + \$ 14.00 per bracket (not for flat brackets)

* rings with plastic insert

- rods in excess of 9ft. will be delivered in two sections
- accessories see page 443





crystal polished brass/crystal glass hand cut



globus polished brass/brushed brass



facette polished nickel/crystal glass



holdback brushed brass p. 447



finishes available

60 polished brass

62 brushed brass

71 polished nickel

72 brushed nickel

crystal 60/98 polished brass/crystal glass hand cut



facette 72/92 brushed nickel/crystal glass



scale 1:1



brass 1" dia.

finishes available

- A 60/98 polished brass/crystal glass hand cut
- B 62/98 brushed brass/crystal glass hand cut
- 71/98 polished nickel/crystal glass hand cut
- C 72/98 brushed nickel/crystal glass hand cut

single rod

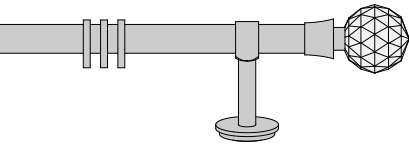

length → 3 3/4" |

Crystal set-no.

 bracket closed 02570

 bracket flat 02571

length (ft.)	* rings	brackets		brackets 3" or 5"			brackets 7" or 9"			integral	
				A	B	C	A	B	C	brackets	surcharge
3	14	2	\$	978	1075	1113	1005	1107	1145	2	334
4	18	2		1035	1142	1184	1062	1173	1216	2	346
5	22	2		1091	1208	1256	1118	1240	1287	2	358
6	26	3		1253	1401	1461	1294	1449	1508	2	265
7	30	3		1310	1468	1532	1350	1515	1579	2	277
8	34	3		1366	1534	1603	1407	1582	1650	2	289
9	38	3		1423	1601	1674	1463	1648	1722	2	301
• 10	42	3		1479	1667	1746	1520	1715	1793	3	567
11	48	4		1656	1877	1968	1710	1940	2031	3	474
12	52	4		1712	1944	2039	1766	2007	2102	3	486
13	56	4		1769	2010	2111	1823	2073	2173	3	498
14	60	4		1825	2077	2182	1879	2140	2244	3	510
15	64	4		1882	2143	2253	1936	2206	2316	3	522
16	68	4		1938	2210	2324	1992	2273	2387	3	534
17	72	5		2100	2403	2529	2168	2482	2608	3	440
18	76	5		2157	2469	2601	2224	2548	2679	3	452
reduction per wall socket				335	355	363	349	371	378		

double rod

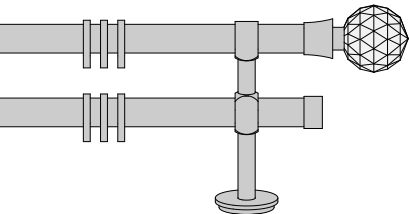

length → 3 3/4" |

Crystal set-no.

 bracket closed 02572

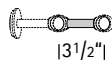

length (ft.)	* rings	brackets		brackets 3" or 5"			brackets 7" or 9"			integral	
				A	B	C	A	B	C	brackets	surcharge
3	28	2	\$	1368	1538	1605	1395	1570	1637	2	640
4	36	2		1481	1671	1747	1508	1703	1779	2	664
5	44	2		1594	1804	1890	1621	1836	1921	2	688
6	52	3		1872	2136	2243	1913	2183	2290	2	546
7	60	3		1985	2269	2385	2026	2316	2432	2	570
8	68	3		2098	2402	2527	2139	2449	2574	2	594
9	76	3		2211	2535	2669	2252	2582	2716	2	618
• 10	84	3		2324	2668	2811	2365	2715	2859	3	1092
11	96	4		2632	3033	3199	2686	3096	3262	3	950
12	104	4		2745	3166	3341	2799	3229	3404	3	974
13	112	4		2858	3299	3483	2912	3362	3546	3	998
14	120	4		2971	3432	3625	3025	3495	3688	3	1022
15	128	4		3084	3565	3768	3138	3628	3830	3	1046
16	136	4		3197	3698	3910	3251	3761	3973	3	1070
17	144	5		3475	4030	4263	3543	4109	4341	3	929
18	152	5		3588	4163	4405	3656	4242	4484	3	953
reduction per wall socket				376	404	415	390	420	430		
additional 3/4" between rods				without surcharge							

Notes

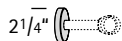

larger base plate + \$ 14.00 per bracket (not for flat brackets)

* rings with plastic insert

• rods in excess of 9ft. will be delivered in two sections

accessories

see page 443



brass 1" dia.

finishes available

- A 60/92 polished brass/crystal glass
- B 62/92 brushed brass/crystal glass
- 71/92 polished nickel/crystal glass
- C 72/92 brushed nickel/crystal glass

single rod

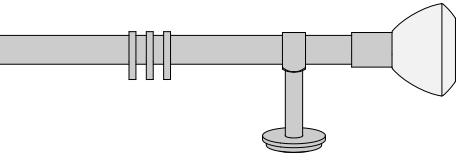

length → 3 1/4" |

Facette set-no.

 bracket closed 02579

 bracket flat 02580

length (ft.)	*rings	brackets	brackets 3" or 5"			brackets 7" or 9"			integral	
			A	B	C	A	B	C	brackets	surcharge
3	14	2	\$ 782	875	911	809	906	943	2	334
4	18	2	839	941	982	866	973	1014	2	346
5	22	2	895	1008	1053	922	1039	1085	2	358
6	26	3	1057	1201	1259	1098	1248	1306	2	265
7	30	3	1114	1267	1330	1154	1315	1377	2	277
8	34	3	1170	1334	1401	1211	1381	1448	2	289
9	38	3	1227	1400	1472	1267	1448	1519	2	301
• 10	42	3	1283	1467	1543	1324	1514	1590	3	567
11	48	4	1460	1677	1766	1514	1740	1829	3	474
12	52	4	1516	1743	1837	1570	1806	1900	3	486
13	56	4	1573	1810	1908	1627	1873	1971	3	498
14	60	4	1629	1876	1979	1683	1939	2042	3	510
15	64	4	1686	1943	2051	1740	2006	2113	3	522
16	68	4	1742	2009	2122	1796	2072	2184	3	534
17	72	5	1904	2202	2327	1972	2281	2406	3	440
18	76	5	1961	2269	2398	2028	2348	2477	3	452
reduction per wall socket			237	255	262	251	271	277		

double rod

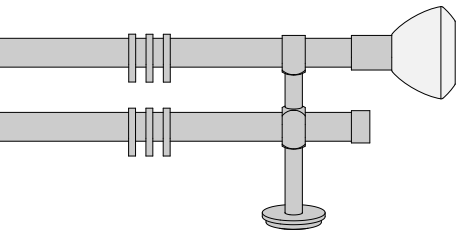

length → 3 1/4" |

Facette set-no.

 bracket closed 02581

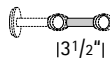

length (ft.)	*rings	brackets	brackets 3" or 5"			brackets 7" or 9"			integral	
			A	B	C	A	B	C	brackets	surcharge
3	28	2	\$ 1172	1338	1403	1199	1369	1434	2	640
4	36	2	1285	1471	1545	1312	1502	1577	2	664
5	44	2	1398	1604	1687	1425	1635	1719	2	688
6	52	3	1676	1935	2040	1717	1983	2088	2	546
7	60	3	1789	2068	2183	1830	2116	2230	2	570
8	68	3	1902	2201	2325	1943	2249	2372	2	594
9	76	3	2015	2334	2467	2056	2382	2514	2	618
• 10	84	3	2128	2467	2609	2169	2515	2656	3	1092
11	96	4	2436	2832	2997	2490	2896	3059	3	950
12	104	4	2549	2965	3139	2603	3029	3202	3	974
13	112	4	2662	3098	3281	2716	3162	3344	3	998
14	120	4	2775	3231	3423	2829	3295	3486	3	1022
15	128	4	2888	3364	3565	2942	3428	3628	3	1046
16	136	4	3001	3497	3708	3055	3561	3770	3	1070
17	144	5	3279	3829	4061	3347	3908	4139	3	929
18	152	5	3392	3962	4203	3460	4041	4281	3	953
reduction per wall socket			278	304	313	292	320	329		
additional 3/4" between rods			without surcharge							

Notes

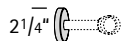

larger base plate + \$ 14.00 per bracket (not for flat brackets)

* rings with plastic insert

• rods in excess of 9ft. will be delivered in two sections

accessories

see page 443

components see page 406

finishes available

60 polished brass

62 brushed brass

71 polished nickel

72 brushed nickel

globus 62/60 brushed brass/polished brass



focus 71/62 polished nickel/brushed brass



scale 1:1



brass 1" dia.

finishes available

- A 60 polished brass
- B 62 brushed brass
71 polished nickel
- C 72 brushed nickel

also in combination

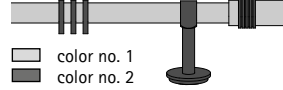

e.g. 60/71 polished brass/polished nickel
price: B 71 polished nickel
(higher value price group)

single rod

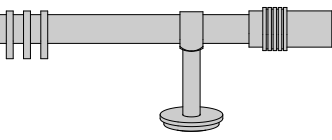

length \rightarrow $2\frac{3}{4}$ "

Focus set-no.

bracket closed 02549

bracket flat 02550

length * rings brackets

(ft.)			
3	14	2	
4	18	2	
5	22	2	
6	26	3	
7	30	3	
8	34	3	
9	38	3	
10	42	3	
11	48	4	
12	52	4	
13	56	4	
14	60	4	
15	64	4	
16	68	4	
17	72	5	
18	76	5	
reduction per wall socket			



brackets 3" or 5"

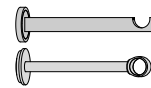

brackets 7" or 9"



integral

brackets surcharge

	A	B	C	A	B	C		
\$	616	734	781	643	766	812	2	334
	672	801	852	699	832	883	2	346
	729	867	923	756	899	954	2	358
	891	1060	1128	931	1108	1175	2	265
	947	1127	1199	988	1174	1247	2	277
	1004	1193	1271	1044	1241	1318	2	289
	1060	1260	1342	1101	1307	1389	2	301
	1117	1326	1413	1157	1374	1460	3	567
	1293	1536	1636	1347	1599	1698	3	474
	1349	1603	1707	1403	1666	1769	3	486
	1406	1669	1778	1460	1732	1841	3	498
	1462	1736	1849	1516	1799	1912	3	510
	1519	1802	1920	1573	1865	1983	3	522
	1575	1869	1991	1629	1932	2054	3	534
	1737	2062	2197	1805	2141	2275	3	440
	1794	2128	2268	1861	2207	2346	3	452
	154	185	196	167	201	212		

double rod

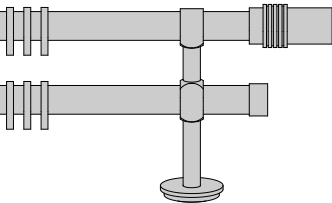

length \rightarrow $2\frac{3}{4}$ "

Focus set-no.

bracket closed 02551

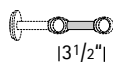

length * rings brackets

(ft.)			
3	28	2	
4	36	2	
5	44	2	
6	52	3	
7	60	3	
8	68	3	
9	76	3	
10	84	3	
11	96	4	
12	104	4	
13	112	4	
14	120	4	
15	128	4	
16	136	4	
17	144	5	
18	152	5	
reduction per wall socket			
additional $\frac{3}{4}$ " between rods			

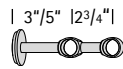

brackets 3" or 5"

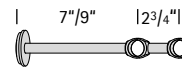

brackets 7" or 9"



integral

brackets surcharge

	A	B	C	A	B	C		
\$	1005	1197	1272	1032	1229	1304	2	640
	1118	1330	1415	1145	1362	1446	2	664
	1231	1463	1557	1258	1495	1588	2	688
	1510	1795	1910	1550	1842	1957	2	546
	1623	1928	2052	1663	1975	2099	2	570
	1736	2061	2194	1776	2108	2241	2	594
	1849	2194	2336	1889	2241	2384	2	618
	1962	2327	2479	2002	2374	2526	3	1092
	2269	2692	2866	2323	2755	2929	3	950
	2382	2825	3008	2436	2888	3071	3	974
	2495	2958	3150	2549	3021	3213	3	998
	2608	3091	3293	2662	3154	3355	3	1022
	2721	3224	3435	2775	3287	3498	3	1046
	2834	3357	3577	2888	3420	3640	3	1070
	3113	3689	3930	3180	3768	4009	3	929
	3226	3822	4072	3293	3901	4151	3	953
	195	234	248	208	250	264		

Notes

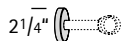

larger base plate

+ \$ 14.00 per bracket (not for flat brackets)

* rings with plastic insert

• rods in excess of 9ft. will be delivered in two sections

accessories

see page 443



brass 1" dia.

finishes available

- A 60 polished brass
- B 62 brushed brass
- 71 polished nickel
- C 72 brushed nickel

also in combination

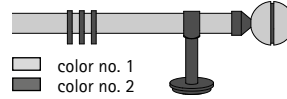

e.g. 60/71 polished brass/pol. nickel
price: B 71 polished nickel
(higher value price group)

single rod

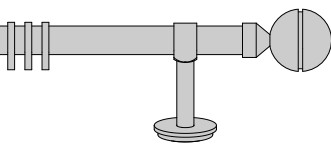

length → 3" |

Globus set-no.

bracket closed 02539

bracket flat 02540

length (ft.)	*rings	brackets	brackets 3" or 5"			brackets 7" or 9"			integral brackets surcharge	
			A	B	C	A	B	C		
3	14	2	\$ 733	875	929	760	906	960	2	334
4	18	2	789	941	1000	816	973	1031	2	346
5	22	2	846	1008	1071	873	1039	1103	2	358
6	26	3	1008	1201	1277	1048	1248	1324	2	265
7	30	3	1064	1267	1348	1105	1315	1395	2	277
8	34	3	1121	1334	1419	1161	1381	1466	2	289
9	38	3	1177	1400	1490	1218	1448	1537	2	301
10	42	3	1234	1467	1561	1274	1514	1608	3	567
11	48	4	1410	1677	1784	1464	1740	1847	3	474
12	52	4	1467	1743	1855	1521	1806	1918	3	486
13	56	4	1523	1810	1926	1577	1873	1989	3	498
14	60	4	1580	1876	1997	1634	1939	2060	3	510
15	64	4	1636	1943	2068	1690	2006	2131	3	522
16	68	4	1693	2009	2139	1747	2072	2202	3	534
17	72	5	1855	2202	2345	1922	2281	2424	3	440
18	76	5	1911	2269	2416	1979	2348	2495	3	452
reduction per wall socket			213	255	270	226	271	286		

double rod

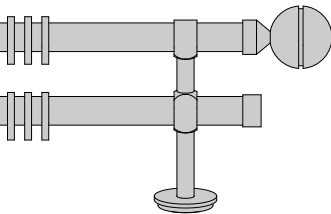

length → 3" |

Globus set-no.

bracket closed 02541

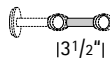

length (ft.)	*rings	brackets	brackets 3" or 5"			brackets 7" or 9"			integral brackets surcharge	
			A	B	C	A	B	C		
3	28	2	\$ 1122	1338	1421	1149	1369	1452	2	640
4	36	2	1235	1471	1563	1262	1502	1594	2	664
5	44	2	1348	1604	1705	1375	1635	1737	2	688
6	52	3	1627	1935	2058	1668	1983	2105	2	546
7	60	3	1740	2068	2200	1781	2116	2248	2	570
8	68	3	1853	2201	2343	1894	2249	2390	2	594
9	76	3	1966	2334	2485	2007	2382	2532	2	618
10	84	3	2079	2467	2627	2120	2515	2674	3	1092
11	96	4	2386	2832	3014	2440	2896	3077	3	950
12	104	4	2499	2965	3157	2553	3029	3219	3	974
13	112	4	2612	3098	3299	2666	3162	3362	3	998
14	120	4	2725	3231	3441	2779	3295	3504	3	1022
15	128	4	2838	3364	3583	2892	3428	3646	3	1046
16	136	4	2951	3497	3725	3005	3561	3788	3	1070
17	144	5	3230	3829	4078	3298	3908	4157	3	929
18	152	5	3343	3962	4221	3411	4041	4299	3	953
reduction per wall socket			254	304	322	267	320	338		
additional 3/4" between rods			without surcharge							

Notes

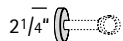

larger base plate + \$ 14.00 per bracket (not for flat brackets)

* rings with plastic insert

• rods in excess of 9ft. will be delivered in two sections

accessories

see page 443

components see page 406

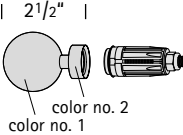
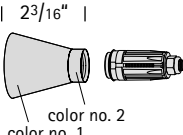
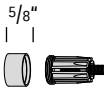
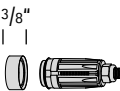
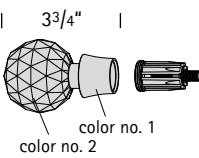
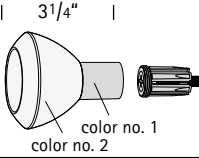
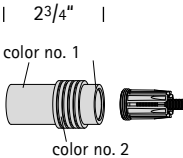
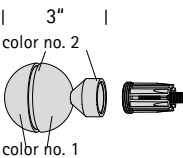

brass 1" dia.

components	part	part-no.	color no.	price
	brass tube 1" dia.	25610	60 polished brass 62 brushed brass 71 polished nickel 72 brushed nickel	Cut to measure \$/lin. ft. 27.70 33.30 33.30 36.70
	finial Polo	25971	60 polished brass 62 brushed brass 71 polished nickel 72 brushed nickel also in combination, e.g. 60/71 polished brass/polished nickel	105.80 127.00 127.00 134.60
	finial Golf	25972	60 polished brass 62 brushed brass 71 polished nickel 72 brushed nickel also in combination, e.g. 60/71 polished brass/polished nickel	130.60 156.70 156.70 166.20
	finial Derby	25973	60 polished brass 62 brushed brass 71 polished nickel 72 brushed nickel also in combination, e.g. 60/71 polished brass/polished nickel	130.60 156.70 156.70 166.20
	end cap Match	25729	60 polished brass 62 brushed brass 71 polished nickel 72 brushed nickel	42.80 51.30 51.30 54.40
	end cap Cup	25629	60 polished brass 62 brushed brass 71 polished nickel 72 brushed nickel	42.80 51.30 51.30 54.40
	finial Crystal	25702	60/98 polished brass/crystal glass hand cut 62/98 brushed brass/crystal glass hand cut 71/98 polished nickel/crystal glass hand cut 72/98 brushed nickel/crystal glass hand cut	291.60 302.80 302.80 306.90
	finial Facette	25704	60/92 polished brass/crystal glass 62/92 brushed brass/crystal glass 71/92 polished nickel/crystal glass 72/92 brushed nickel/crystal glass	193.60 202.60 202.60 205.80
	finial Focus	25902	60 polished brass 62 brushed brass 71 polished nickel 72 brushed nickel also in combination, e.g. 60/71 polished brass/polished nickel	110.30 132.30 132.30 140.50
	finial Globus	25803	60 polished brass 62 brushed brass 71 polished nickel 72 brushed nickel also in combination, e.g. 60/71 polished brass/polished nickel	168.90 202.60 202.60 214.70

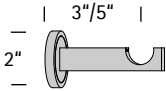
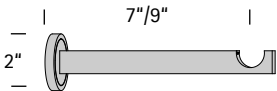
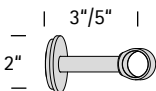
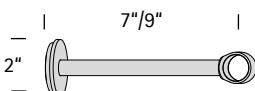
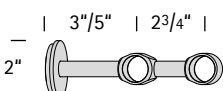
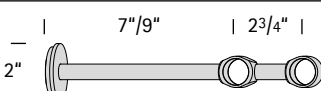
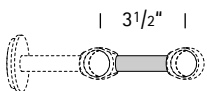
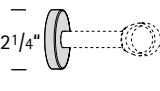
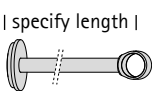
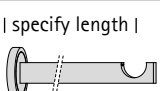
brass 1" dia.

components	part	part-no.	color-no.	price
	bracket flat	3"	25631	60 polished brass 105.50
				62 brushed brass 126.70
				71 polished nickel 126.70
		5"	25632	72 brushed nickel 134.50
	bracket flat	7"	25633	60 polished brass 119.00
				62 brushed brass 142.50
				71 polished nickel 142.50
		9"	25634	72 brushed nickel 150.20
	bracket closed	3"	25611	60 polished brass 105.50
				62 brushed brass 126.70
				71 polished nickel 126.70
		5"	25612	72 brushed nickel 134.50
	bracket closed	7"	25613	60 polished brass 119.00
				62 brushed brass 142.50
				71 polished nickel 142.50
		9"	25614	72 brushed nickel 150.20
	double bracket closed	3"	25621	60 polished brass 165.60
				62 brushed brass 198.80
				71 polished nickel 198.80
		5"	25622	72 brushed nickel 210.80
	double bracket closed	7"	25623	60 polished brass 179.10
				62 brushed brass 214.60
				71 polished nickel 214.60
		9"	25624	72 brushed nickel 226.50
	additional distance between rods for double rod e.g. 25623L	L		without surcharge
	larger base plate for brackets 25611 - 25624 e.g. 25612X not for flat brackets	X		surcharge 14.00
	shorten bracket e.g. 25612-71-S-4"	S		surcharge 43.00
	shorten bracket e.g. 25632-72-S-4"	S		surcharge 64.00

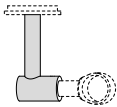
brass 1" dia.

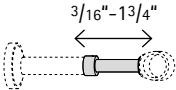
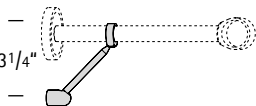
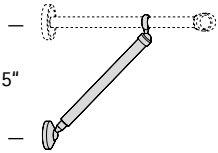
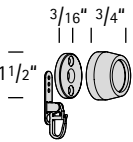
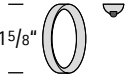
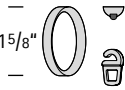
components	part	part-no.	color-no.	price	
	ceiling converter for ceiling mounts not for flat brackets		see page 454		
	extension piece 1" for brackets 25611 - 25624	30719	60 62 71 72	polished brass brushed brass polished nickel brushed nickel	19.00 22.70 22.70 24.10
	extension piece extendable for brackets 25611 - 25624	30619	60 62 71 72	polished brass brushed brass polished nickel brushed nickel	35.60 42.80 42.80 45.20
	bracket support light duty for brackets 25611 - 25624 can be retrofitted	20617	60 62 71 72	polished brass brushed brass polished nickel brushed nickel	82.20 100.20 100.20 100.20
	bracket support for brackets 25611 - 25624 can be retrofitted	30617	60 62 71 72	polished brass brushed brass polished nickel brushed nickel	180.70 216.60 216.60 228.70
	wall socket with anchor clip can be used at both ends	25705	60 62 71 72	polished brass brushed brass polished nickel brushed nickel	61.90 74.30 74.30 78.80
	ring 1⁵/₈" x 1/4" with plastic insert	25709	60 62 71 72	polished brass brushed brass polished nickel brushed nickel	7.00 8.10 8.10 8.40
	ring 1⁵/₈" x 1/4" with eyelet clip with plastic insert	25708	60 62 71 72	polished brass brushed brass polished nickel brushed nickel	7.20 8.30 8.30 8.60

brass 1" dia.

components	part	part-no.	color-no.	price
	eyelet clip	10921	50 white	0.20

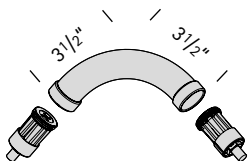

elbow 90° any angle cut to measure from 90° to 160° surcharge \$ 56.00	25650	60	polished brass	135.10
		62	brushed brass	162.10
		71	polished nickel	162.10
		72	brushed nickel	171.70

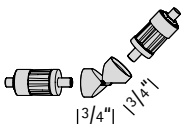

swivel joint	25651	60	polished brass	118.20
		62	brushed brass	141.90
		71	polished nickel	141.90
		72	brushed nickel	150.30

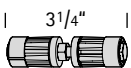

tube connector	25659	99		20.00
-----------------------	-------	----	--	-------

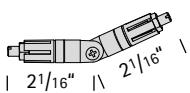

mitre connector for any angle mitre cut \$ 43.00	25653	99		94.50
---	-------	----	--	-------

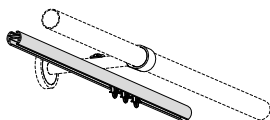

traversing rod and accessories for extra run not for flat brackets			see page 455	
--	--	--	--------------	--

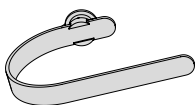

accessories			see page 443	
--------------------	--	--	--------------	--

page 412



page 416

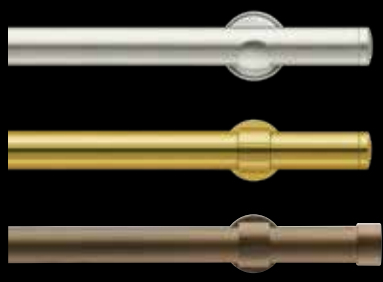

page 420

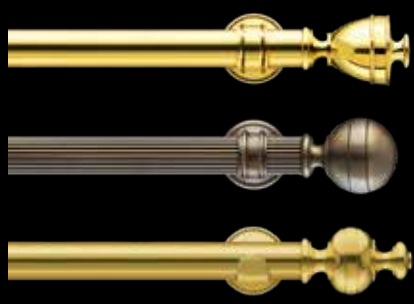

page 426



brass

1 3/16" dia.



regent brushed nickel/crystal glass hand cut



empire brushed brass



palace antique bronzed



tieback antique bronzed p. 448



- 56 black (for tube only)
- 60 polished brass
- 61 antique brass
- 62 brushed brass
- 72 brushed nickel
- 80 antique bronzed

empire 80 antique bronzed



palace 56/60 black/polished brass



regent 60/98 polished brass/crystal glass hand cut

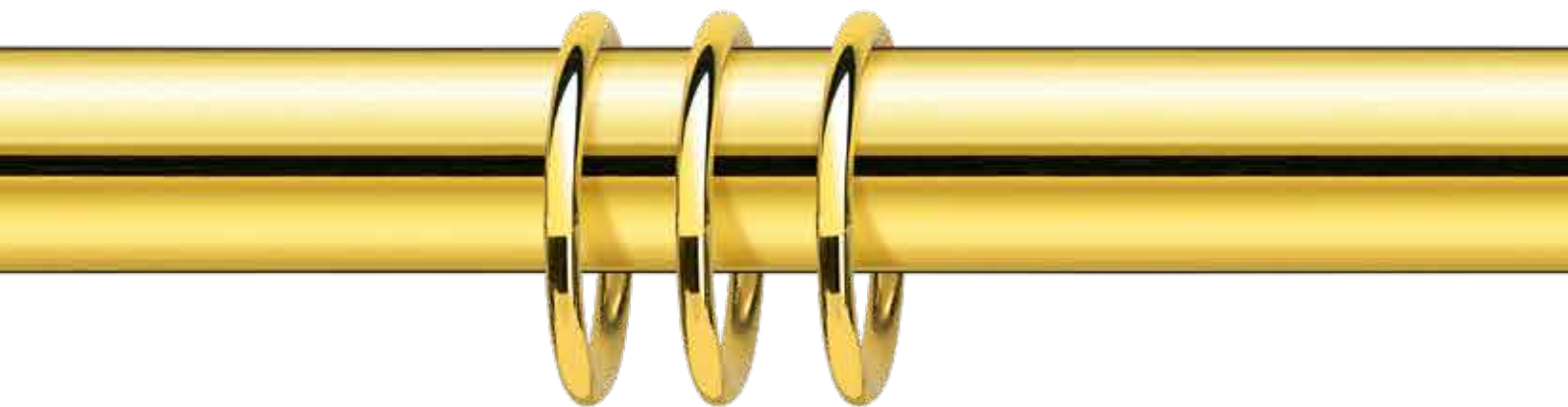

scale 1:1

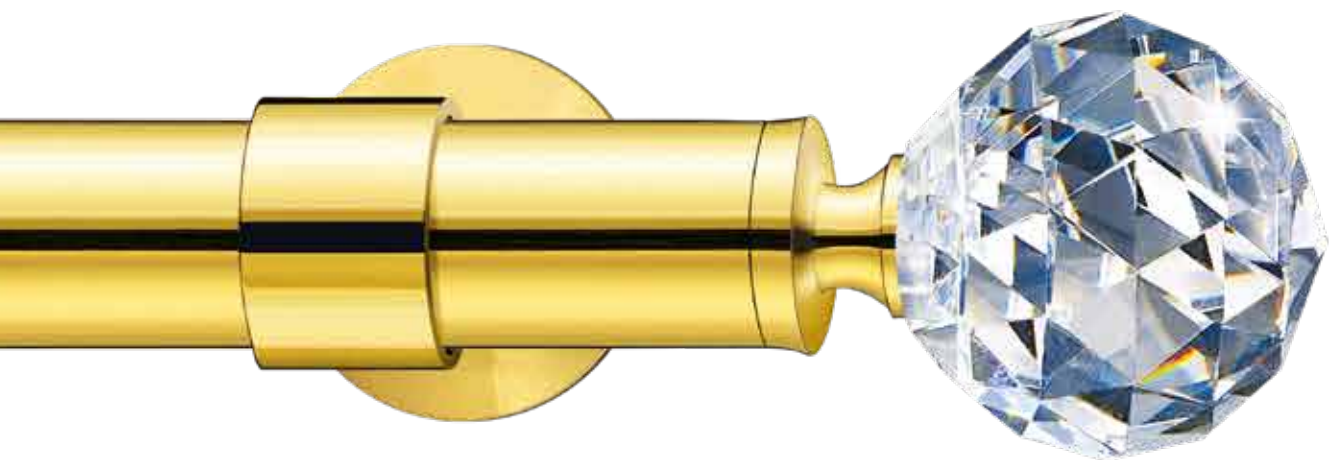
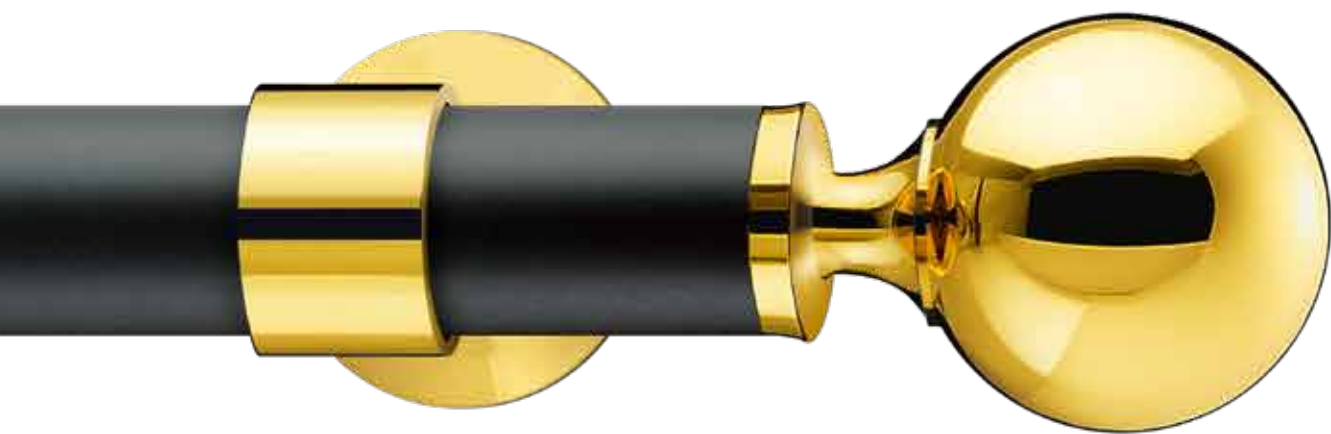

brass 1³/₁₆" dia.

finishes available

- A 60 polished brass
56/60 black/polished brass
- B 61 antique brass
62 brushed brass
- C 72 brushed nickel
80 antique bronzed



single rod

length (ft.)	*rings	brackets		brackets 3" or 5"			brackets 7" or 9"			integral	
				A	B	C	A	B	C	brackets	surcharge
3	14	2	\$	597	713	757	624	744	788	2	363
4	18	2		650	775	823	677	807	855	2	377
5	22	2		702	837	890	729	869	921	2	391
6	26	2		755	900	956	782	931	988	2	405
7	30	3		916	1092	1160	956	1139	1207	2	311
8	34	3		969	1154	1227	1009	1201	1274	2	325
9	38	3		1021	1216	1293	1062	1264	1341	2	339
• 10	42	3		1074	1279	1360	1115	1326	1407	3	621
11	48	3		1140	1357	1443	1181	1404	1490	3	635
12	52	3		1193	1419	1509	1234	1467	1557	3	649
13	56	4		1354	1611	1713	1408	1674	1776	3	555
14	60	4		1407	1673	1780	1461	1736	1843	3	569
15	64	4		1459	1736	1846	1513	1799	1909	3	583
16	68	4		1512	1798	1913	1566	1861	1976	3	597
17	72	4		1565	1860	1980	1619	1924	2042	3	611
18	76	4		1618	1923	2046	1672	1986	2109	3	625
reduction per wall socket				147	177	187	161	192	203		

Empire

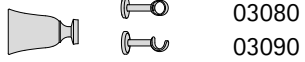

set-no.

03080

03090

Palace

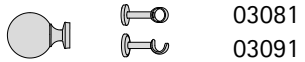

03081

03091

double rod

length (ft.)	*rings	brackets		brackets 3" or 5"			brackets 7" or 9"			integral	
				A	B	C	A	B	C	brackets	surcharge
3	28	2	\$	998	1190	1264	1025	1222	1295	2	698
4	36	2		1103	1315	1397	1130	1346	1428	2	726
5	44	2		1209	1440	1530	1236	1471	1561	2	754
6	52	2		1315	1564	1663	1342	1596	1695	2	782
7	60	3		1598	1903	2023	1639	1950	2070	2	632
8	68	3		1704	2028	2156	1744	2075	2203	2	660
9	76	3		1809	2152	2289	1850	2200	2336	2	688
• 10	84	3		1915	2277	2422	1956	2325	2470	3	1200
11	96	3		2047	2433	2588	2088	2481	2635	3	1228
12	104	3		2153	2558	2721	2194	2605	2768	3	1256
13	112	4		2437	2896	3081	2491	2959	3144	3	1106
14	120	4		2542	3021	3214	2596	3084	3277	3	1134
15	128	4		2648	3146	3347	2702	3209	3410	3	1162
16	136	4		2753	3271	3480	2807	3334	3543	3	1190
17	144	4		2859	3395	3614	2913	3459	3676	3	1218
18	152	4		2965	3520	3747	3019	3583	3810	3	1246
reduction per wall socket				197	236	250	210	251	266		
additional 3/4" between rods				without surcharge							

Empire

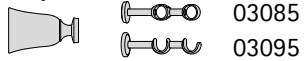

set-no.

03085

03095

Palace

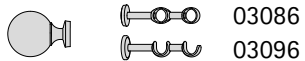

03086

03096

Notes

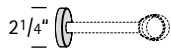

larger base plate
(not for open brackets)

+ \$ 14.00 per bracket

* rings with plastic inserts

• rods in excess of 9ft. will be delivered in two sections
accessories see page 443



brass 1³/₁₆" dia.

finishes available

- A 60/98 polished brass/crystal glass hand cut
- B 72/98 brushed nickel/crystal glass hand cut

single rod

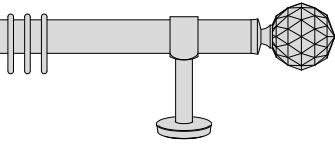

length → 3" |

Regent	set-no.
bracket closed	03082
bracket open	03092

length (ft.)	*rings	brackets	brackets 3" or 5"		brackets 7" or 9"		integral	
			A	B	A	B	brackets surcharge	
3	14	2	\$ 971	1104	998	1136	2	363
4	18	2	1023	1171	1050	1202	2	377
5	22	2	1076	1237	1103	1269	2	391
6	26	2	1129	1304	1156	1335	2	405
7	30	3	1290	1508	1330	1555	2	311
8	34	3	1342	1574	1383	1622	2	325
9	38	3	1395	1641	1436	1688	2	339
• 10	42	3	1448	1708	1489	1755	3	621
11	48	3	1514	1790	1555	1838	3	635
12	52	3	1567	1857	1608	1904	3	649
13	56	4	1728	2061	1782	2124	3	555
14	60	4	1780	2127	1834	2190	3	569
15	64	4	1833	2194	1887	2257	3	583
16	68	4	1886	2261	1940	2323	3	597
17	72	4	1939	2327	1993	2390	3	611
18	76	4	1992	2394	2046	2457	3	625
reduction per wall socket			334	361	348	377		

double rod

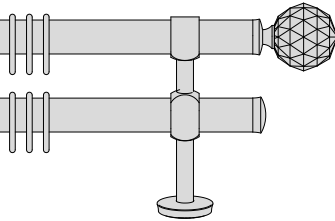

length → 3" |

Regent	set-no.
bracket closed	03087
bracket open	03097

length (ft.)	*rings	brackets	brackets 3" or 5"		brackets 7" or 9"		integral	
			A	B	A	B	brackets surcharge	
3	28	2	\$ 1372	1611	1399	1643	2	698
4	36	2	1477	1744	1504	1776	2	726
5	44	2	1583	1878	1610	1909	2	754
6	52	2	1688	2011	1715	2042	2	782
7	60	3	1972	2370	2013	2418	2	632
8	68	3	2078	2504	2118	2551	2	660
9	76	3	2183	2637	2224	2684	2	688
• 10	84	3	2289	2770	2329	2817	3	1200
11	96	3	2421	2936	2462	2983	3	1228
12	104	3	2527	3069	2567	3116	3	1256
13	112	4	2810	3428	2864	3491	3	1106
14	120	4	2916	3562	2970	3624	3	1134
15	128	4	3022	3695	3076	3758	3	1162
16	136	4	3127	3828	3181	3891	3	1190
17	144	4	3233	3961	3287	4024	3	1218
18	152	4	3338	4094	3392	4157	3	1246
reduction per wall socket			383	424	397	439		
additional 3/4" between rods			without surcharge					
 3/4"								

Notes

- larger base plate + \$ 14.00 per bracket (not for open brackets)
- * rings with plastic inserts
- rods in excess of 9ft. will be delivered in two sections
- accessories see page 443

components see page 429

- 56 black (for tube only)
- 60 polished brass
- 61 antique brass
- 62 brushed brass
- 72 brushed nickel
- 80 antique bronzed

castle 72 brushed nickel



castle 61 antique brass



turnier 80 antique bronzed



scale 1:1

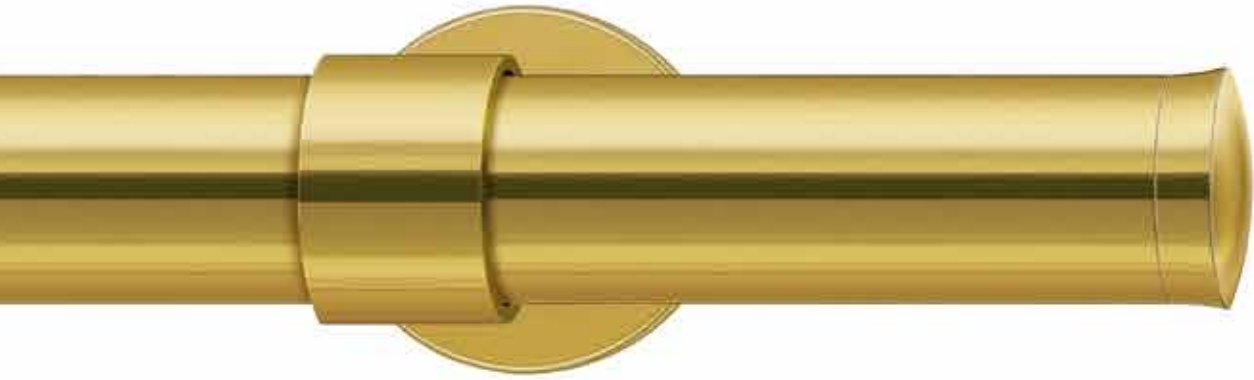

brass 1³/₁₆" dia.

finishes available

- A 60 polished brass
56/60 black/polished brass
- B 61 antique brass
62 brushed brass
- C 72 brushed nickel
80 antique bronzed

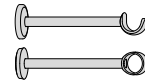

single rod

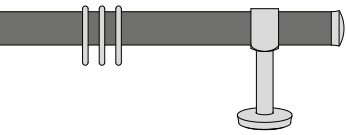

length →

set-no.

Castle



Turnier

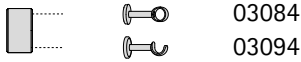

length (ft.)	* rings	brackets		brackets 3" or 5"			brackets 7" or 9"			integral	
				A	B	C	A	B	C	brackets	surcharge
3	14	2	\$	476	568	603	503	599	634	2	363
4	18	2		529	630	670	556	662	701	2	377
5	22	2		582	692	736	609	724	768	2	391
6	26	2		635	755	803	662	786	834	2	405
7	30	3		795	947	1007	836	994	1054	2	311
8	34	3		848	1009	1073	889	1056	1120	2	325
9	38	3		901	1071	1140	941	1119	1187	2	339
• 10	42	3		954	1134	1206	994	1181	1254	3	621
11	48	3		1020	1212	1289	1060	1259	1336	3	635
12	52	3		1073	1274	1356	1113	1322	1403	3	649
13	56	4		1233	1466	1560	1287	1529	1622	3	555
14	60	4		1286	1528	1626	1340	1591	1689	3	569
15	64	4		1339	1591	1693	1393	1654	1756	3	583
16	68	4		1392	1653	1759	1446	1716	1822	3	597
17	72	4		1444	1715	1826	1498	1779	1889	3	611
18	76	4		1497	1778	1893	1551	1841	1955	3	625
reduction per wall socket				87	104	111	100	120	126		

| 3³/₅" | 3" |

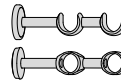

| 7⁷/₉" | 3" |

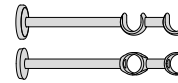

double rod

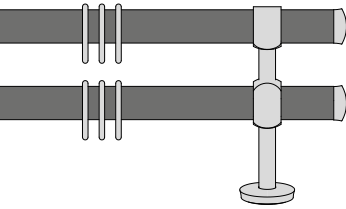

length →

set-no.

Castle

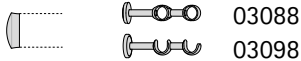

Turnier

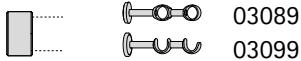

length (ft.)	* rings	brackets		brackets 3" or 5"			brackets 7" or 9"			integral	
				A	B	C	A	B	C	brackets	surcharge
3	28	2	\$	877	1045	1110	904	1077	1141	2	698
4	36	2		983	1170	1243	1010	1201	1275	2	726
5	44	2		1088	1295	1376	1115	1326	1408	2	754
6	52	2		1194	1419	1510	1221	1451	1541	2	782
7	60	3		1478	1758	1869	1518	1805	1916	2	632
8	68	3		1583	1883	2002	1624	1930	2050	2	660
9	76	3		1689	2007	2136	1729	2055	2183	2	688
• 10	84	3		1794	2132	2269	1835	2180	2316	3	1200
11	96	3		1927	2288	2434	1967	2336	2482	3	1228
12	104	3		2032	2413	2568	2073	2460	2615	3	1256
13	112	4		2316	2751	2927	2370	2814	2990	3	1106
14	120	4		2422	2876	3060	2476	2939	3123	3	1134
15	128	4		2527	3001	3194	2581	3064	3256	3	1162
16	136	4		2633	3126	3327	2687	3189	3390	3	1190
17	144	4		2738	3250	3460	2792	3314	3523	3	1218
18	152	4		2844	3375	3593	2898	3438	3656	3	1246
reduction per wall socket				136	163	173	150	179	189		
additional 3/4" between rods				without surcharge							

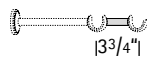

Notes

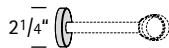

larger base plate
(not for open brackets)

+ \$ 14.00 per bracket

* rings with plastic inserts

• rods in excess of 9ft. will be delivered in two sections
accessories see page 443





juventus antique brass



jewel antique bronzed



jamaica polished brass



holdback polished brass p. 446



finishes available

- 60 polished brass
- 61 antique brass
- 62 brushed brass
- 80 antique bronzed

jewel 60 polished brass



juventus 80 antique bronzed



jamaica 61 antique brass



scale 1:1

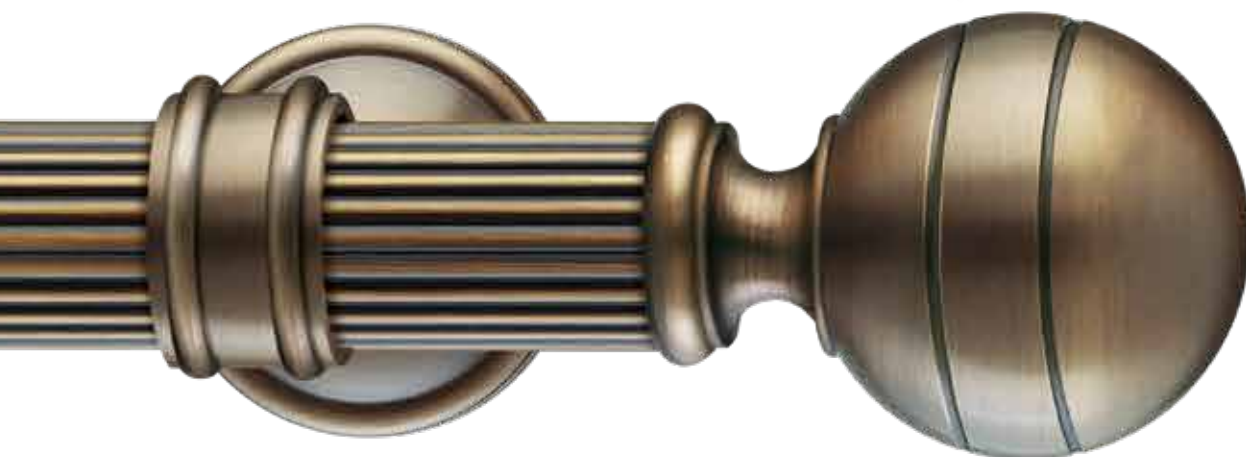

brass 1³/₁₆" dia.

finishes available

- A 60 polished brass
- B 61 antique brass (for smooth tube only)
- 62 brushed brass (for smooth tube only)
- C 80 antique bronzed

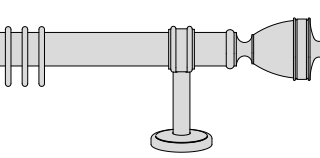
single rod (closed bracket)	length (ft.)	* rings	brackets	brackets 3" or 5"			brackets 7" or 9"			integral		
				A	B	C	A	B	C	brackets	surcharge	
 length → set-no. Jewel 03028 ○ smooth ■ 03029 ○ fluted Juventus 03026 ○ smooth ■ 03027 ○ fluted Jamaica 03024 ○ smooth ■ 03025 ○ fluted	3	14	2	\$ 608	726	771	635	758	802	2	335	
	4	18	2	660	788	837	687	820	869	2	349	
	5	22	2	713	851	904	740	882	935	2	363	
	6	26	2	766	913	971	793	945	1002	2	377	
	7	30	3	941	1122	1193	982	1170	1240	2	269	
	8	34	3	994	1185	1259	1034	1232	1307	2	283	
	9	38	3	1047	1247	1326	1087	1295	1373	2	297	
	• 10	42	3	1099	1310	1393	1140	1357	1440	3	579	
	11	48	3	1166	1388	1475	1206	1435	1523	3	593	
	12	52	3	1218	1450	1542	1259	1497	1589	3	607	
	13	56	4	1393	1659	1764	1447	1722	1827	3	499	
	14	60	4	1446	1721	1831	1500	1785	1894	3	513	
	15	64	4	1499	1784	1897	1553	1847	1960	3	527	
	16	68	4	1552	1846	1964	1606	1909	2027	3	541	
	17	72	4	1605	1909	2031	1659	1972	2093	3	555	
	18	76	4	1657	1971	2097	1711	2034	2160	3	569	
	reduction per wall socket				153	183	194	166	199	210		

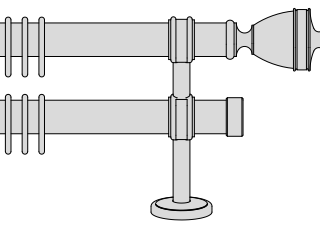
double rod (closed bracket)	length (ft.)	* rings	brackets	brackets 3" or 5"			brackets 7" or 9"			integral		
				A	B	C	A	B	C	brackets	surcharge	
 length → set-no. Jewel 03060 ○ smooth ■ 03069 ○ fluted Juventus 03076 ○ smooth ■ 03077 ○ fluted Jamaica 03072 ○ smooth ■ 03073 ○ fluted	3	28	2	\$ 1027	1225	1301	1054	1257	1332	2	670	
	4	36	2	1132	1350	1434	1159	1381	1465	2	698	
	5	44	2	1238	1475	1567	1265	1506	1598	2	726	
	6	52	2	1343	1599	1700	1370	1631	1732	2	754	
	7	60	3	1650	1966	2090	1691	2013	2137	2	581	
	8	68	3	1756	2091	2223	1797	2138	2270	2	609	
	9	76	3	1862	2216	2356	1902	2263	2403	2	637	
	• 10	84	3	1967	2340	2489	2008	2388	2536	3	1158	
	11	96	3	2100	2496	2655	2140	2544	2702	3	1186	
	12	104	3	2205	2621	2788	2246	2669	2835	3	1214	
	13	112	4	2512	2988	3177	2566	3051	3240	3	1041	
	14	120	4	2618	3112	3311	2672	3176	3373	3	1069	
	15	128	4	2723	3237	3444	2777	3300	3507	3	1097	
	16	136	4	2829	3362	3577	2883	3425	3640	3	1125	
	17	144	4	2935	3487	3710	2989	3550	3773	3	1153	
	18	152	4	3040	3612	3843	3094	3675	3906	3	1181	
	reduction per wall socket				211	253	268	224	269	284		
	additional 3/4" between rods				without surcharge							

Notes

- integral not available for fluted tubes
 - * rings with plastic insert
 - rods in excess of 9ft. will be delivered in two sections
- accessories see page 443



brass 1 3/16" dia.

finishes available

- A 60 polished brass
- B 61 antique brass (for smooth tube only)
- 62 brushed brass (for smooth tube only)
- C 80 antique bronzed

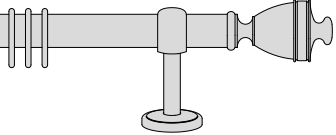
single rod (open bracket)	length (ft.)	*rings	brackets	brackets 3" or 5"			brackets 7" or 9"			integral		
				A	B	C	A	B	C	brackets surcharge		
 <p>Länge →</p> <p>set-no.</p> <p>Jewel 03030 ○ smooth ■ 03039 ⊗ fluted</p> <p>Juventus 03043 ○ smooth ■ 03044 ⊗ fluted</p> <p>Jamaica 03041 ○ smooth ■ 03042 ⊗ fluted</p>	3	14	2	\$ 579	691	734	606	723	765	2	335	
	4	18	2	632	754	801	659	785	832	2	349	
	5	22	2	684	816	867	711	848	899	2	363	
	6	26	2	737	878	934	764	910	965	2	377	
	7	30	3	898	1070	1138	938	1118	1185	2	283	
	8	34	3	951	1133	1204	991	1180	1251	2	297	
	9	38	3	1003	1195	1271	1044	1242	1318	2	311	
	• 10	42	3	1056	1257	1337	1097	1305	1385	3	579	
	11	48	3	1122	1335	1420	1163	1383	1467	3	593	
	12	52	3	1175	1398	1487	1216	1445	1534	3	607	
	13	56	4	1336	1589	1691	1390	1653	1753	3	513	
	14	60	4	1389	1652	1757	1443	1715	1820	3	527	
	15	64	4	1441	1714	1824	1495	1777	1887	3	541	
	16	68	4	1494	1777	1890	1548	1840	1953	3	555	
	17	72	4	1547	1839	1957	1601	1902	2020	3	569	
	18	76	4	1600	1901	2024	1654	1965	2086	3	583	
				reduction per wall socket	138	166	176	152	182	192		

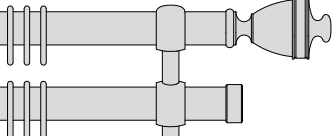
double rod (open bracket)	length (ft.)	*rings	brackets	brackets 3" or 5"			brackets 7" or 9"			integral		
				A	B	C	A	B	C	brackets surcharge		
 <p>Länge →</p> <p>set-no.</p> <p>Jewel 03040 ○ smooth ■ 03049 ⊗ fluted</p> <p>Juventus 03047 ○ smooth ■ 03048 ⊗ fluted</p> <p>Jamaica 03045 ○ smooth ■ 03046 ⊗ fluted</p>	3	28	2	\$ 980	1169	1241	1007	1200	1272	2	670	
	4	36	2	1085	1293	1374	1112	1325	1406	2	698	
	5	44	2	1191	1418	1507	1218	1450	1539	2	726	
	6	52	2	1297	1543	1641	1324	1575	1672	2	754	
	7	60	3	1580	1881	2000	1621	1929	2047	2	604	
	8	68	3	1686	2006	2133	1726	2054	2181	2	632	
	9	76	3	1791	2131	2267	1832	2178	2314	2	660	
	• 10	84	3	1897	2256	2400	1938	2303	2447	3	1158	
	11	96	3	2029	2412	2565	2070	2459	2613	3	1186	
	12	104	3	2135	2537	2699	2176	2584	2746	3	1214	
	13	112	4	2419	2875	3058	2473	2938	3121	3	1064	
	14	120	4	2524	3000	3191	2578	3063	3254	3	1092	
	15	128	4	2630	3124	3325	2684	3188	3387	3	1120	
	16	136	4	2735	3249	3458	2789	3312	3521	3	1148	
	17	144	4	2841	3374	3591	2895	3437	3654	3	1176	
	18	152	4	2947	3499	3724	3001	3562	3787	3	1204	
				reduction per wall socket	188	225	239	201	241	254		
				additional 3/4" between rods	without surcharge							

Notes

- integral not available for fluted tubes
 - * rings with plastic insert
 - rods in excess of 9ft. will be delivered in two sections
- accessories see page 443





saba antique bronzed



salomo brushed nickel

finishes available

60 polished brass

72 brushed nickel

80 antique bronzed

salomo 80 antique bronzed



saba 60 polished brass



scale 1:1



brass 1³/₁₆" dia.

finishes available

- A 60 polished brass
- B 72 brushed nickel
- 80 antique bronzed

single rod

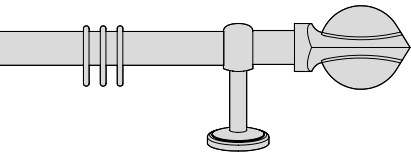

length →



-  **Saba** 03056
-  **Salomo** 03057

length (ft.)	* rings	brackets		brackets 3" or 5"		brackets 7" or 9"		integral	
				A	B	A	B	brackets	surcharge
3	14	2	\$	628	795	655	826	2	335
4	18	2		681	861	708	893	2	349
5	22	2		734	928	761	959	2	363
6	26	2		787	994	814	1026	2	377
7	30	3		947	1198	988	1245	2	283
8	34	3		1000	1265	1041	1312	2	297
9	38	3		1053	1331	1093	1379	2	311
• 10	42	3		1106	1398	1146	1445	3	579
11	48	3		1172	1481	1212	1528	3	593
12	52	3		1225	1547	1265	1595	3	607
13	56	4		1385	1751	1439	1814	3	513
14	60	4		1438	1818	1492	1881	3	527
15	64	4		1491	1884	1545	1947	3	541
16	68	4		1544	1951	1598	2014	3	555
17	72	4		1596	2018	1650	2080	3	569
18	76	4		1649	2084	1703	2147	3	583
reduction per wall socket				163	206	176	222		

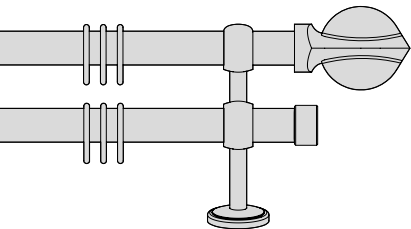
double rod



length →

-  **Saba** 03058
-  **Salomo** 03059

length (ft.)	* rings	brackets		brackets 3" or 5"		brackets 7" or 9"		integral	
				A	B	A	B	brackets	surcharge
3	28	2	\$	1029	1302	1056	1333	2	670
4	36	2		1135	1435	1162	1466	2	698
5	44	2		1240	1568	1267	1599	2	726
6	52	2		1346	1701	1373	1733	2	754
7	60	3		1630	2061	1670	2108	2	604
8	68	3		1735	2194	1776	2241	2	632
9	76	3		1841	2327	1881	2374	2	660
• 10	84	3		1946	2460	1987	2508	3	1158
11	96	3		2079	2626	2119	2673	3	1186
12	104	3		2184	2759	2225	2806	3	1214
13	112	4		2468	3119	2522	3182	3	1064
14	120	4		2574	3252	2628	3315	3	1092
15	128	4		2679	3385	2733	3448	3	1120
16	136	4		2785	3518	2839	3581	3	1148
17	144	4		2890	3652	2944	3714	3	1176
18	152	4		2996	3785	3050	3848	3	1204
reduction per wall socket				212	269	226	285		
additional 3/4" between rods				without surcharge					

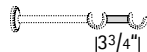

Notes



- * rings with plastic inserts
- rods in excess of 9ft. will be delivered in two sections

accessories







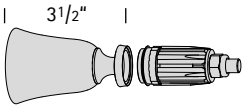
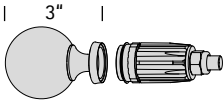
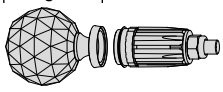
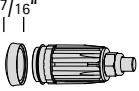
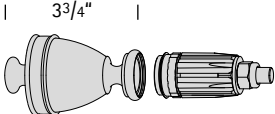
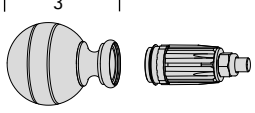
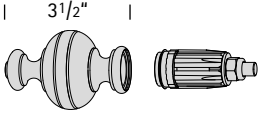
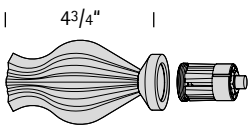
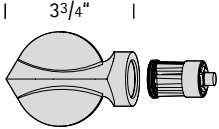

see page 443

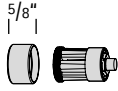
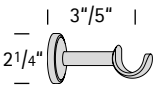
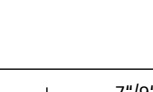
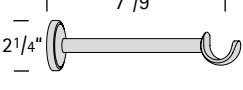
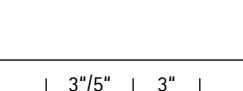
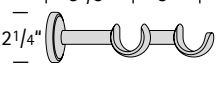
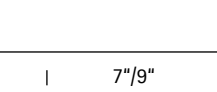
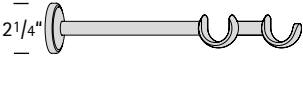
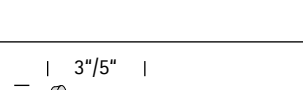
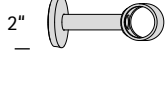

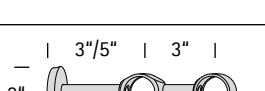

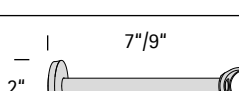
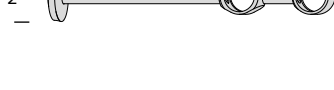
brass 1³/₁₆" dia.

components	part	part-no.	color-no.	price	
	brass tube 1³/₁₆" dia. smooth	30610	56 black	Cut to measure \$/ lin. ft. 26.00	
			60 polished brass		26.00
			61 antique brass		31.20
			62 brushed brass		31.20
			72 brushed nickel		34.20
			80 antique bronzed		34.20
	brass tube 1³/₁₆" dia. fluted	30630	60 polished brass	Cut to measure \$/ lin. ft. 26.00	
			80 antique bronzed		34.20
 3 ¹ / ₂ "  3"	finial Empire Palace	30801 30802	60 polished brass	104.70	
			61 antique brass		125.60
			62 brushed brass	125.60	
			72 brushed nickel	133.10	
			80 antique bronzed	133.10	
 3"	finial Regent	30803	60/98 polished brass/crys. glass hand cut	291.60	
			72/98 brushed nickel/crys. glass hand cut	306.90	
 7/16"	end cap Castle	30829	60 polished brass	44.40	
			61 antique brass	53.10	
			62 brushed brass	53.10	
			72 brushed nickel	56.30	
			80 antique bronzed	56.30	
 3 ³ / ₄ "  3"	finial Jewel Juventus	30701 30602	60 polished brass	95.70	
			61 antique brass		114.90
			62 brushed brass	114.90	
			80 antique bronzed	121.80	
 3 ¹ / ₂ "	finial Jamaica	30601			
 4 ³ / ₄ "  3 ³ / ₄ "	finial Salomo Saba	30901 30903	60 polished brass	120.40	
			72 brushed nickel		152.10
			80 antique bronzed		152.10

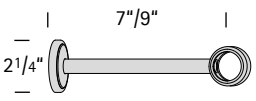
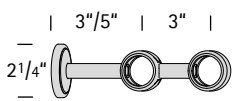
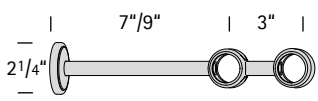
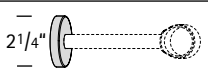
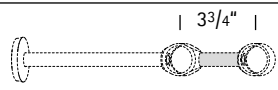
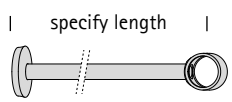
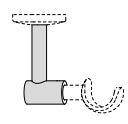

brass 1³/₁₆" dia.

components	part		part-no.	color-no.	price	
	end cap Turnier		30729	60	polished brass	44.40
				61	antique brass	53.10
				62	brushed brass	53.10
				72	brushed nickel	56.30
				80	antique bronzed	56.30
	bracket open	3"	30631	60	polished brass	107.80
				61	antique brass	129.30
				62	brushed brass	129.30
				72	brushed nickel	137.20
		5"	30632	80	antique bronzed	137.20
	bracket open	7"	30633	60	polished brass	121.30
				61	antique brass	145.10
				62	brushed brass	145.10
				72	brushed nickel	152.90
		9"	30634	80	antique bronzed	152.90
	double bracket open	3"	30641	60	polished brass	178.00
				61	antique brass	213.50
				62	brushed brass	213.50
				72	brushed nickel	226.40
		5"	30642	80	antique bronzed	226.40
	double bracket open	7"	30643	60	polished brass	191.50
				61	antique brass	229.30
				62	brushed brass	229.30
				72	brushed nickel	242.10
		9"	30644	80	antique bronzed	242.10
	bracket	3"	30831	60	polished brass	107.80
				61	antique brass	129.30
				62	brushed brass	129.30
				72	brushed nickel	137.20
		5"	30832	80	antique bronzed	137.20
	bracket	7"	30833	60	polished brass	121.30
				61	antique brass	145.10
				62	brushed brass	145.10
				72	brushed nickel	152.90
		9"	30834	80	antique bronzed	152.90
	double bracket	3"	30841	60	polished brass	178.00
				61	antique brass	213.50
				62	brushed brass	213.50
				72	brushed nickel	226.40
		5"	30842	80	antique bronzed	226.40
	double bracket	7"	30843	60	polished brass	191.50
				61	antique brass	229.30
				62	brushed brass	229.30
				72	brushed nickel	242.10
		9"	30844	80	antique bronzed	242.10
	bracket closed for Jewel, Juventus, Jamaica	3"	30731	60	polished brass	122.20
				61	antique brass	146.70
				62	brushed brass	146.70
				80	antique bronzed	155.60
		5"	30732	80	antique bronzed	155.60

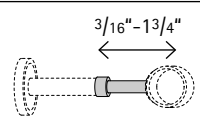
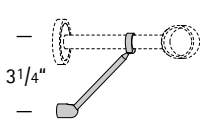
brass 1³/₁₆" dia.

components	part	part-no.	color-no.	price
	bracket closed for Jewel, Juventus, Jamaica	7"	30733	60 polished brass 135.70 61 antique brass 162.50
		9"	30734	62 brushed brass 162.50 80 antique bronzed 171.30
	double bracket closed for Jewel, Juventus, Jamaica	3"	30741	60 polished brass 201.40 61 antique brass 241.70
		5"	30742	62 brushed brass 241.70 80 antique bronzed 256.20
	double bracket closed for Jewel, Juventus, Jamaica	7"	30743	60 polished brass 214.90 61 antique brass 257.50
		9"	30744	62 brushed brass 257.50 80 antique bronzed 271.90
	larger base plate for brackets 30831 -30844 e.g. 30832X	X		surcharge 14.00
	additional distance between rods with double rod e.g. 30741L	L		without surcharge
	shorten bracket e.g. 30832-60-S-4"	S		surcharge 43.00
	ceiling converter for ceiling mounts			see page 454
	extension piece 1"	30719	60 polished brass 19.00 61 antique brass 22.70 62 brushed brass 22.70 72 brushed nickel 24.10 80 antique bronzed 24.10	
	extension piece extendable	30619	60 polished brass 35.60 62 brushed brass 42.80 72 brushed nickel 45.20 80 antique bronzed 45.20	
	bracket support light duty can be retrofitted	20617	60 polished brass 82.20 61 antique brass 100.20 62 brushed brass 100.20 72 brushed nickel 100.20 80 antique bronzed 100.20	

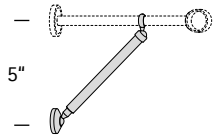
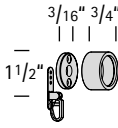
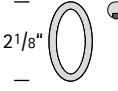
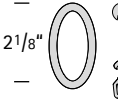
brass 1³/₁₆" dia.

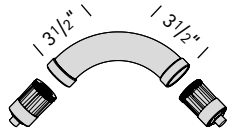
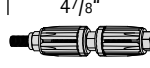
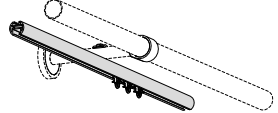
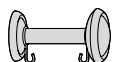
components	part	part-no.	color-no.	price
	bracket support can be retrofitted	30617	60 polished brass 61 antique brass 62 brushed brass 72 brushed nickel 80 antique bronzed	180.70 216.60 216.60 228.70 228.70
	wall socket with anchor clip can be used at both ends	30705	56 black 60 polished brass 61 antique brass 62 brushed brass 72 brushed nickel 80 antique bronzed	65.30 65.30 78.30 78.30 83.00 83.00
	ring wide 2¹/₈" x 3³/₁₆" with plastic insert	30709	60 polished brass 61 antique brass 62 brushed brass 72 brushed nickel 80 antique bronzed	6.50 7.60 7.60 7.90 7.90
	ring wide 2¹/₈" x 3³/₁₆" with eyelet clip with plastic insert	30708	60 polished brass 61 antique brass 62 brushed brass 72 brushed nickel 80 antique bronzed	6.70 7.80 7.80 8.10 8.10
	eyelet clip	10925	50 white	0.20
	elbow 90° any angle cut to measure from 90° to 160° surcharge \$ 56.00 not for fluted tube	30650	60 polished brass 62 brushed brass 72 brushed nickel 80 antique bronzed	153.10 183.60 194.70 194.70
	tube connector	30659	99	24.80
	traversing rod and accessories for extra run		see page 455	
	accessories		see page 443	

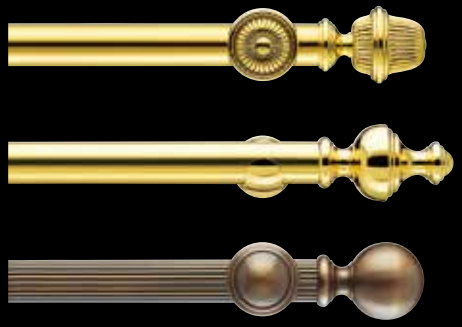

brass

1 3/8"
dia.



odeon antique bronzed



ora polished brass



prestige polished brass

tieback polished brass p. 450



finishes available

60 polished brass

80 antique bronzed

prestige 60 polished brass

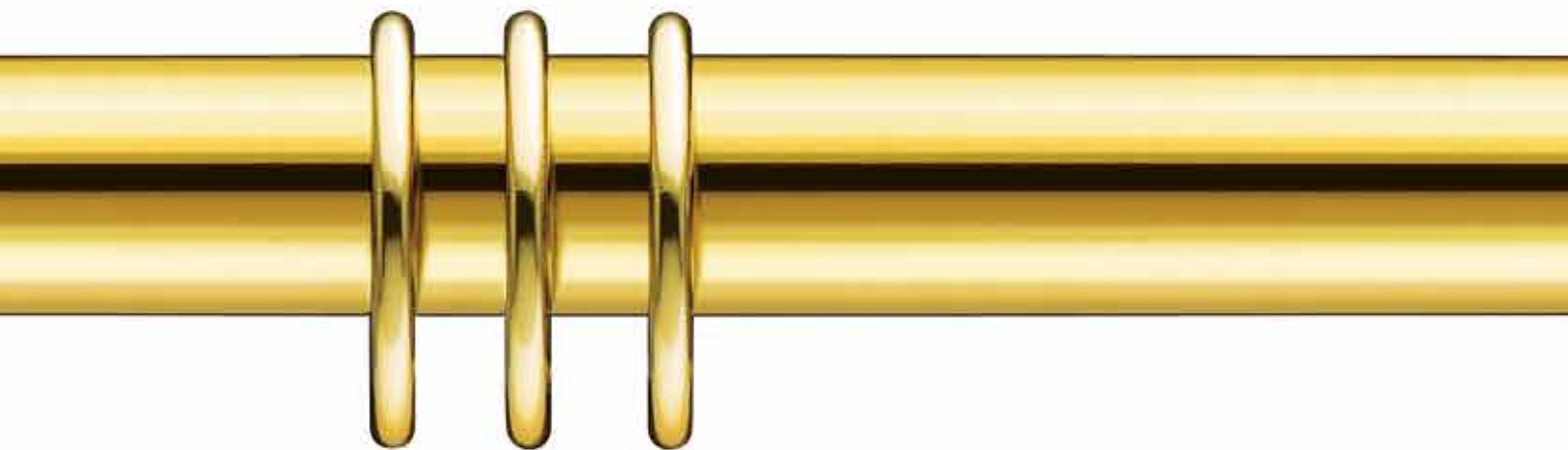

odeon 60 polished brass



ora 80 antique bronzed



scale 1:1

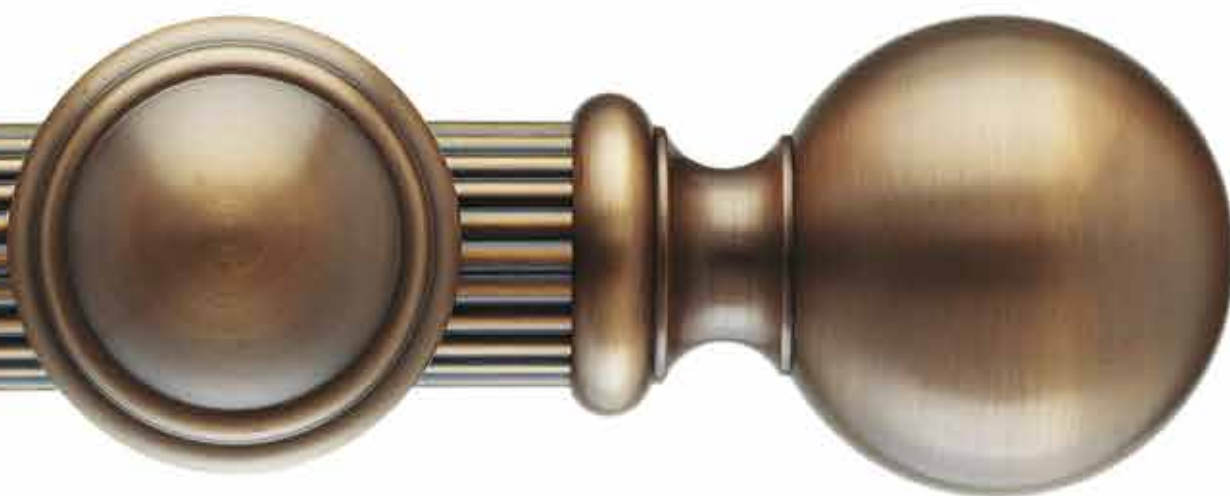
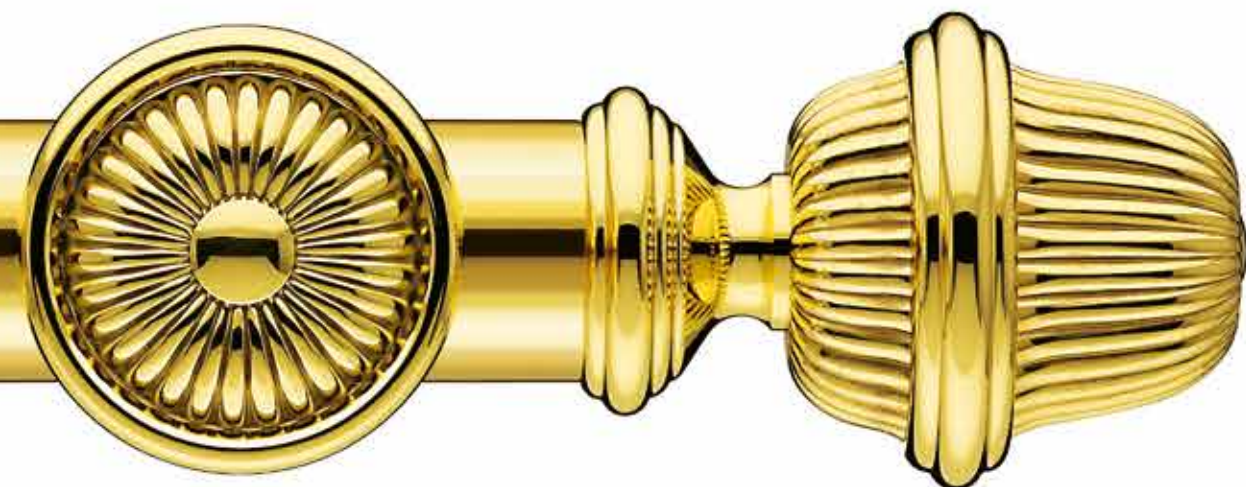

brass 1 3/8" dia.

finishes available

- A 60 polished brass
- B 80 antique bronzed

single rod (open bracket)

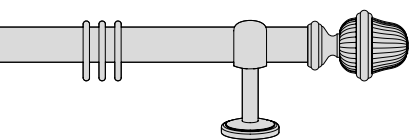

length → 3 1/2" |

set-no.

- Prestige** 03561 ○ smooth
- 03562 ○ fluted

length *rings brackets



brackets 3" or 5"



brackets 7" or 9"

(ft.)

				A	B	A	B
	3	14	2	\$ 746	945	773	977
	4	18	2	806	1025	833	1057
	5	22	2	866	1106	893	1137
	6	26	2	926	1186	953	1217
	7	30	3	1099	1410	1140	1457
	8	34	3	1159	1490	1200	1537
	9	38	3	1219	1570	1260	1617
•	10	42	3	1279	1650	1320	1697
	11	48	3	1355	1749	1396	1796
	12	52	3	1415	1829	1456	1876
	13	56	4	1588	2053	1642	2116
	14	60	4	1648	2133	1702	2196
	15	64	4	1708	2214	1762	2276
	16	68	4	1768	2294	1822	2356
	17	72	4	1828	2374	1882	2437
	18	76	4	1888	2454	1942	2517
	reduction per wall socket			197	243	210	259

double rod (open bracket)

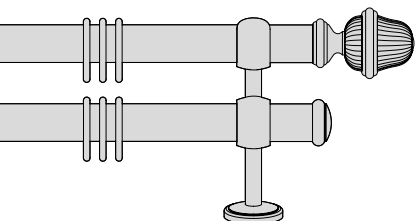

length → 3 1/2" |

set-no.

- Prestige** 03563 ○ smooth
- 03564 ○ fluted

length *rings brackets

| 3 5/8" | 3" |



brackets 3" or 5"

| 7 9/16" | 3" |

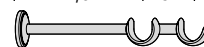

brackets 7" or 9"

(ft.)

				A	B	A	B
	3	28	2	\$ 1184	1512	1211	1543
	4	36	2	1304	1672	1331	1703
	5	44	2	1424	1832	1451	1863
	6	52	2	1544	1992	1571	2024
	7	60	3	1847	2386	1888	2433
	8	68	3	1967	2546	2008	2593
	9	76	3	2087	2706	2128	2753
•	10	84	3	2207	2866	2248	2913
	11	96	3	2358	3064	2399	3111
	12	104	3	2478	3224	2519	3271
	13	112	4	2782	3618	2836	3681
	14	120	4	2902	3778	2956	3841
	15	128	4	3022	3938	3076	4001
	16	136	4	3142	4098	3196	4161
	17	144	4	3262	4259	3316	4321
	18	152	4	3382	4419	3436	4482
	reduction per wall socket			239	296	252	312

additional 3/4" between rods

without surcharge

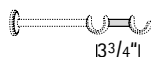

Notes

* rings with plastic inserts

• rods in excess of 9ft. will be delivered in two sections

accessories





see page 443





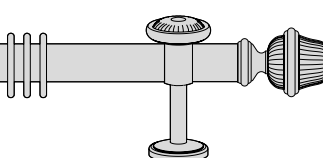

brass 1 3/8" dia.

finishes available

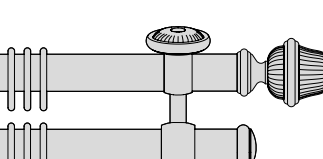
- A 60 polished brass
- B 80 antique bronzed

single rod (bracket with rosette)	length (ft.)	*rings	brackets	brackets 3" or 5"		brackets 7" or 9"		
				A	B	A	B	
 <p>length \rightarrow 3 1/2" </p> <p>set-no.</p> <p> Prestige 03569  smooth 03570  fluted</p>	3	14	2	\$ 958	1211	985	1243	
	4	18	2	1018	1291	1045	1323	
	5	22	2	1078	1371	1105	1403	
	6	26	2	1138	1451	1165	1483	
	7	30	3	1417	1809	1457	1856	
	8	34	3	1477	1889	1517	1936	
	9	38	3	1537	1969	1577	2016	
	• 10	42	3	1597	2049	1637	2096	
	11	48	3	1672	2148	1713	2195	
	12	52	3	1732	2228	1773	2275	
	13	56	4	2011	2585	2065	2648	
	14	60	4	2071	2665	2125	2728	
	15	64	4	2131	2745	2185	2808	
	16	68	4	2191	2825	2245	2888	
	17	72	4	2251	2905	2305	2968	
	18	76	4	2311	2985	2365	3048	
	reduction per wall socket				302	376	316	392

double rod (bracket with rosette)	length (ft.)	*rings	brackets	brackets 3" or 5"		brackets 7" or 9"		
				A	B	A	B	
 <p>length \rightarrow 3 1/2" </p> <p>set-no.</p> <p> Prestige 03571  smooth 03572  fluted</p>	3	28	2	\$ 1395	1777	1422	1809	
	4	36	2	1515	1938	1542	1969	
	5	44	2	1635	2098	1662	2129	
	6	52	2	1755	2258	1782	2289	
	7	60	3	2164	2784	2205	2832	
	8	68	3	2284	2945	2325	2992	
	9	76	3	2404	3105	2445	3152	
	• 10	84	3	2524	3265	2565	3312	
	11	96	3	2676	3463	2716	3510	
	12	104	3	2796	3623	2836	3670	
	13	112	4	3205	4149	3259	4212	
	14	120	4	3325	4310	3379	4372	
	15	128	4	3445	4470	3499	4533	
	16	136	4	3565	4630	3619	4693	
	17	144	4	3685	4790	3739	4853	
	18	152	4	3805	4950	3859	5013	
	reduction per wall socket				344	429	358	445
	additional 3/4" between rods				without surcharge			

Notes

* rings with plastic inserts

• rods in excess of 9ft. will be delivered in two sections



accessories

see page 443

components see page 440

brass 1 3/8" dia.

finishes available

- A 60 polished brass
- B 80 antique bronzed

single rod (open bracket)

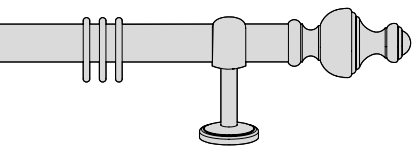

length →

 **Odeon** 03531 ○ smooth
03532 ⊗ fluted

 **Ora** 03533 ○ smooth
03534 ⊗ fluted

set-no.

length *rings brackets

(ft.)

3	14	2
4	18	2
5	22	2
6	26	2
7	30	3
8	34	3
9	38	3
• 10	42	3
11	48	3
12	52	3
13	56	4
14	60	4
15	64	4
16	68	4
17	72	4
18	76	4

reduction per wall socket



brackets 3" or 5"



brackets 7" or 9"

	A	B	A	B
\$	708	907	735	939
	768	987	795	1019
	828	1067	855	1099
	888	1147	915	1179
	1061	1372	1102	1419
	1121	1452	1162	1499
	1181	1532	1222	1579
	1241	1612	1282	1659
	1317	1711	1357	1758
	1377	1791	1417	1838
	1550	2015	1604	2078
	1610	2095	1664	2158
	1670	2175	1724	2238
	1730	2255	1784	2318
	1790	2336	1844	2398
	1850	2416	1904	2478
	177	224	191	240

double rod (open bracket)

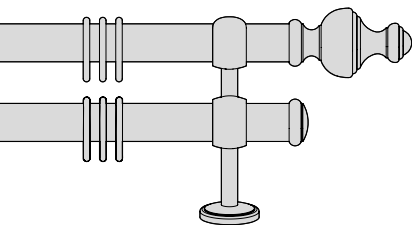

length →

 **Odeon** 03535 ○ smooth
03536 ⊗ fluted

 **Ora** 03537 ○ smooth
03538 ⊗ fluted

set-no.

length *rings brackets

(ft.)

3	28	2
4	36	2
5	44	2
6	52	2
7	60	3
8	68	3
9	76	3
• 10	84	3
11	96	3
12	104	3
13	112	4
14	120	4
15	128	4
16	136	4
17	144	4
18	152	4

reduction per wall socket

additional 3/4" between rods

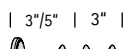

brackets 3" or 5"

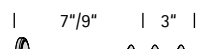

brackets 7" or 9"

	A	B	A	B
\$	1145	1473	1172	1505
	1265	1634	1292	1665
	1385	1794	1412	1825
	1505	1954	1532	1985
	1809	2348	1849	2395
	1929	2508	1969	2555
	2049	2668	2089	2715
	2169	2828	2209	2875
	2320	3026	2360	3073
	2440	3186	2480	3233
	2743	3580	2797	3642
	2863	3740	2917	3803
	2983	3900	3037	3963
	3103	4060	3157	4123
	3223	4220	3277	4283
	3343	4381	3397	4443
	219	277	233	293

without surcharge

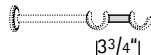

Notes

* rings with plastic inserts

• rods in excess of 9ft. will be delivered in two sections

accessories

see page 443



brass 1 3/8" dia.

finishes available

- A 60 polished brass
- B 80 antique bronzed

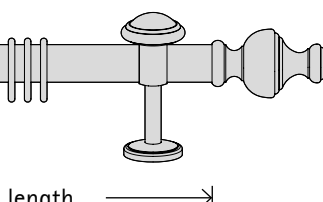
single rod (bracket with rosette)	length	*rings	brackets	brackets 3" or 5"		brackets 7" or 9"	
				A	B	A	B
	(ft.)						
	3	14	2	\$ 897	1144	924	1176
	4	18	2	957	1224	984	1256
	5	22	2	1017	1304	1044	1336
	6	26	2	1077	1384	1104	1416
	7	30	3	1345	1727	1385	1774
	8	34	3	1405	1807	1445	1854
	9	38	3	1465	1887	1505	1934
	• 10	42	3	1525	1967	1565	2015
	11	48	3	1600	2066	1641	2113
	12	52	3	1660	2146	1701	2194
	13	56	4	1928	2489	1982	2552
	14	60	4	1988	2569	2042	2632
	15	64	4	2048	2649	2102	2712
	16	68	4	2108	2729	2162	2792
	17	72	4	2168	2810	2222	2872
	18	76	4	2228	2890	2282	2952
	reduction per wall socket			272	342	285	358

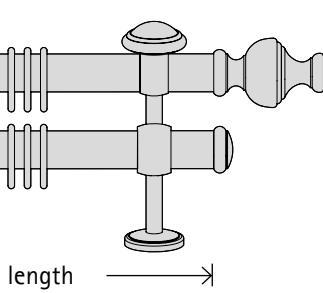
double rod (bracket with rosette)	length	*rings	brackets	brackets 3" or 5"		brackets 7" or 9"	
				A	B	A	B
	(ft.)						
	3	28	2	\$ 1334	1710	1361	1742
	4	36	2	1454	1871	1481	1902
	5	44	2	1574	2031	1601	2062
	6	52	2	1694	2191	1721	2222
	7	60	3	2092	2703	2133	2750
	8	68	3	2212	2863	2253	2910
	9	76	3	2332	3023	2373	3071
	• 10	84	3	2452	3184	2493	3231
	11	96	3	2603	3381	2644	3429
	12	104	3	2723	3542	2764	3589
	13	112	4	3121	4054	3175	4116
	14	120	4	3241	4214	3295	4277
	15	128	4	3361	4374	3415	4437
	16	136	4	3481	4534	3535	4597
	17	144	4	3601	4694	3655	4757
	18	152	4	3721	4855	3775	4917
	reduction per wall socket			314	396	327	411
additional 3/4" between rods			without surcharge				

Notes

* rings with plastic inserts

• rods in excess of 9ft. will be delivered in two sections









accessories

see page 443

components see page 440

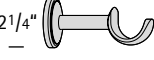
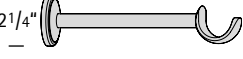
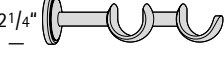
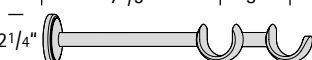
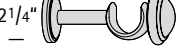

brass 1³/₈" dia.

components	part	part-no.	color-no.	price		
	brass tube 1 ³ / ₈ " dia. smooth	35610	60	polished brass	Cut to measure \$ / lin. ft. 28.80	
			80	antique bronzed	42.50	
	brass tube 1 ³ / ₈ " dia. fluted	35630	60	polished brass	Cut to measure \$ / lin. ft. 28.80	
			80	antique bronzed	42.50	
3 ¹ / ₂ " 	finial Prestige	35701	60	polished brass	162.10	
			80	antique bronzed	199.00	
4 ¹ / ₄ " 	finial Odeon	35601	60	polished brass	142.90	
			80	antique bronzed	179.90	
3 ¹ / ₂ " 	finial Ora	35602	60	polished brass	142.90	
			80	antique bronzed	179.90	
¹¹ / ₁₆ " 	end cap	35629	60	polished brass	50.70	
			80	antique bronzed	64.40	
3 ³ / ₅ " — 2 ¹ / ₄ " — 	bracket open	3"	35631	60	polished brass	113.20
		5"	35632	80	antique bronzed	144.10
7 ⁷ / ₉ " — 2 ¹ / ₄ " — 	bracket open	7"	35633	60	polished brass	126.70
				80	antique bronzed	159.80
		9"	35634			
3 ³ / ₅ " 3" — 2 ¹ / ₄ " — 	double bracket open	3"	35641	60	polished brass	183.40
				80	antique bronzed	233.30
		5"	35642			
7 ⁷ / ₉ " 3" — 2 ¹ / ₄ " — 	double bracket open	7"	35643	60	polished brass	196.90
				80	antique bronzed	249.00
		9"	35644			
3 ³ / ₅ " — 2 ¹ / ₄ " — 	bracket with rosette	3"	35671	60	polished brass	207.70
		5"	35672	80	antique bronzed	262.60

brass 1³/₈" dia.

components	part	part-no.	color-no.	price
	bracket with rosette	7"	35673 60 80	polished brass 221.20 antique bronzed 278.30
		9"	35674	
	double bracket with rosette	3"	35681 60 80	polished brass 277.90 antique bronzed 351.80
		5"	35682	
	double bracket with rosette	7"	35683 60 80	polished brass 291.40 antique bronzed 367.50
		9"	35684	
	bracket with rosette Prestige	3"	35771 60 80	polished brass 219.00 antique bronzed 277.00
		5"	35772	
	bracket with rosette Prestige	7"	35773 60 80	polished brass 232.50 antique bronzed 292.70
		9"	35774	
	double bracket with rosette Prestige	3"	35781 60 80	polished brass 289.20 antique bronzed 366.20
		5"	35782	
	double bracket with rosette Prestige	7"	35783 60 80	polished brass 302.70 antique bronzed 381.90
		9"	35784	
	additional distance between rods with double rod e.g. 35641L	L		without surcharge
	ceiling converter for ceiling mounts			see page 454
	extension piece 1"	30719	60 80	polished brass 19.00 antique bronzed 24.10
	extension piece extendable	30619	60 80	polished brass 35.60 antique bronzed 45.20

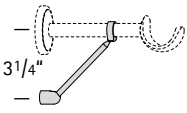
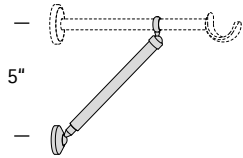
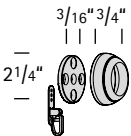
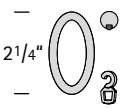
brass 1 3/8" dia.

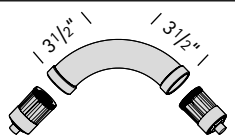
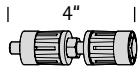
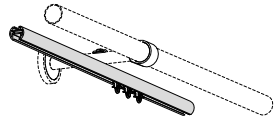
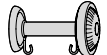
components	part	part-no.	color-no.	price	
	bracket support light duty can be retrofitted	20617	60 80	polished brass antique bronzed	82.20 100.20
	bracket support can be retrofitted	30617	60 80	polished brass antique bronzed	180.70 228.70
	wall socket with anchor clip can be used at both ends	35605	60 80	polished brass antique bronzed	78.80 100.20
	ring 2 1/4" x 1/4" with plastic insert	35709	60 80	polished brass antique bronzed	7.60 9.20
	eyelet clip	10926	50	white	0.20
	elbow 90° any angle cut to measure from 90° to 160° surcharge \$ 56.00 not for fluted tube	35650	60 80	polished brass antique bronzed	177.90 220.60
	tube connector				
	for smooth tube	35659	99		28.20
	for fluted tube	35658	99		28.20
	traversing rod and accessories for extra run			see page 455	
	accessories			see page 443	

ACCESSORIES

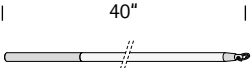
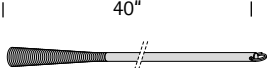
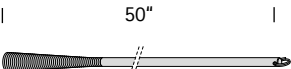
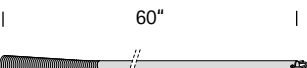
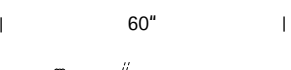

batons	part	part-no.	color-no.	price
 40"	baton 40" material: acrylic glass with metal-grip	10510	90/60 acrylic glass/polished brass	96.50
			90/62 acrylic glass/brushed brass	110.00
			90/71 acrylic glass/polished nickel	110.00
			90/72 acrylic glass/brushed nickel	115.10
 40"	baton 40"	11610	60 polished brass	135.10
			62 brushed brass	162.10
			71 polished nickel	162.10
			72 brushed nickel	172.00
			80 antique bronzed	172.00
 50"	baton 50"	11612	60 polished brass	150.90
			62 brushed brass	181.00
			71 polished nickel	181.00
			72 brushed nickel	192.00
			80 antique bronzed	192.00
 60"	baton 60"	11615	60 polished brass	166.60
			62 brushed brass	199.90
			71 polished nickel	199.90
			72 brushed nickel	212.00
			80 antique bronzed	212.00
 60" color-no. 2	baton 60" can be shortend also in combination, e.g. 62/71 brushed brass/polished nickel	10615	60 polished brass	95.00
			62 brushed brass	98.60
			71 polished nickel	98.60
			72 brushed nickel	104.60
			80 antique bronzed	104.60

ACCESSORIES



one handle can be opened

components

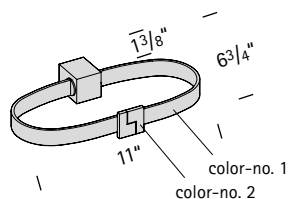

part

holdback
1 3/8" from wall
one handle can be opened

part-no. color-no.

part-no.	color-no.	price
25796	62 brushed brass	349.00
	62/60 brushed brass/polished brass	349.00
	72 brushed nickel	398.50
	72/71 brushed nickel/polished nickel	398.50



one handle can be opened

components

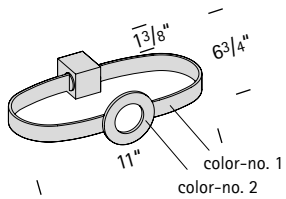

part

holdback
 1 3/8" from wall
 one handle can be opened

part-no.	color-no.	price
25896	62 brushed brass	394.00
	62/60 brushed brass/polished brass	394.00
	72 brushed nickel	448.00
	72/71 brushed nickel/polished nickel	448.00

ACCESSORIES



rosettes:



82091



83591



83592



82086



20991

components

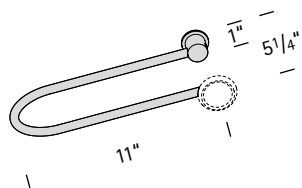

part

holdback (without rosette)

1" from wall
can be shortened
adjustable
without rosette, rosettes see below

part-no. color-no.

part-no.	color-no.	price
30696	60	polished brass
	62	brushed brass
	72	brushed nickel
	80	antique bronzed



rosette

for brass 3/4" dia.
Indigo, Imola, Iris
see page 449



rosette

for brass 1 3/8" dia.
Prestige
see page 450



rosette

for brass 1 3/16" dia.
see page 449



rosette

for brass 3/4" dia.
Hamlet, Julia,
Aida, Cosima
for brass 1 3/16" dia.
Salomo, Saba
see page 451



rosette

for brass 1 3/8" dia.
Odeon, Ora
see page 450

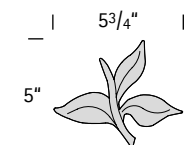

rosette

Silva
see page 451



12796



25696

components

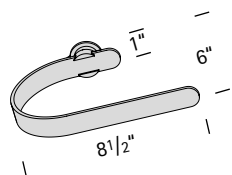

part

holdback
1" from wall
adjustable

part-no. color-no.

part-no.	color-no.	price
25696	51 anthracite	191.40
	60 polished brass	155.40
	62 brushed brass	191.40
	71 polished nickel	191.40
	72 brushed nickel	201.40
	80 antique bronzed	201.40

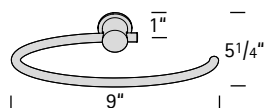

holdback flat
1" from wall
adjustable

part-no.	color-no.	price
12796	60 polished brass	142.90
	62 brushed brass	171.50
	71 polished nickel	171.50
	72 brushed nickel	181.90

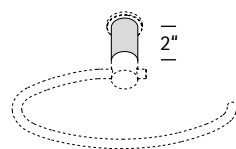

extension piece
2"
for holdbacks
12796, 25696, 30696

part-no.	color-no.	price
30697	51 anthracite	47.30
	60 polished brass	39.40
	62 brushed brass	47.30
	71 polished nickel	47.30
	72 brushed nickel	50.20
	80 antique bronzed	50.20

ACCESSORIES



20687



20993



20692

components	part		part-no.	color-no.	price	
	tieback	3"	20686	60 polished brass	79.40	
					62 brushed brass	95.40
					71 polished nickel	95.40
		5"	20687	72 brushed nickel	101.20	
					80 antique bronzed	101.20
	tieback	7"	20688	60 polished brass	92.90	
					62 brushed brass	111.20
					71 polished nickel	111.20
		9"	20689	72 brushed nickel	116.90	
					80 antique bronzed	116.90
	rosette		82094	60 polished brass	31.50	
					62 brushed brass	37.80
					71 polished nickel	37.80
					72 brushed nickel	40.10
					80 antique bronzed	40.10
	tieback	3"	20992	60 polished brass	86.20	
					62 brushed brass	103.60
					71 polished nickel	103.60
		5"	20993	72 brushed nickel	109.70	
					80 antique bronzed	109.70
	tieback	7"	20994	60 polished brass	99.70	
					62 brushed brass	119.40
					71 polished nickel	119.40
		9"	20995	72 brushed nickel	125.40	
					80 antique bronzed	125.40
	rosette		82092	60 polished brass	38.30	
					62 brushed brass	46.00
					71 polished nickel	46.00
					72 brushed nickel	48.60
					80 antique bronzed	48.60



30692

components	part	part-no.	color-no.	price	
	tieback for brass 3/4" dia. Indigo, Imola, Iris	3"	20691	60 polished brass 62 brushed brass	83.90 100.80
		5"	20692	72 brushed nickel 80 antique bronzed	107.10 107.10
	tieback for brass 3/4" dia. Indigo, Imola, Iris	7"	20693	60 polished brass 62 brushed brass	97.40 116.60
		9"	20694	72 brushed nickel 80 antique bronzed	122.80 122.80
	rosette for brass 3/4" dia. Indigo, Imola, Iris	82091	60 polished brass 62 brushed brass 72 brushed nickel 80 antique bronzed	36.00 43.20 46.00 46.00	
	tieback for brass 13/16" dia.	3"	30691	60 polished brass 61 antique brass 62 brushed brass	116.50 140.10 140.10
		5"	30692	72 brushed nickel 80 antique bronzed	148.60 148.60
	tieback for brass 13/16" dia.	7"	30693	60 polished brass 61 antique brass 62 brushed brass	130.00 155.90 155.90
		9"	30694	72 brushed nickel 80 antique bronzed	164.30 164.30
	rosette for brass 13/16" dia.	83091	60 polished brass 61 antique brass 62 brushed brass 72 brushed nickel 80 antique bronzed	58.50 70.30 70.30 74.50 74.50	

ACCESSORIES



35692



35792



20987

components	part	part-no.	color-no.	price
	tieback for brass 1 ³ / ₈ " dia. Odeon, Ora	3"	35691 60	polished brass 139.00
		5"	35692 80	antique bronzed 177.20
	tieback for brass 1 ³ / ₈ " dia. Odeon, Ora	7"	35693 60	polished brass 152.50
		9"	35694 80	antique bronzed 192.90
	rosette for brass 1 ³ / ₈ " dia. Odeon, Ora	83591	60 80	polished brass 81.00 antique bronzed 103.10
	tieback for brass 1 ³ / ₈ " dia. Prestige	3"	35791 60	polished brass 150.30
		5"	35792 80	antique bronzed 191.60
	tieback for brass 1 ³ / ₈ " dia. Prestige	7"	35793 60	polished brass 163.80
		9"	35794 80	antique bronzed 207.30
	rosette for brass 1 ³ / ₈ " dia. Prestige	83592	60 80	polished brass 92.30 antique bronzed 117.50



ACCESSORIES



20897

components	part	part-no.	color-no.	price	
<p>3 5/8" 2"</p>	tieback for brass 3/4" dia. Hamlet, Julia, Aida, Cosima for brass 1 3/16" dia. Salomo, Saba	3"	20986	51/62 anthracite/brushed brass	180.50
				51/72 anthracite/brushed nickel	221.10
		5"	20987	51/86 anthracite/silver leaf	234.60
				51/87 anthracite/gold leaf	234.60
				60 polished brass	167.20
				60/67 polished brass/brass patina	167.20
				62/67 brushed brass/brass patina	180.50
				72 brushed nickel	225.90
				72/87 brushed nickel/gold leaf	239.40
				72/88 brushed nickel/gold leaf patina	239.40
80 antique bronzed	187.50				
<p>7 9/16" 2"</p>	tieback for brass 3/4" dia. Hamlet, Julia, Aida, Cosima for brass 1 3/16" dia. Salomo, Saba	7"	20988	51/62 anthracite/brushed brass	196.30
				51/72 anthracite/brushed nickel	236.90
		9"	20989	51/86 anthracite/silver leaf	250.40
				51/87 anthracite/gold leaf	250.40
				60 polished brass	180.70
				60/67 polished brass/brass patina	180.70
				62/67 brushed brass/brass patina	196.30
				72 brushed nickel	241.60
				72/87 brushed nickel/gold leaf	255.10
				72/88 brushed nickel/gold leaf patina	255.10
80 antique bronzed	203.20				
<p>2 1/2"</p>	rosette for brass 3/4" dia. Hamlet, Julia, Aida, Cosima for brass 1 3/16" dia. Salomo, Saba	82086	60 polished brass	101.30	
			62 brushed brass	101.30	
			67 brass patina	101.30	
			72 brushed nickel	141.90	
			80 antique bronzed	103.50	
			86 silver leaf	155.40	
			87 gold leaf	155.40	
			88 gold leaf patina	155.40	

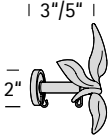
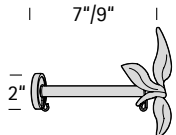
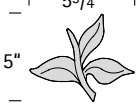
accessories

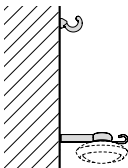
components	part	part-no.	color-no.	price
 3 ³ / ₅ " 2"	tieback for brass 3/4" dia. Silva	3"	20896	60/67 polished brass/brass patina 246.30 62/67 brushed brass/brass patina 261.80 72/88 brushed nickel/gold leaf patina 276.60
		5"	20897	80 antique bronzed 276.60
 7 ⁷ / ₉ " 2"	tieback for brass 3/4" dia. Silva	7"	20898	60/67 polished brass/brass patina 259.80 62/67 brushed brass/brass patina 277.60 72/88 brushed nickel/gold leaf patina 292.30
		9"	20899	80 antique bronzed 292.30
 5 ³ / ₄ " 5"	rosette Silva	20991	67 brass patina 168.90 80 antique bronzed 177.90 88 gold leaf patina 177.90	
 1"	extension piece 1" for tieback	30719	51 anthracite 22.70 60 polished brass 19.00 61 antique brass 22.70 62 brushed brass 22.70 71 polished nickel 22.70 72 brushed nickel 24.10 80 antique bronzed 24.10	
	adapter for finials 3/4" dia. on wall socket 30698 and holdback 30696	82098	60 polished brass 22.50 62 brushed brass 27.00 71 polished nickel 27.00 72 brushed nickel 28.60 80 antique bronzed 28.60	
	wall socket for rosettes 82094, 82092, 82091 83091, 83591, 83592, 82086	30698	60 polished brass 43.90 71 polished nickel 52.70 80 antique bronzed 55.80	

ACCESSORIES





30891

components	part	part-no.	color-no.	price	
	hook for trimmings 1" from wall	30891	60	polished brass	94.50
			62	brushed brass	113.50
			71	polished nickel	113.50
			72	brushed nickel	120.20
			80	antique bronzed	120.20
	hook for trimmings 3 ³ / ₄ " from wall can be shortened	30892	60	polished brass	108.10
			62	brushed brass	129.60
			71	polished nickel	129.60
			72	brushed nickel	137.60
			80	antique bronzed	137.60

ACCESSORIES

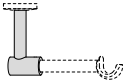
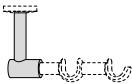
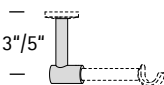
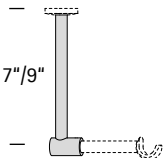

ceiling converter	part	part-no.	color-no.	price
brass brackets can be converted for ceiling mounts using the ceiling converter				
	single rod	e.g. ceiling converter bracket	30711 30631	
	double rod	e.g. ceiling converter bracket	30712 20641	
	ceiling converter	3"	30711	51 anthracite 71.10 60 polished brass 59.20 62 brushed brass 71.10 71 polished nickel 71.10 72 brushed nickel 75.40 80 antique bronzed 75.40
	ceiling converter	7"	30713	51 anthracite 86.90 60 polished brass 72.60 62 brushed brass 86.90 71 polished nickel 86.90 72 brushed nickel 91.10 80 antique bronzed 91.10
	extension piece 1" for ceiling converter		30719	51 anthracite 22.70 60 polished brass 19.00 62 brushed brass 22.70 71 polished nickel 22.70 72 brushed nickel 24.10 80 antique bronzed 24.10

accessories

finishes available

- A** 56 black
62 brushed brass
72 brushed nickel
80 antique bronzed

- B** 60 polished brass
71 polished nickel
77 stainless steel

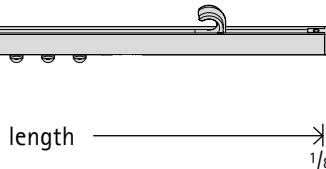

material: aluminium

traversing rod

	length (ft.)	rollers	holder	material: aluminium		
				A	B	
 length → 1/8"	3	16	2	\$ 84	95	
	4	20	2	102	116	
	5	24	3	125	144	
	6	30	3	145	167	
	7	34	3	163	189	
	8	40	3	183	212	
	9	44	4	206	240	
	• 10	50	4	226	263	
	11	54	4	244	285	
	12	60	4	263	308	
	13	64	4	281	330	
	set-no. 02832	14	68	5	305	357
		15	74	5	325	380
		16	78	5	343	402
		17	84	5	362	425
		18	88	5	380	447
		surcharge per wall socket			+38	+52

- rods in excess of 9ft. will be delivered in two sections

components traversing rod

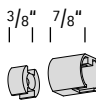
	part	part-no.	color-no.	price
	traversing rod 3/4" material: aluminium	30570	56 black	Cut to measure \$ / lin ft. 14.80
			60 polished brass	18.50
			62 brushed brass	14.80
			71 polished nickel	18.50
			72 brushed nickel	14.80
			77 stainless steel	18.50
			80 antique bronzed	14.80
				holder for traversing rod
60 polished brass (also for color 62)	5.70			
71 polished nickel (also for color 72, 77)	5.70			
80 antique bronzed	5.70			
	end cap	21829	56 black	5.70
			60 polished brass (also for color 62)	5.70
			71 polished nickel (also for color 72, 77)	5.70
			80 antique bronzed	5.70
	wall socket can be used at both ends	21705	56 black	49.50
			60 polished brass	63.00
			62 brushed brass	49.50
			71 polished nickel	63.00
			72 brushed nickel	49.50
			77 stainless steel	63.00
			80 antique bronzed	49.50

accessories

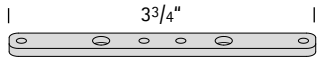
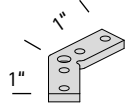
components	part	part-no.	color-no.	price
	roller with eyelet	30082	50 white	0.80
	curtain hook	30080	50 white	0.20
	runner for batons can be retrofitted	30078	50 white	3.60
	stop clamp	30089	50 white	1.80
	connector	30579	99	16.90
	corner connector 90°	30550	99	25.90
	corner connector 135°	30551	99	30.40
	corner connector flexible	30552	99	59.70

page 462

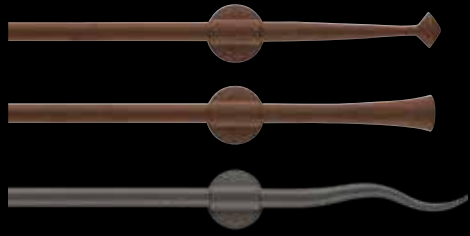

page 468

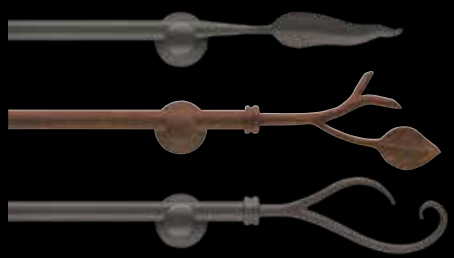

page 472



iron

5/8" dia.



prolog anthracite



epilog anthracite



dialog rust



holdback rust p. 505

finishes available

51 anthracite

81 rust

prolog 81 rust



epilog 81 rust



dialog 51 anthracite



scale 1:1



iron 5/8" dia.

finishes available

- 51 anthracite
- 81 rust

single rod

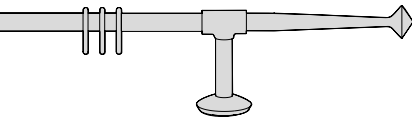

length →

 **Prolog**

set-no.

01571

 **Epilog**

01572

 **Dialog**

01573

length *rings brackets

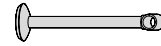

brackets 3" or 5"

brackets 7" or 9"



integral

(ft.)

brackets surcharge

	3	14	2	\$	358	385	2	252	
	4	18	2		384	411	2	261	
	5	22	3		488	528	2	192	
	6	26	3		513	554	2	201	
	7	30	3		539	580	2	210	
	8	34	3		565	606	2	219	
	9	38	4		669	723	3	341	
•	10	42	4		694	748	3	350	
	11	48	4		728	782	3	359	
	12	52	4		754	808	3	368	
	13	56	4		780	834	3	377	
	14	60	5		884	951	3	308	
	15	64	5		909	977	3	317	
	16	68	5		935	1003	3	326	
	17	72	5		961	1029	3	335	
	18	76	5		987	1054	3	344	
	reduction per wall socket					85	98		

double rod

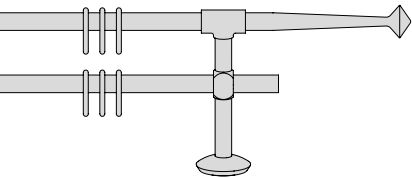

length →

 **Prolog**

set-no.

01574

 **Epilog**

01575

 **Dialog**

01576

length *rings brackets

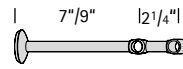
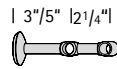

brackets 3" or 5"

brackets 7" or 9"



integral

(ft.)

brackets surcharge

	3	28	2	\$	620	647	2	504	
	4	36	2		672	699	2	522	
	5	44	3		865	906	2	398	
	6	52	3		917	958	2	416	
	7	60	3		969	1009	2	434	
	8	68	3		1020	1061	2	452	
	9	76	4		1214	1268	3	696	
•	10	84	4		1265	1319	3	714	
	11	96	4		1333	1387	3	732	
	12	104	4		1385	1439	3	750	
	13	112	4		1436	1490	3	768	
	14	120	5		1630	1697	3	644	
	15	128	5		1681	1749	3	662	
	16	136	5		1733	1801	3	680	
	17	144	5		1785	1852	3	698	
	18	152	5		1836	1904	3	716	
	reduction per wall socket					121	135		

Notes

* rings with plastic inserts





accessories



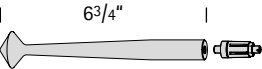
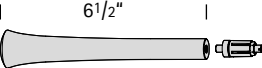
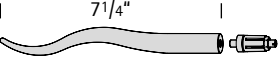
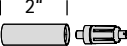
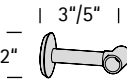
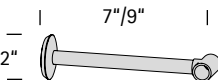
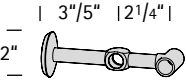
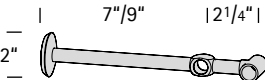

see page 505

• rods in excess of 9ft. will be delivered in two sections

iron 5/8" dia.

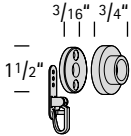
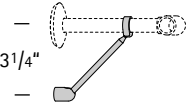
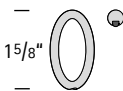
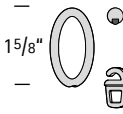
components	part	part-no.	color-no.	price	
	iron tube 5/8" dia. laquered	16810	51 81	anthracite rust <small>Cut to measure \$/lin.ft.</small>	9.40 9.40
	finial Prolog	16881	51 81	anthracite rust	58.50 58.50
	finial Epilog	16882	51 81	anthracite rust	58.50 58.50
	finial Dialog	16883	51 81	anthracite rust	58.50 58.50
	end cap for double rod	16879	51 81	anthracite rust	24.30 24.30
	bracket	3" 16851	51 81	anthracite rust	77.80 77.80
		5" 16852			
	bracket	7" 16853	51 81	anthracite rust	91.30 91.30
		9" 16854			
	double bracket	3" 16861	51 81	anthracite rust	141.80 141.80
		5" 16862			
	double bracket	7" 16863	51 81	anthracite rust	155.30 155.30
		9" 16864			
	extension piece 1"	30719	51 81	anthracite rust	22.70 22.70

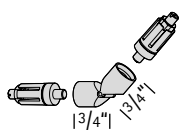
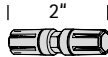
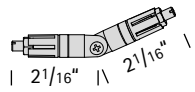
iron 5/8" dia.

components	part	part-no.	color-no.	price	
	wall socket with anchor clip can be used at both ends	16705	51 81	anthracite rust	51.80 51.80
	bracket support can be retrofitted	20617	51 81	anthracite rust	82.20 82.20
	ring 1 5/8" x 3/16" with plastic insert	20879	51 81	anthracite rust	3.90 3.90
	ring 1 5/8" x 3/16" with eyelet clip with plastic insert	20878	51 81	anthracite rust	4.10 4.10
	eyelet clip	10921	50	white	0.20
	swivel joint	16651	51 81	anthracite rust	108.10 108.10
	tube connector	16659	99		16.90
	mitre connector for any angle mitre cut \$ 43.00	16653	99		87.80
	traversing rod and accessories for extra run			see page 519	
	accessories			see page 505	



piazza rust



lago rust



finca anthracite



toscana anthracite

tiebacks rust p. 507



finishes available

51 anthracite

81 rust

lago 51 anthracite



toscana 81 rust



casa 51 anthracite



scale 1:1



iron 5/8" dia.

finishes available

- 51 anthracite
- 81 rust

single rod

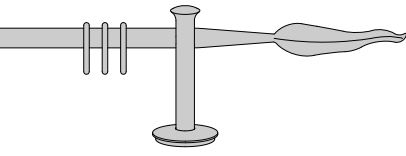

length → 7" |

 **Lago**

set-no.
01709

length (ft.)	*rings	brackets	bracket 3"	bracket 5"
3	14	2	\$ 273	293
4	18	2	299	319
5	22	3	379	409
6	26	3	405	434
7	30	3	431	460
8	34	3	457	486
9	38	4	537	576
• 10	42	4	563	602
11	48	4	597	636
12	52	4	622	662
13	56	4	648	687
14	60	5	728	777
15	64	5	754	803
16	68	5	780	829
17	72	5	806	855
18	76	5	832	881
reduction per wall socket			42	52

double rod

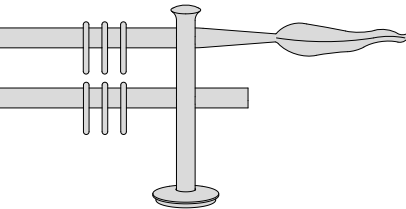

length → 7" |

 **Lago**

set-no.
01719

length (ft.)	*rings	brackets	bracket 3"
3	28	2	\$ 456
4	36	2	508
5	44	3	638
6	52	3	690
7	60	3	741
8	68	3	793
9	76	4	923
• 10	84	4	975
11	96	4	1043
12	104	4	1095
13	112	4	1146
14	120	5	1277
15	128	5	1328
16	136	5	1380
17	144	5	1431
18	152	5	1483
reduction per wall socket			39

Notes



* rings with plastic inserts

accessories

see page 505

• rods in excess of 9ft. will be delivered in two sections



iron 5/8" dia.

finishes available

- 51 anthracite
- 81 rust

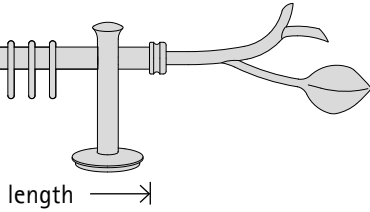
single rod





	set-no.	
	Toscana	01710
	Casa	01713

length	*rings	brackets	bracket 3"	bracket 5"	integral
(ft.)					brackets surcharge
3	14	2	\$ 298	318	2 252
4	18	2	324	343	2 261
5	22	3	404	433	2 216
6	26	3	430	459	2 225
7	30	3	456	485	2 234
8	34	3	481	511	2 243
9	38	4	562	601	3 365
• 10	42	4	587	627	3 374
11	48	4	621	661	3 383
12	52	4	647	686	3 392
13	56	4	673	712	3 401
14	60	5	753	802	3 355
15	64	5	779	828	3 364
16	68	5	805	854	3 373
17	72	5	831	880	3 382
18	76	5	856	905	3 391
reduction per wall socket			54	64	

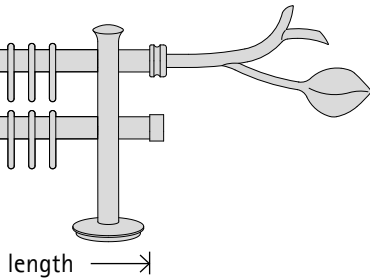
double rod



	set-no.	
	Toscana	01720
	Casa	01723

length	*rings	brackets	bracket 3"	bracket 5"	integral
(ft.)					brackets surcharge
3	28	2	\$ 481		2 504
4	36	2	533		2 522
5	44	3	663		2 461
6	52	3	715		2 479
7	60	3	766		2 497
8	68	3	818		2 515
9	76	4	948		3 759
• 10	84	4	1000		3 777
11	96	4	1068		3 795
12	104	4	1119		3 813
13	112	4	1171		3 831
14	120	5	1301		3 770
15	128	5	1353		3 788
16	136	5	1405		3 806
17	144	5	1456		3 824
18	152	5	1508		3 842
reduction per wall socket			51		

Notes



* rings with plastic inserts

accessories

see page 505

• rods in excess of 9ft. will be delivered in two sections

components see page 475

finishes available

51 anthracite

81 rust

piazza 51 anthracite



finca 81 rust



tivoli 81 rust



scale 1:1



iron 5/8" dia.

finishes available

- 51 anthracite
- 81 rust

single rod

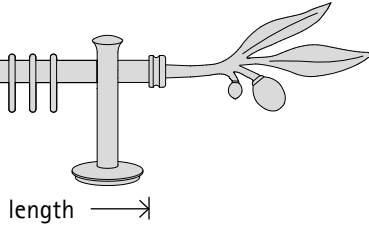

	set-no.	
	Piazza	01714
	Finca	01717
	Tivoli	01718

length (ft.)	*rings	brackets	bracket 3"	bracket 5"	integral
3	14	2	\$ 298	318	brackets surcharge 2 252
4	18	2	324	343	2 261
5	22	3	404	433	2 216
6	26	3	430	459	2 225
7	30	3	456	485	2 234
8	34	3	481	511	2 243
9	38	4	562	601	3 365
• 10	42	4	587	627	3 374
11	48	4	621	661	3 383
12	52	4	647	686	3 392
13	56	4	673	712	3 401
14	60	5	753	802	3 355
15	64	5	779	828	3 364
16	68	5	805	854	3 373
17	72	5	831	880	3 382
18	76	5	856	905	3 391
reduction per wall socket			54	64	

double rod

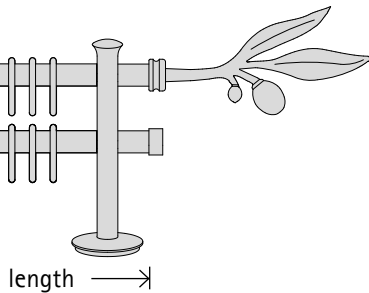

	set-no.	
	Piazza	01724
	Finca	01727
	Tivoli	01728

length (ft.)	*rings	brackets	bracket 3"	bracket 5"	integral
3	28	2	\$ 481		brackets surcharge 2 504
4	36	2	533		2 522
5	44	3	663		2 461
6	52	3	715		2 479
7	60	3	766		2 497
8	68	3	818		2 515
9	76	4	948		3 759
• 10	84	4	1000		3 777
11	96	4	1068		3 795
12	104	4	1119		3 813
13	112	4	1171		3 831
14	120	5	1301		3 770
15	128	5	1353		3 788
16	136	5	1405		3 806
17	144	5	1456		3 824
18	152	5	1508		3 842
reduction per wall socket			51		

Notes







* rings with plastic inserts

accessories

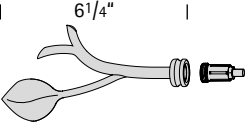
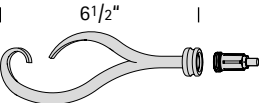
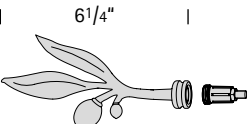
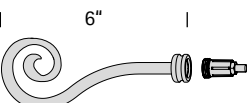
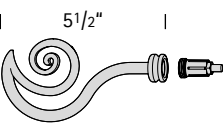

see page 505

• rods in excess of 9ft. will be delivered in two sections

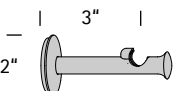
iron 5/8" dia.

components	part	part-no.	color-no.	price
	iron tube 5/8" dia. laquered	16810	51 81	anthracite rust <small>Cut to measure \$/lin.ft.</small> 9.40 9.40
	finial Lago	16871	51 81	anthracite rust 39.40 39.40
	finial Toscana	16872	51 81	anthracite rust 51.80 51.80
	finial Casa	16873	51 81	anthracite rust 51.80 51.80
	finial Piazza	16874	51 81	anthracite rust 51.80 51.80
	finial Finca	16876	51 81	anthracite rust 51.80 51.80
	finial Tivoli	16877	51 81	anthracite rust 51.80 51.80
	finial for double rod Lago	16879	51 81	anthracite rust 24.30 24.30
	end cap	16829	51 81	anthracite rust 24.30 24.30
	bracket 3" can be shortened	16831	51 81	anthracite rust 54.40 54.40

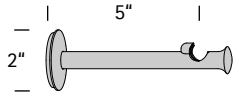
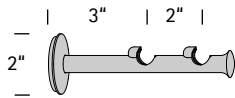
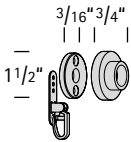
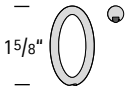
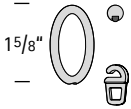
iron 5/8" dia.

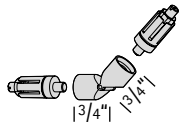
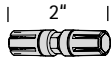
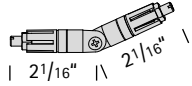
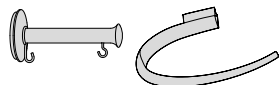
components	part	part-no.	color-no.	price
	bracket 5" can be shortened	16832	51 81	anthracite rust 64.20 64.20
	double bracket 3" can be shortened	16841	51 81	anthracite rust 78.80 78.80
	wall socket with anchor clip can be used at both ends	16705	51 81	anthracite rust 51.80 51.80
	ring 1 5/8" x 3/16" with plastic insert	20879	51 81	anthracite rust 3.90 3.90
	ring 1 5/8" x 3/16" with eyelet clip with plastic insert	20878	51 81	anthracite rust 4.10 4.10
	eyelet clip	10921	50	white 0.20
	swivel joint	16651	51 81	anthracite rust 108.10 108.10
	tube connector	16659	99	16.90
	mitre connector for any angle mitre cut \$ 43.00	16653	99	87.80
	accessories	see page 505		

page 478



page 482



page 488

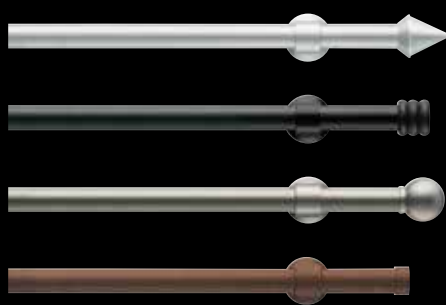

iron

3/4"
dia.



hellas iron



athos rust



olivia black/gold





finishes available

56 black

68 silver

74 iron

81 rust

69 gold (finials only)

olivia 56/68 black/silver



hellas 81 rust



athos 74 iron





iron 3/4" dia.

finishes available

56	black	81	rust
56/68	black/silver	81/68	rust/silver
56/69	black/gold	81/69	rust/gold
74	iron	68	silver
74/68	iron/silver	68/69	silver/gold
74/69	iron/gold		

single rod

□ color no. 1
■ color no. 2

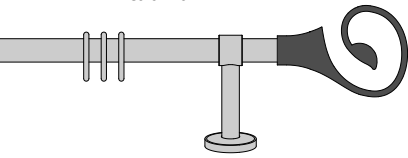

length →

	Athos	02300
	Olivia	02302
	Hellas	02303

set-no.

length (ft.)	*rings	brackets	bracket 3" bracket 7"		integral	brackets surcharge
3	14	2	\$ 280	303	2	278
4	18	2	306	329	2	288
5	22	3	380	413	2	251
6	26	3	406	439	2	261
7	30	3	432	465	2	271
8	34	3	458	492	2	281
9	38	4	531	576	2	243
• 10	42	4	557	602	3	425
11	48	4	592	637	3	435
12	52	4	618	663	3	445
13	56	4	644	689	3	455
14	60	5	717	773	3	417
15	64	5	743	799	3	427
16	68	5	770	826	3	437
17	72	5	796	852	3	447
18	76	5	822	878	3	457
reduction per wall socket			42	53		

double rod

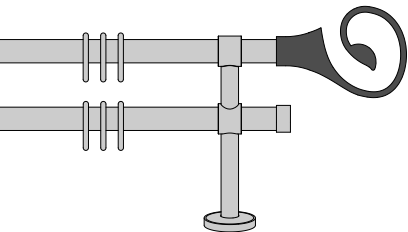

length →

	Athos	02305
	Olivia	02307
	Hellas	02308

set-no.

length (ft.)	*rings	brackets	bracket 3" bracket 7"		integral	brackets surcharge
3	28	2	\$ 466	482	2	556
4	36	2	518	534	2	576
5	44	3	641	665	2	525
6	52	3	694	717	2	545
7	60	3	746	769	2	565
8	68	3	798	822	2	585
9	76	4	921	953	2	534
• 10	84	4	973	1005	3	873
11	96	4	1042	1073	3	893
12	104	4	1094	1126	3	913
13	112	4	1146	1178	3	933
14	120	5	1269	1309	3	882
15	128	5	1322	1361	3	902
16	136	5	1374	1413	3	922
17	144	5	1426	1465	3	942
18	152	5	1478	1518	3	962
reduction per wall socket			36	44		

Notes

* rings with plastic inserts



accessories

see page 505

• rods in excess of 9ft. will be delivered in two sections



legato black/brushed nickel



staccato black/polished nickel



jazz black/brushed brass



finishes available

56 black

68 silver

74 iron

81 rust

set without finials



finials



akzent



fox



atlas



swing



areal



jazz



grazioso



legato



staccato

finishes finials



60 polished brass



62 brushed brass



71 polished nickel



72 brushed nickel



80 antique bronzed

iron 3/4" dia.

finishes available

- 56 black
- 68 silver
- 74 iron
- 81 rust

single rod

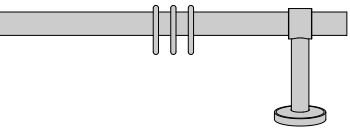



length →

set-no.

without finials 02398

set without finials
finials see page 485

length (ft.)	*rings	brackets		 bracket 3"	 bracket 7"	 integral	brackets	surcharge
3	14	2	\$	181	204		2	278
4	18	2		207	230		2	288
5	22	3		281	314		2	251
6	26	3		307	340		2	261
7	30	3		333	366		2	271
8	34	3		359	393		2	281
9	38	4		432	477		2	243
• 10	42	4		458	503		3	425
11	48	4		493	538		3	435
12	52	4		519	564		3	445
13	56	4		545	590		3	455
14	60	5		618	674		3	417
15	64	5		644	700		3	427
16	68	5		671	727		3	437
17	72	5		697	753		3	447
18	76	5		723	779		3	457
surcharge/reduction per wall socket				+8	3			

double rod

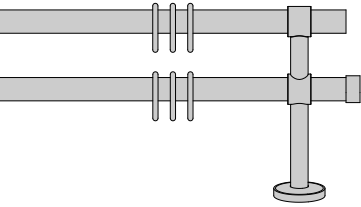



length →

set-no.

without finials 02399

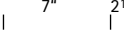
set without finials
finials see page 485

length (ft.)	*rings	brackets		 bracket 3"	 bracket 7"	 integral	brackets	surcharge
3	28	2	\$	367	383		2	556
4	36	2		419	435		2	576
5	44	3		542	566		2	525
6	52	3		595	618		2	545
7	60	3		647	670		2	565
8	68	3		699	723		2	585
9	76	4		822	854		2	534
• 10	84	4		874	906		3	873
11	96	4		943	974		3	893
12	104	4		995	1027		3	913
13	112	4		1047	1079		3	933
14	120	5		1170	1210		3	882
15	128	5		1223	1262		3	902
16	136	5		1275	1314		3	922
17	144	5		1327	1366		3	942
18	152	5		1379	1419		3	962
surcharge per wall socket				+13	+5			

Notes

* rings with plastic inserts



accessories

see page 505

• rods in excess of 9ft. will be delivered in two sections

iron 3/4" dia.

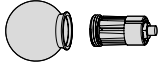
components	finial	part-no.	color-no.	price
1 7/8" 	Fox	22601		
1 5/8" 	Swing	22602	60 polished brass 62 brushed brass 71 polished nickel 72 brushed nickel 80 antique bronzed	52.90 63.40 63.40 67.30 67.30
2" 	Jazz	22603		
1 3/4" 	Atlas	20704		
1" 	Areal	20804	60 polished brass 62 brushed brass 71 polished nickel 72 brushed nickel 80 antique bronzed	67.50 81.00 81.00 86.00 86.00
2 1/4" 	Akzent	20604		
2 3/4" 	Legato	20901		
2 1/4" 	Grazioso	20902	60 polished brass 62 brushed brass 71 polished nickel 72 brushed nickel	117.10 140.50 140.50 148.80
2 1/2" 	Staccato	20903		



ergo silver



puck black



riva rust



finishes available

56 black

68 silver

74 iron

81 rust

ergo 68 silver

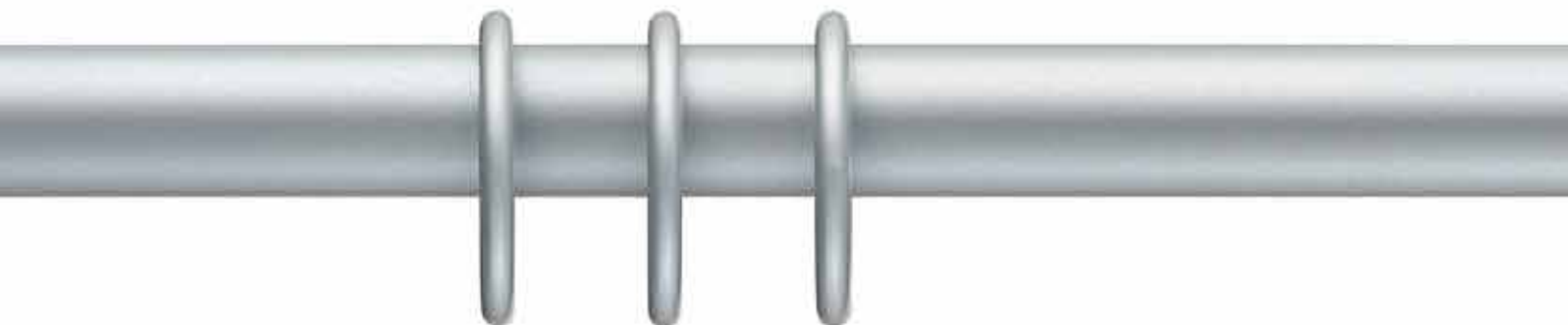

riva 56 black



puck 74 iron



basis 81 rust



scale 1:1



iron 3/4" dia.

finishes available

- 56 black
- 68 silver
- 74 iron
- 81 rust

single rod

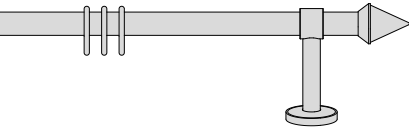

length →

set-no.

- Ergo** 02360
- Riva** 02361
- Puck** 02366

length (ft.)	*rings	brackets		bracket 3"	bracket 7"	integral	brackets surcharge
3	14	2	\$	249	271	2	278
4	18	2		275	297	2	288
5	22	3		348	382	2	251
6	26	3		374	408	2	261
7	30	3		400	434	2	271
8	34	3		427	460	2	281
9	38	4		500	545	2	243
• 10	42	4		526	571	3	425
11	48	4		560	605	3	435
12	52	4		586	631	3	445
13	56	4		613	657	3	455
14	60	5		686	742	3	417
15	64	5		712	768	3	427
16	68	5		738	794	3	437
17	72	5		764	820	3	447
18	76	5		790	846	3	457
reduction per wall socket				26	37		

double rod

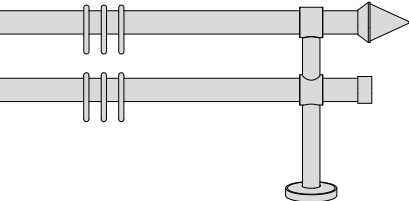

length →

set-no.

- Ergo** 02363
- Riva** 02364
- Puck** 02367

length (ft.)	*rings	brackets		bracket 3"	bracket 7"	integral	brackets surcharge
3	28	2	\$	435	450	2	556
4	36	2		487	503	2	576
5	44	3		610	634	2	525
6	52	3		662	686	2	545
7	60	3		714	738	2	565
8	68	3		767	790	2	585
9	76	4		890	921	2	534
• 10	84	4		942	973	3	873
11	96	4		1010	1042	3	893
12	104	4		1063	1094	3	913
13	112	4		1115	1146	3	933
14	120	5		1238	1277	3	882
15	128	5		1290	1330	3	902
16	136	5		1342	1382	3	922
17	144	5		1395	1434	3	942
18	152	5		1447	1486	3	962
reduction per wall socket				20	28		

Notes



* rings with plastic inserts

accessories

see page 505

• rods in excess of 9ft. will be delivered in two sections

iron 3/4" dia.

finishes available

- 56 black
- 68 silver
- 74 iron
- 81 rust

single rod

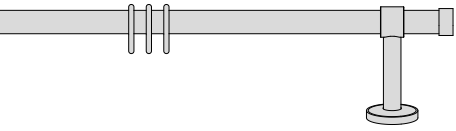

length → $\frac{1}{2}$ "

set-no.

□ **Basis** 02362

length (ft.)	*rings	brackets	bracket 3"	bracket 7"	brackets	surcharge
3	14	2	\$ 233	256	2	278
4	18	2	259	282	2	288
5	22	3	333	366	2	251
6	26	3	359	393	2	261
7	30	3	385	419	2	271
8	34	3	411	445	2	281
9	38	4	485	529	2	243
• 10	42	4	511	555	3	425
11	48	4	545	590	3	435
12	52	4	571	616	3	445
13	56	4	597	642	3	455
14	60	5	671	727	3	417
15	64	5	697	753	3	427
16	68	5	723	779	3	437
17	72	5	749	805	3	447
18	76	5	775	831	3	457
reduction per wall socket			18	29		

double rod

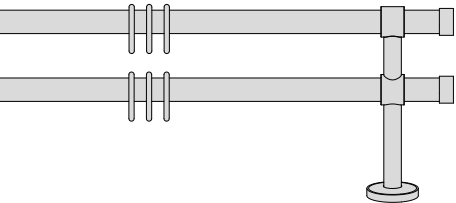

length → $\frac{1}{2}$ "

set-no.

□ **Basis** 02365

length (ft.)	*rings	brackets	bracket 3"	bracket 7"	brackets	surcharge
3	28	2	\$ 419	435	2	556
4	36	2	471	487	2	576
5	44	3	595	618	2	525
6	52	3	647	670	2	545
7	60	3	699	723	2	565
8	68	3	751	775	2	585
9	76	4	874	906	2	534
• 10	84	4	926	958	3	873
11	96	4	995	1027	3	893
12	104	4	1047	1079	3	913
13	112	4	1099	1131	3	933
14	120	5	1223	1262	3	882
15	128	5	1275	1314	3	902
16	136	5	1327	1366	3	922
17	144	5	1379	1419	3	942
18	152	5	1431	1471	3	962
reduction per wall socket			13	21		

Notes



* rings with plastic inserts

accessories

see page 505



• rods in excess of 9ft. will be delivered in two sections

components see page 492

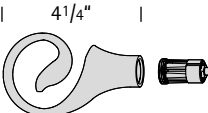
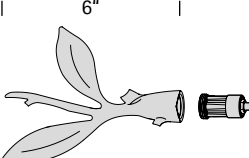
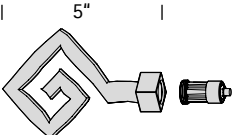
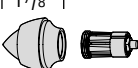
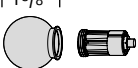
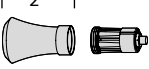
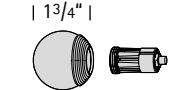
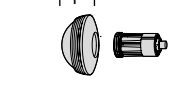
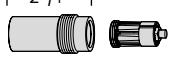
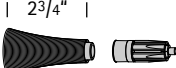
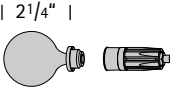
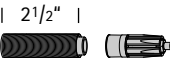

iron 3/4" dia.

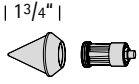
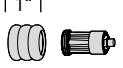
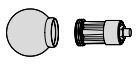
components	part	part-no.	color-no.	price
	iron tube 3/4" dia. laquered	20810	56 black 68 silver 74 iron 81 rust	Cut to measure \$/ lin. ft. 9.70 9.70 9.70 9.70
	finial Athos	20871		
	Olivia	20875	56 black 68 silver 69 gold 74 iron 81 rust	49.50 49.50 49.50 49.50 49.50
	Hellas	20872		
	finial Fox	22601		
	Swing	22602	60 polished brass 62 brushed brass 71 polished nickel 72 brushed nickel 80 antique bronzed	52.90 63.40 63.40 67.30 67.30
	Jazz	22603		
	finial Atlas	20704		
	Areal	20804	60 polished brass 62 brushed brass 71 polished nickel 72 brushed nickel 80 antique bronzed	67.50 81.00 81.00 86.00 86.00
	Akzent	20604		
	finial Legato	20901		
	Grazioso	20902	60 polished brass 62 brushed brass 71 polished nickel 72 brushed nickel	117.10 140.50 140.50 148.80
	Staccato	20903		

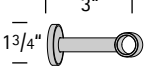
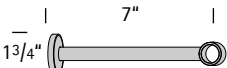
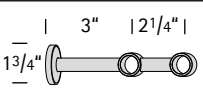
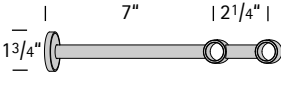
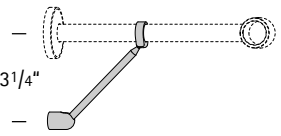
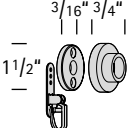
iron 3/4" dia.

components	part	part-no.	color-no.	price
 <p> 1 3/4" </p>	finial Ergo	20865		
 <p> 1" </p>	Riva	20866	56 black 68 silver 74 iron 81 rust	33.80 33.80 33.80 33.80
 <p> 1 1/2" </p>	Puck	20868		
 <p>1/2" </p>	end cap Basis	20829	56 black 68 silver 74 iron 81 rust	26.10 26.10 26.10 26.10
 <p>3" 1 3/4"</p>	bracket 3" can be shortened	20811	56 black 68 silver 74 iron 81 rust	47.30 47.30 47.30 47.30
 <p>7" 1 3/4"</p>	bracket 7" can be shortened	20812	56 black 68 silver 74 iron 81 rust	58.50 58.50 58.50 58.50
 <p>3" 2 1/4" 1 3/4"</p>	double bracket 3" can be shortened	20821	56 black 68 silver 74 iron 81 rust	70.90 70.90 70.90 70.90
 <p>7" 2 1/4" 1 3/4"</p>	double bracket 7" can be shortened	20822	56 black 68 silver 74 iron 81 rust	78.80 78.80 78.80 78.80
 <p>3 1/4"</p>	bracket support can be retrofitted	20617	56 black 68 silver 74 iron 81 rust	82.20 82.20 82.20 82.20
 <p>3/16" 3/4" 1 1/2"</p>	wall socket with anchor clip can be used at both ends	20705	56 black 68 silver 74 iron 81 rust	55.20 55.20 55.20 55.20

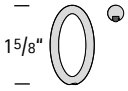
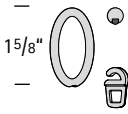
iron 3/4" dia.

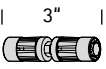
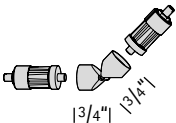
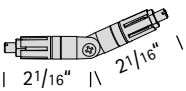
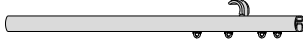
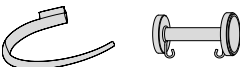
components	part	part-no.	color-no.	price
 1 5/8"	ring 1 5/8" x 3/16" with plastic insert	20879	56 black	3.90
			68 silver	3.90
			74 iron	3.90
			81 rust	3.90
 1 5/8"	ring 1 5/8" x 3/16" with eyelet clip with plastic insert	20878	56 black	4.10
			68 silver	4.10
			74 iron	4.10
			81 rust	4.10
 1/2"	eyelet clip	10921	50 white	0.20
 3"	tube connector	20659	99	18.60
 1 3/4" 1 3/4"	swivel joint	20651	56 black	123.90
			68 silver	123.90
			74 iron	123.90
			81 rust	123.90
 2 1/16" 2 1/16"	mitre connector for any angle mitre cut \$ 43.00	20653	99	87.80
	traversing rod and accessories for extra run	see page 519		
	accessories	see page 505		

page 496

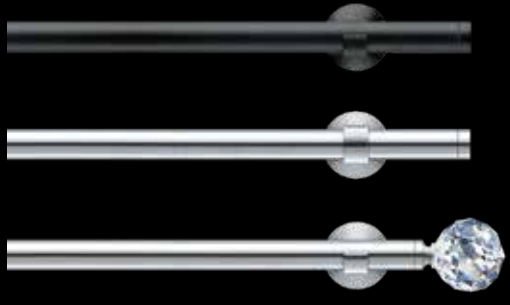

page 500

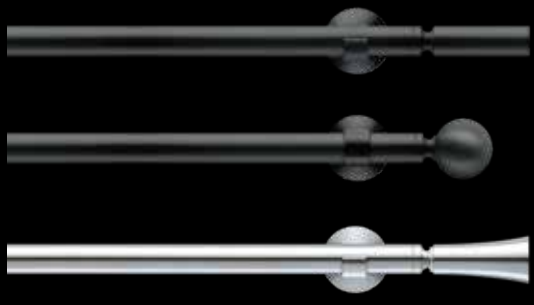

iron

1" dia.



wimbledon black



madison black/crystal glass hand cut



hampton stainless steel



tieback black p. 506



finishes available

56 black

77 stainless steel

hampton 56 black



hampton 77 stainless steel



madison 77/98 stainless steel/crystal glass hand cut



scale 1:1



iron 1" dia.

finishes available

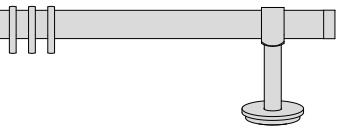

- A 56 black
- B 77 stainless steel

single rod



length \rightarrow $\frac{3}{8}$ "

Hampton set-no.

-  bracket closed 02605
-  bracket open 02615

length (ft.)	*rings	brackets		brackets 3" or 5"		brackets 7" or 9"		integral	
				A	B	A	B	brackets	surcharge
3	14	2	\$	356	423	383	454	2	306
4	18	2		386	459	413	491	2	318
5	22	2		417	496	444	527	2	330
6	26	3		542	643	582	691	2	248
7	30	3		572	680	613	727	2	260
8	34	3		603	716	643	764	2	272
9	38	3		633	753	674	800	2	284
• 10	42	3		664	789	704	837	3	525
11	48	4		797	947	851	1010	3	443
12	52	4		828	983	882	1047	3	455
13	56	4		858	1020	912	1083	3	467
14	60	4		889	1056	943	1120	3	479
15	64	4		919	1093	973	1156	3	491
16	68	4		950	1129	1004	1193	3	503
17	72	5		1075	1277	1142	1356	3	421
18	76	5		1105	1314	1173	1393	3	433
reduction per wall socket				77	95	91	111		

double rod

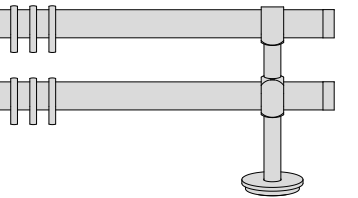

length \rightarrow $\frac{3}{8}$ "

Hampton set-no.

-  bracket closed 02610

length (ft.)	*rings	brackets		brackets 3" or 5"		brackets 7" or 9"		integral	
				A	B	A	B	brackets	surcharge
3	28	2	\$	631	750	658	781	2	612
4	36	2		692	823	719	854	2	636
5	44	2		753	896	780	927	2	660
6	52	3		962	1143	1002	1191	2	537
7	60	3		1023	1216	1063	1264	2	561
8	68	3		1084	1289	1124	1337	2	585
9	76	3		1145	1362	1186	1410	2	609
• 10	84	3		1206	1435	1247	1483	3	1050
11	96	4		1432	1702	1486	1765	3	927
12	104	4		1493	1775	1547	1838	3	951
13	112	4		1554	1848	1608	1911	3	975
14	120	4		1616	1921	1670	1984	3	999
15	128	4		1677	1994	1731	2057	3	1023
16	136	4		1738	2067	1792	2130	3	1047
17	144	5		1947	2315	2014	2394	3	923
18	152	5		2008	2388	2075	2467	3	947
reduction per wall socket				114	143	127	159		

Notes

* rings with plastic inserts



accessories

see page 505

• rods in excess of 9ft. will be delivered in two sections

iron 1" dia.

finishes available

A 56/98 black/crystal glass hand cut

B 77/98 stainless steel/crystal glass hand cut

single rod

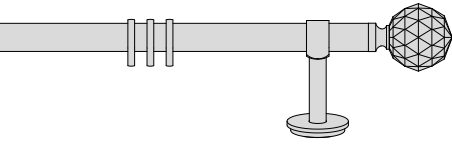

length → 3" |

Madison set-no.

 bracket closed 02604

 bracket open 02614

length (ft.)	*rings	brackets	brackets 3" or 5"		brackets 7" or 9"		integral	
			A	B	A	B	brackets	surcharge
3	14	2	\$ 826	893	853	925	2	306
4	18	2	857	930	884	961	2	318
5	22	2	888	966	915	998	2	330
6	26	3	1012	1114	1053	1161	2	248
7	30	3	1043	1151	1083	1198	2	260
8	34	3	1073	1187	1114	1234	2	272
9	38	3	1104	1224	1144	1271	2	284
• 10	42	3	1135	1260	1175	1307	3	525
11	48	4	1268	1418	1322	1481	3	443
12	52	4	1298	1454	1352	1517	3	455
13	56	4	1329	1491	1383	1554	3	467
14	60	4	1359	1527	1413	1590	3	479
15	64	4	1390	1564	1444	1627	3	491
16	68	4	1421	1600	1475	1663	3	503
17	72	5	1545	1748	1613	1827	3	421
18	76	5	1576	1784	1643	1863	3	433
reduction per wall socket			312	331	326	347		

double rod

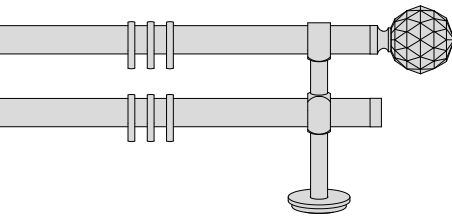

length → 3" |

Madison set-no.

 bracket closed 02609

length (ft.)	*rings	brackets	brackets 3" or 5"		brackets 7" or 9"		integral	
			A	B	A	B	brackets	surcharge
3	28	2	\$ 1101	1220	1128	1252	2	612
4	36	2	1162	1293	1189	1325	2	636
5	44	2	1224	1366	1251	1398	2	660
6	52	3	1432	1614	1473	1661	2	537
7	60	3	1493	1687	1534	1734	2	561
8	68	3	1555	1760	1595	1807	2	585
9	76	3	1616	1833	1656	1880	2	609
• 10	84	3	1677	1906	1717	1953	3	1050
11	96	4	1903	2173	1957	2236	3	927
12	104	4	1964	2246	2018	2309	3	951
13	112	4	2025	2319	2079	2382	3	975
14	120	4	2086	2392	2140	2455	3	999
15	128	4	2147	2465	2201	2528	3	1023
16	136	4	2209	2538	2263	2601	3	1047
17	144	5	2417	2785	2485	2864	3	923
18	152	5	2478	2858	2546	2937	3	947
reduction per wall socket			349	378	362	394		

Notes

* rings with plastic inserts

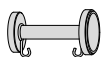

accessories

see page 505

• rods in excess of 9ft. will be delivered in two sections

components see page 503

finishes available

56 black

77 stainless steel

kensington 56 black



lexington 56 black



wimbledon 77 stainless steel



scale 1:1







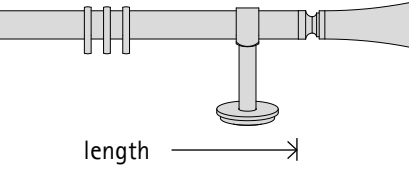

iron 1" dia.

finishes available

- A 56 black
- B 77 stainless steel

single rod







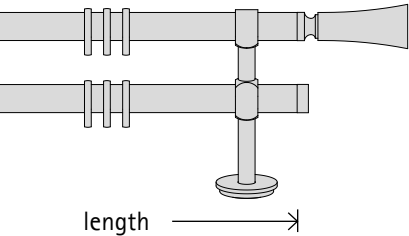

	set-no.
Kensington	
	02601
	02611
Lexington	
	02602
	02612
Wimbledon	
	02603
	02613

length (ft.)	*rings	brackets		brackets 3" or 5"		brackets 7" or 9"		integral	
				A	B	A	B	brackets	surcharge
3	14	2	\$	446	531	473	562	2	306
4	18	2		476	567	503	599	2	318
5	22	2		507	604	534	635	2	330
6	26	3		632	751	672	799	2	248
7	30	3		662	788	703	835	2	260
8	34	3		693	824	733	872	2	272
9	38	3		723	861	764	908	2	284
• 10	42	3		754	897	794	945	3	525
11	48	4		887	1055	941	1118	3	443
12	52	4		918	1091	972	1155	3	455
13	56	4		948	1128	1002	1191	3	467
14	60	4		979	1164	1033	1228	3	479
15	64	4		1009	1201	1063	1264	3	491
16	68	4		1040	1237	1094	1301	3	503
17	72	5		1165	1385	1232	1464	3	421
18	76	5		1195	1422	1263	1501	3	433
reduction per wall socket				122	149	136	165		

double rod



	set-no.
Kensington	
	02606
	
Lexington	
	02607
	
Wimbledon	
	02608
	

length (ft.)	*rings	brackets		brackets 3" or 5"		brackets 7" or 9"		integral	
				A	B	A	B	brackets	surcharge
3	28	2	\$	721	858	748	889	2	612
4	36	2		782	931	809	962	2	636
5	44	2		843	1004	870	1035	2	660
6	52	3		1052	1251	1092	1299	2	537
7	60	3		1113	1324	1153	1372	2	561
8	68	3		1174	1397	1214	1445	2	585
9	76	3		1235	1470	1276	1518	2	609
• 10	84	3		1296	1543	1337	1591	3	1050
11	96	4		1522	1810	1576	1873	3	927
12	104	4		1583	1883	1637	1946	3	951
13	112	4		1644	1956	1698	2019	3	975
14	120	4		1706	2029	1760	2092	3	999
15	128	4		1767	2102	1821	2165	3	1023
16	136	4		1828	2175	1882	2238	3	1047
17	144	5		2037	2423	2104	2502	3	923
18	152	5		2098	2496	2165	2575	3	947
reduction per wall socket				159	197	172	213		

Notes

* rings with plastic inserts

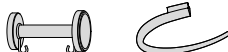







accessories

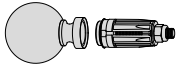

see page 505

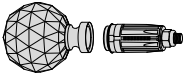
• rods in excess of 9ft. will be delivered in two sections

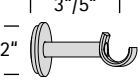
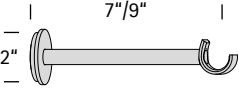
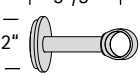
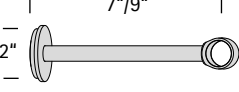
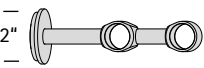
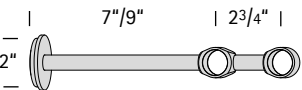
iron 1" dia.

components	part	part-no.	color-no.	price		
	iron tube 1" dia. laquered	25810	56 77	black stainless steel <small>Cut to measure \$/ lin ft.</small>	13.40 16.90	
 3 3/4"	finial Kensington	26871	56 77	black stainless steel	78.80 94.50	
 2 5/8"	Lexington	26872				
 3 3/4"	Wimbledon	26873				
 3"	finial Madison	26874	56/98 77/98	black/crystal glass hand cut stainless steel/crys. glass h. cut	269.10 275.80	
 3/8"	end cap Hampton	26879	56 77	black stainless steel	33.80 40.50	
 3 5/8"	bracket open can be shortened	3"	26836	56 77	black stainless steel	93.90 111.20
		5"	26837			
 7 9/16"	bracket open can be shortened	7"	26838	56 77	black stainless steel	107.40 127.00
		9"	26839			
 3 5/8"	bracket closed can be shortened	3"	26831	56 77	black stainless steel	93.90 111.20
		5"	26832			
 7 9/16"	bracket closed can be shortened	7"	26833	56 77	black stainless steel	107.40 127.00
		9"	26834			
 3 5/8" 2 3/4"	double bracket closed can be shortened	3"	26841	56 77	black stainless steel	147.30 174.50
		5"	26842			
 7 9/16" 2 3/4"	double bracket closed can be shortened	7"	26843	56 77	black stainless steel	160.80 190.30
		9"	26844			

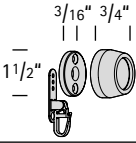
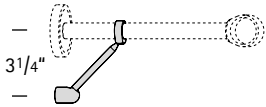
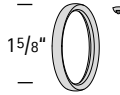
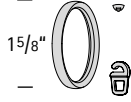
iron 1" dia.

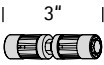
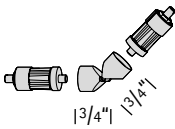
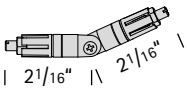
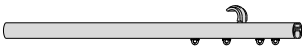
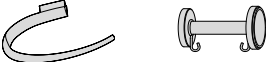
components	part	part-no.	color-no.	price
	extension piece 1"	31619	56 77	black stainless steel 19.00 22.70
	wall socket can be used at both ends	26805	56 77	black stainless steel 50.70 56.30
	bracket support can be retrofitted	20617	56 77	black stainless steel 82.20 100.20
	ring 1 5/8" x 1/4" with plastic insert	26809	56 77	black stainless steel 4.10 4.70
	ring 1 5/8" x 1/4" with plastic insert with eyelet clip	26808	56 77	black stainless steel 4.30 4.90
	eyelet clip	10921	50	white 0.20
	tube connector	25659	99	20.00
	swivel joint	25651	56 77	black stainless steel 130.60 130.60
	mitre connector for any angle mitre cut \$ 43.00	25653	99	94.50
	traversing rod and accessories for extra run			see page 519
	accessories			see page 505

ACCESSORIES



components	part	part-no.	color-no.	price	
	holdback 1" from wall	20886	51	anthracite	104.70
			56	black	104.70
			68	silver	104.70
			74	iron	104.70
			77	stainless steel	117.10
			81	rust	104.70



ACCESSORIES



21892



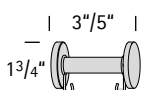
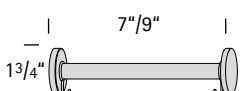

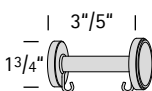
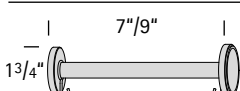
26892

components	part	part-no.	color-no.	price
	tieback	3"	21891 51 anthracite	77.10
			56 black	77.10
		5"	21892 68 silver	77.10
			74 iron	77.10
			77 stainless steel	90.00
81 rust	77.10			
	tieback	7"	21893 51 anthracite	90.60
			56 black	90.60
			68 silver	90.60
		9"	21894 74 iron	90.60
			77 stainless steel	105.80
			81 rust	90.60
	rosette	82291	51 anthracite	31.50
			56 black	31.50
			68 silver	31.50
			74 iron	31.50
			77 stainless steel	36.00
			81 rust	31.50
	tieback	3"	26891 51 anthracite	88.40
			56 black	88.40
			68 silver	88.40
		5"	26892 74 iron	88.40
			77 stainless steel	103.50
			81 rust	88.40
				tieback
56 black	101.90			
68 silver	101.90			
9"	26894 74 iron	101.90		
	77 stainless steel	119.30		
81 rust	101.90			

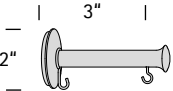

16891

components	part	part-no.	color-no.	price
	rosette	82691	51 anthracite 56 black 68 silver 74 iron 77 stainless steel 81 rust	42.80 42.80 42.80 42.80 49.50 42.80
	tieback 3" for iron 5/8" dia.	16891	51 anthracite 81 rust	57.40 57.40
	tieback 5" for iron 5/8" dia.	16892	51 anthracite 81 rust	66.40 66.40



wood

1³/₁₆"
dia.



delft walnut



davos white



delhi genuine beech



tieback
genuine beech p. 518

Staked Lime-Dark 151

Staked Lime-Deep



21 walnut 23 light oak 25 cherry 40 genuine beech 50 white



delft 25 cherry

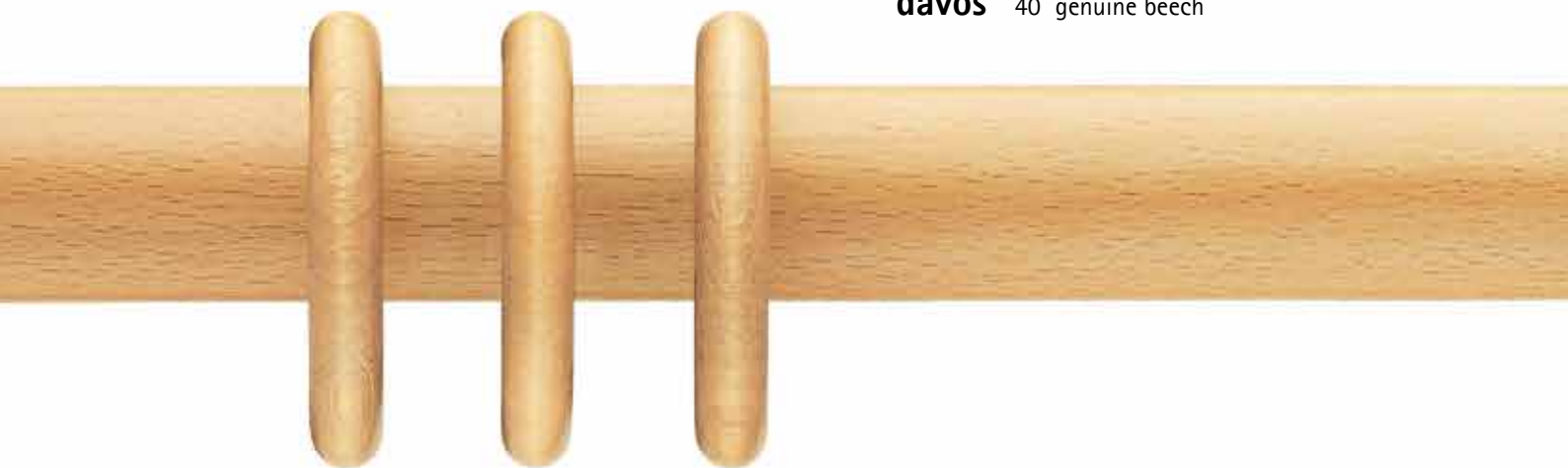

davos 40 genuine beech

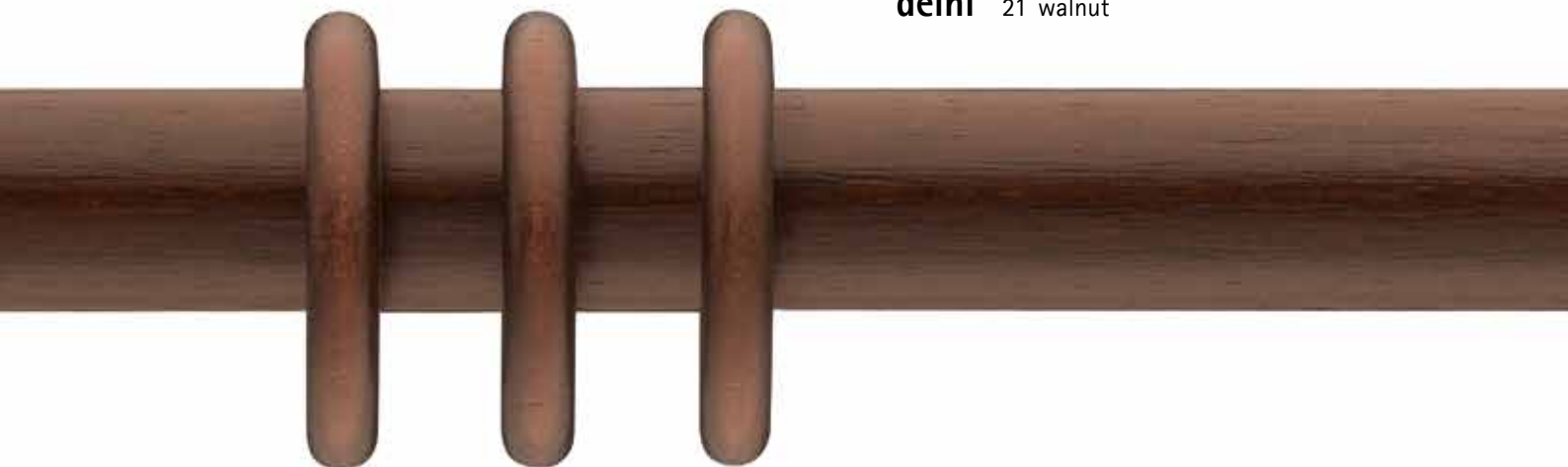

delhi 21 walnut

scale 1:1



wood 1 3/16" dia.

finishes available

- | | |
|--------------------|---------------------------|
| A 21 walnut | B 50 white |
| 23 light oak | C 40 genuine beech |
| 25 cherry | |

single rod

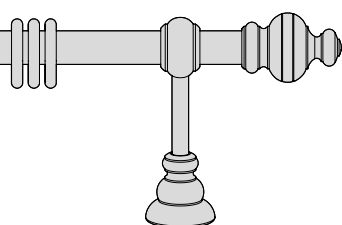

length →

- | | | |
|--|--------------|-------|
| | Delft | 03001 |
| | Davos | 03003 |
| | Delhi | 03005 |

length (ft.)	rings	brackets		bracket 6 3/4"			bracket 9"			bracket 11"		
				A	B	C	A	B	C	A	B	C
3	14	2	\$	132	151	143	148	170	160	170	195	181
4	18	2		150	171	165	166	191	182	188	216	203
5	22	2		168	192	187	184	212	204	206	236	225
6	26	2		186	213	209	202	232	226	224	257	247
7	30	3		226	259	253	251	288	278	283	325	311
8	34	3		244	280	275	269	309	300	301	346	333
9	38	3		262	300	297	287	329	322	320	367	355
• 10	42	3		280	321	319	305	350	344	338	387	377
11	48	3		302	346	345	327	375	370	359	412	402
12	52	3		320	366	367	345	396	392	377	433	424
13	56	4		360	413	411	393	451	444	437	501	487
14	60	4		378	433	433	411	472	466	455	522	509
15	64	4		397	454	455	429	493	488	473	542	531
16	68	4		415	475	477	447	513	510	491	563	553
17	72	4		433	495	499	466	534	532	509	584	575
18	76	4		451	516	521	484	555	554	527	604	597
			reduction per wall socket	21	24	21	29	34	29	40	46	40

double rod

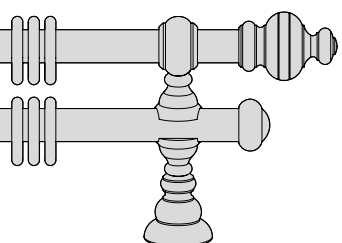

length →

- | | | |
|--|--------------|-------|
| | Delft | 03013 |
| | Davos | 03015 |
| | Delhi | 03017 |

length (ft.)	rings	brackets		bracket 4 1/4"			bracket 6 3/4"			bracket 8 3/4"		
				A	B	C	A	B	C	A	B	C
3	28	2	\$	253	290	277	290	333	313	312	358	335
4	36	2		289	332	321	326	374	357	348	399	379
5	44	2		326	373	365	362	416	401	384	441	423
6	52	2		362	414	409	399	457	445	420	482	467
7	60	3		439	502	493	494	567	548	526	604	581
8	68	3		475	544	537	530	608	592	563	645	625
9	76	3		511	585	581	566	649	636	599	687	669
• 10	84	3		547	627	625	602	691	680	635	728	713
11	96	3		591	676	676	646	740	732	678	777	764
12	104	3		627	717	720	682	782	776	715	819	808
13	112	4		703	805	805	777	891	878	821	941	922
14	120	4		740	847	849	813	932	922	857	982	966
15	128	4		776	888	893	849	974	966	893	1023	1010
16	136	4		812	930	937	886	1015	1010	929	1065	1054
17	144	4		848	971	981	922	1057	1054	965	1106	1098
18	152	4		884	1012	1025	958	1098	1098	1002	1148	1142
			reduction per wall socket	37	43	37	56	64	56	66	76	66

Notes

- rods in excess of 9ft. will be delivered in two sections



tieback

see page 518

wood 1 3/16" dia.

finishes available

- | | | | |
|----------|--------------|----------|------------------|
| A | 21 walnut | B | 50 white |
| | 23 light oak | C | 40 genuine beech |
| | 25 cherry | | |

double rod with traversing rod

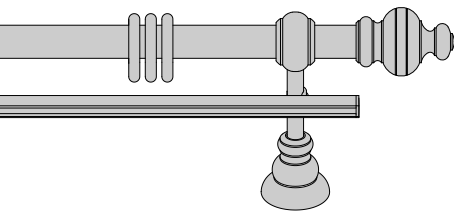

length →

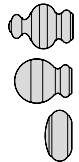

	set-no.
Delft	03007
Davos	03009
Delhi	03011

length (ft.)	rings	glider	brackets	\$	bracket 6 3/4"			bracket 9"			bracket 11"		
					A	B	C	A	B	C	A	B	C
3	14	16	2		215	234	227	232	254	243	253	279	265
4	18	20	2		251	273	267	268	292	283	289	317	305
5	22	24	3		315	343	335	340	372	359	372	409	392
6	26	30	3		353	383	376	377	412	401	410	449	434
7	30	34	3		389	422	416	414	451	441	446	488	474
8	34	40	3		427	462	458	451	491	482	484	528	515
9	38	44	4		491	532	526	523	571	558	567	620	602
• 10	42	50	4		528	572	567	561	611	600	605	661	644
11	48	54	4		568	615	611	601	654	644	644	703	687
12	52	60	4		606	655	652	638	694	685	682	744	729
13	56	64	4		642	694	692	675	733	725	718	782	769
14	60	68	5		706	764	760	747	812	801	801	874	856
15	64	74	5		743	804	802	784	853	843	839	915	897
16	68	78	5		779	843	842	820	891	883	875	953	937
17	72	84	5		817	883	883	858	932	924	913	994	979
18	76	90	5		855	923	925	896	972	966	950	1034	1021
surcharge/reduction per wall socket					+17	+14	+17	+9	+4	+9	2	8	2

Notes

- rods in excess of 9ft. will be delivered in two sections

colour coordination with traversing rod see page 518

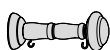



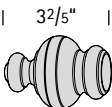
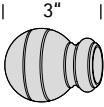
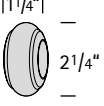
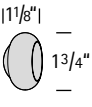
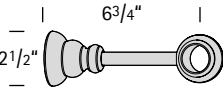
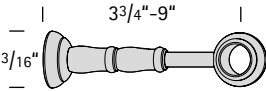
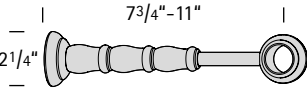
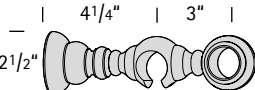

tieback see page 518

components see page 516

wood 1 3/16" dia.

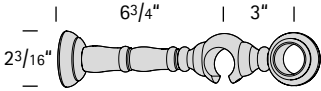
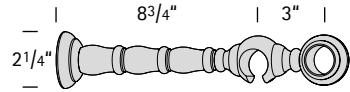
components	part	part-no.	color-no.	price
	wooden pole 1 3/16" dia.	30010	01 unfinished 21 walnut 23 light oak 25 cherry 40 genuine beech 50 white	Cut do measure \$/ lin ft. 10.90 10.90 10.90 10.90 14.80 12.70
	finial Delft	30001	01 unfinished 21 walnut 23 light oak 25 cherry 40 genuine beech 50 white	14.70 14.70 14.70 14.70 14.70 16.90
	Davos	30002		
	Delhi	30003		
	end cap	30029	01 unfinished 21 walnut 23 light oak 25 cherry 40 genuine beech 50 white	13.50 13.50 13.50 13.50 13.50 15.50
	bracket 6 3/4" can be shortened	30012	01 unfinished 21 walnut 23 light oak 25 cherry 40 genuine beech 50 white	22.10 22.10 22.10 22.10 22.10 25.40
	bracket 9" extendable	30013	01 unfinished 21 walnut 23 light oak 25 cherry 40 genuine beech 50 white	30.30 30.30 30.30 30.30 30.30 35.10
	bracket 11" extendable	30014	01 unfinished 21 walnut 23 light oak 25 cherry 40 genuine beech 50 white	41.20 41.20 41.20 41.20 41.20 47.50
	double bracket 4 1/4"	30022	01 unfinished 21 walnut 23 light oak 25 cherry 40 genuine beech 50 white	40.50 40.50 40.50 40.50 40.50 46.60

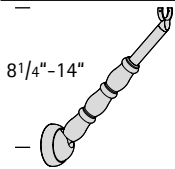
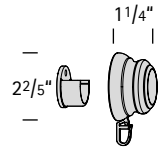
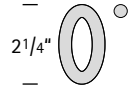
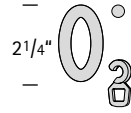
wood 1³/₁₆" dia.

components	part	part-no.	color-no.	price
	double bracket 6 ³ / ₄ "	30023	01 unfinished	58.90
			21 walnut	58.90
			23 light oak	58.90
			25 cherry	58.90
			40 genuine beech	58.90
			50 white	68.00
	double bracket 8 ³ / ₄ "	30024	01 unfinished	69.80
			21 walnut	69.80
			23 light oak	69.80
			25 cherry	69.80
			40 genuine beech	69.80
			50 white	80.40
	extension piece 2"	28019	01 unfinished	10.20
			21 walnut	10.20
			23 light oak	10.20
			25 cherry	10.20
			40 genuine beech	10.20
			50 white	11.30
	bracket support can be shortened	28017	01 unfinished	42.80
			21 walnut	42.80
			23 light oak	42.80
			25 cherry	42.80
			40 genuine beech	42.80
			50 white	49.30
	wall socket with anchor clip can be used at both ends	30005	01 unfinished	15.80
			21 walnut	15.80
			23 light oak	15.80
			25 cherry	15.80
			40 genuine beech	15.80
			50 white	18.20
	ring 2¹/₄" x 3/16"	30009	01 unfinished	1.60
			21 walnut	1.60
			23 light oak	1.60
			25 cherry	1.60
			40 genuine beech	1.60
			50 white	1.80
	ring 2¹/₄" x 3/16" with eyelet clip	30008	01 unfinished	1.80
			21 walnut	1.80
			23 light oak	1.80
			25 cherry	1.80
			40 genuine beech	1.80
			50 white	2.00
	eyelet clip	10930	50 white	0.20

wood 1³/₁₆" dia.

components



part	part-no.	color-no.	price
elbow 90° any angle cut to measure from 90° to 160° surcharge \$ 56.00	30050	01 unfinished	38.30
		21 walnut	38.30
		23 light oak	38.30
		25 cherry	38.30
		40 genuine beech	38.30
		50 white	44.10

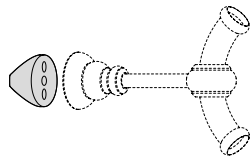

socket for corner mount with elbow 90° corners only	28060	50 white	32.70
--	-------	----------	-------



pole connector	30059	99	5.90
-----------------------	-------	----	------

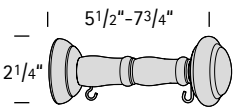

tieback extendable can be shortened	30091	01 unfinished	29.30
		21 walnut	29.30
		23 light oak	29.30
		25 cherry	29.30
		40 genuine beech	29.30
		50 white	33.80

color coordination with traversing rod

finish set			color traversing rod		finish set			color traversing rod	
wood	21	walnut	80	antique bronzed	iron	51	anthracite	56	black
	23	light oak	62	brushed brass		56	black	56	black
	25	cherry	62	brushed brass		68	silver	79	aluminium
	40	genuine beech	62	brushed brass		74	iron	72	brushed nickel
	50	white	50	white		77	stainless steel	77	stainless steel
					81	rust	80	antique bronzed	

accessories

finishes available

- A** 50 white
 56 black
 62 brushed brass
 72 brushed nickel
 79 aluminium
 80 antique bronzed

material: aluminium



- B** 77 stainless steel

traversing rod



length (ft.)	rollers	holder	material: aluminium	
			A	B
3	16	2	\$ 84	95
4	20	2	102	116
5	24	3	125	144
6	30	3	145	167
7	34	3	163	189
8	40	3	183	212
9	44	4	206	240
• 10	50	4	226	263
11	54	4	244	285
12	60	4	263	308
13	64	4	281	330
14	68	5	305	357
15	74	5	325	380
16	78	5	343	402
17	84	5	362	425
18	88	5	380	447
surcharge per wall socket			+38	+52

- rods in excess of 9ft. will be delivered in two sections

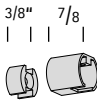
components traversing rod

	part	part-no.	color.-no.	price
	traversing rod 3/4" dia. material: aluminium	30570	50 white	Cut to measure \$ / lin. ft. 14.80
			56 black	
			62 brushed brass	
			72 brushed nickel	
			77 stainless steel	
			79 aluminium	
			80 antique bronzed	
			14.80	
	holder for traversing rod	30572	50 white	5.70
			56 black	5.70
			60 polished brass (for color 62)	5.70
			71 polished nickel (for color 72, 77.79)	5.70
			77 stainless steel	5.70
			80 antique bronzed	5.70
	end cap	21829	50 white	5.70
			56 black	5.70
			60 polished brass (for color 62)	5.70
			71 polished nickel (for color 72)	5.70
			77 stainless steel	5.70
			79 aluminium	5.70
			80 antique bronzed	5.70
			5.70	
	wall socket can be used at both ends	21705	50 white	49.50
			56 black	49.50
			62 brushed brass	49.50
			72 brushed nickel	49.50
			77 stainless steel	63.00
			79 aluminium	49.50
			80 antique bronzed	49.50
			49.50	

accessories

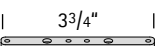
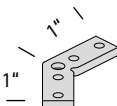
components	part	part-no.	color-no.	price
 $\frac{1}{2}$ "	roller with eyelet	30082	50 white	0.80
 $\frac{5}{8}$ "	curtain hook	30080	50 white	0.20
	runner for batons can be retrofitted	30078	50 white	3.60
	stop clamp	30089	50 white	1.80
 $\frac{3}{4}$ "	connector	30579	99	16.90
 $\frac{13}{16}$ "	corner connector 90°	30550	99	25.90
 1"	corner connector 135°	30551	99	30.40
 $\frac{13}{4}$ "	corner connector flexible	30552	99	59.70