



ARENA PLUS KITCHEN ACCESSORIES





PULL-OUT PANTRY SYSTEMS

WALL UNIT AND PANTRY CABINETS STORAGE SYSTEMS



DISPENSA U.S.

- Total pull-out sliding shelf system for face frame and frameless applications.
- For a complete set, order one frame plus one or more sets of Arena shelves.
- Each shelf has an anti-slip melamine surface for enhanced stability and noise reduction.
- To be installed on the upper and lower interior surface of your pantry.
- Equipped with a shock-absorbing mechanism for a soft opening & closing.
- Complete access to the cabinet content in one movement.
- Weight capacity: max. 265 lb (120 kg).
- Height-adjustable frames for interior heights of 31 1/2" to 90 1/2" (800 to 2300 mm).
- Frame finish: silver gray or champagne.
- Arena shelves finishes: gray/chrome, maple/chrome, maple/champagne, anthracite/chrome and white/chrome.
- Shelves are offered in set of 2.
- 9 different shelf widths from 8" to 19" (203 to 559 mm).



Gray/chrome



Maple/chrome



Maple/champagne



White/chrome



Anthracite/chrome
(flat rail style)

PULL-OUT PANTRY SYSTEMS



FRAMED CABINET

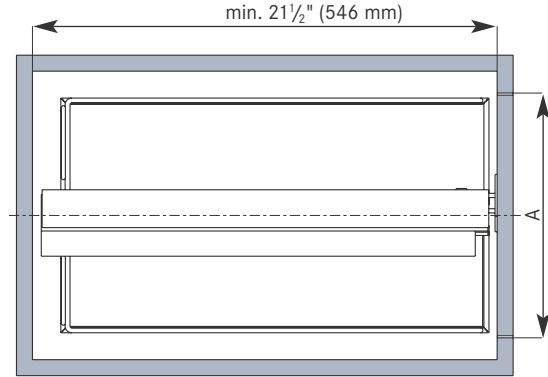

FRAMELESS CABINET

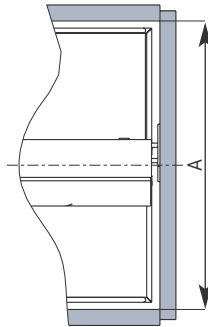

Frame set

includes frame, runner, door brackets and integrated soft close:

FRAME DIMENSIONS (WxDxH*)	SILVER GRAY	CHAMPAGNE	NUMBER OF SHELF SETS
4 3/4" x 21 3/8" x 31 1/2" - 47 1/4" (121 x 543 x 800 - 1200 mm)	24160100	24160155	1-2 sets of two shelves
4 3/4" x 21 3/8" x 47 1/4" - 62 7/8" (121 x 543 x 1200 - 1600 mm)	24260100	24260155	2-3 sets of two shelves
4 3/4" x 21 3/8" x 62 7/8" - 78 3/4" (121 x 543 x 1600 - 2000 mm)	24382100	24382155	3-4 sets of two shelves
4 3/4" x 21 3/8" x 74 3/4" - 90 1/2" (121 x 543 x 1900 - 2300 mm)	24383100	24383155	3-4 sets of two shelves

*H = Cabinet interior height

Arena shelves (set of 2 shelves)

D: 20 3/8" (518 mm) - H: 4 1/8" (105 mm)

MIN. OPENING WIDTH (A)	SHELF DIMENSIONS (WxDxH)	GRAY/CHROME	MAPLE/CHROME	MAPLE/CHAMPAGNE	WHITE/CHROME	ANT/CHROME
8 1/2" (216 mm)	8" x 20 3/8" x 4 1/8" (203 x 518 x 105 mm)	25140100	25140150	25155150	2514030	25140906
10 1/2" (267 mm)	10" x 20 3/8" x 4 1/8" (254 x 518 x 105 mm)	35140100	35140150	35155150	3514030	35140906
11 1/2" (292 mm)	11" x 20 3/8" x 4 1/8" (279 x 518 x 105 mm)	26140100	26140150	26155150	2614030	26140906
13 1/2" (343 mm)	13" x 20 3/8" x 4 1/8" (330 x 518 x 105 mm)	36140100	36140150	36155150	3614030	36140906
14 1/2" (368 mm)	14" x 20 3/8" x 4 1/8" (356 x 518 x 105 mm)	27140100	27140150	27155150	2714030	27140906
16 1/2" (419 mm)	16" x 20 3/8" x 4 1/8" (406 x 518 x 105 mm)	37140100	37140150	37155150	3714030	37140906
17 1/2" (445 mm)	17" x 20 3/8" x 4 1/8" (432 x 518 x 105 mm)	28140100	28140150	28155150	2814030	-
19 1/2" (495 mm)	19" x 20 3/8" x 4 1/8" (483 x 518 x 105 mm)	38140100	38140150	38155150	3814030	-
20 1/2" (520 mm)	20" x 20 3/8" x 4 1/8" (508 x 518 x 105 mm)	39140100	39140150	39155150	3914030	-

NOTES:

- DOOR MOUNTED • WORKS WITH OVERLAY AND INSET DOORS

Accessories

DESCRIPTION	SILVER GRAY	CHAMPAGNE	SOLD BY
Extra shelf holder - use to add more shelves when frame extended more than 8" (203 mm)	4276100	4276155	Pair
Door stabilizer - for more stability between frame and door	4350100	4350155	Piece



No. 4276XXX
Extra shelf holder



No. 4350XXX
Door stabilizer



PULL-OUT PANTRY SYSTEMS

WALL UNIT AND PANTRY CABINETS STORAGE SYSTEMS



CONVOY LAVIDO

The ultimate storage solution for pantry units

- Hinged door application.
- Unit comes with one frame, one runner and 4 or 5 shelves to order separately, depending on the internal height.
- 5 frame heights, 3 widths, 2 colors (gray/chrome, maple/chrome).
- Unique synchronized runner (soft closing and assisted opening requiring less pull-out force).
- Easy and unlimited shelf height adjustments.
- Shelves come with anti-slip melamine surface and chrome surround.
- Shelves are accessible from 3 sides.
- Recommended to use no protrusion hinges.
- Weight capacity: 286 lb (130 kg).



Storage space optimisation



Glass rails for optimal visibility of contents



Easy and unlimited shelf height adjustments



Access on the 3 sides of the shelves

PULL-OUT PANTRY SYSTEMS



FOR A COMPLETE SET, ORDER: 1 runner + 1 frame + 1 set of 4 shelves + x number of extra shelves, as needed
Internal depth required: 19 3/4" (500 mm)

NO.	DESCRIPTION	FINISH
23730100	Lavido runner	Gray



No. 23730100
Runner

Frame

NO.	DESCRIPTION	PRODUCT HEIGHT	SUGGESTED INTERIOR CABINET HEIGHT*	FINISH	NUMBER OF SHELVES
23650100	Frame Lavido 1130	51 1/4" (1302 mm)	Min. 63 1/2" (1606 mm)*	Gray	Min. 4
23660100	Frame Lavido 1230	55 1/8" (1400 mm)	Min. 67 1/16" (1704 mm) *	Gray	Min. 4
23670100	Frame Lavido 1330	59 1/8" (1502 mm)	Min. 71 1/8" (1806 mm) *	Gray	Min. 5
23690100	Frame Lavido 1530	67" (1702 mm)	Min. 79" (2006 mm) *	Gray	Min. 5

*Suggested interior height includes 12" (304 mm) of empty space to allow storage of goods on top shelf.

Shelves

DESCRIPTION	SHELF WIDTH	OPENING WIDTH	GRAY/CHROME	MAPLE/CHROME	NUMBER OF SHELVES
Set of 4 shelves 450	15 3/4" (400 mm)	16 1/2" (412 mm)	2531140100	2531140150	4
Set of 4 shelves 500	17 3/4" (450 mm)	18 1/8" (462 mm)	2533140100	2533140150	4
Set of 4 shelves 600	21 5/8" (550 mm)	22 1/8" (562 mm)	2534140100	2534140150	4
Single shelf 450	15 3/4" (400 mm)	16 1/2" (412 mm)	1531140100	1531140150	1
Single shelf 500	17 3/4" (450 mm)	18 1/8" (462 mm)	1533140100	1533140150	1
Single shelf 600	21 5/8" (550 mm)	22 1/8" (562 mm)	1534140100	1534140150	1

If you need more than 4 shelves,
order one set of 4 + additional single shelves as required.



Gray/chrome



Maple/chrome



Frame



PULL-OUT RECYCLING CENTERS



SINGLE BIN ILLUSTRATED

K WASTEBIN PULLOUT

Bottom and door-mounted wastebin system with large capacity in a narrow space!

- The frames can be equipped with a "Push to Open" device (No. **61015100** or No. **61015155**, sold separately) that opens the system with a soft push on the door.
- Available in single or double bin configuration.
- Door mounting brackets with 3 ways adjustments.
- Suitable for cabinets with overlays or inset doors.
- Full-extension undermount slides equipped with a soft-closing mechanism.
- Bin capacity: 36 or 52 qt. (34 or 49 l).
- Frame colors available: gray, chrome, champagne.
- Bin colors: white, gray, champagne.
- Single bin version offers extra storage space at the back, ideal to store cleaning material.
- Weight capacity: 100 lb (45 kg).
- Frame and bins have to be ordered separately, allows you to create multiple configurations.
- Installation template included.



Installation dimensions for a complete unit:

TYPE	MIN. OPENING WIDTH		MIN. INT. WIDTH	MIN. INT. DEPTH	MIN. OPENING HEIGHT (for single & double bin frame)
	FACE FRAME	FRAMELESS	FACE FRAME / FRAMELESS		
Single bin	11 1/2" (292 mm)	12 1/2" (318 mm)	12 1/2" (318 mm)	22 1/2" (572 mm)	19 1/2" (495 mm) for 36 qt. bin
Double bin	14 1/2" (368 mm)	15 1/2" (394 mm)	15 1/2" (394mm)	22 1/2" (572 mm)	23 1/2" (597 mm) for 52 qt. bin



Frame

NO.	DESCRIPTION	FINISH
61010100	Single bin frame	Silver gray
61010140	Single bin frame	Chrome
61010155	Single bin frame	Champagne
61020100	Double bin frame	Silver gray
61020140	Double bin frame	Chrome
61020155	Double bin frame	Champagne

Optional "Push to Open" device

Easy to install mechanical system – no need for electricity



No. 61015100
PTO mechanism
Silver gray

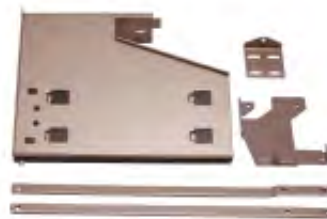

No. 61015155
PTO mechanism
Champagne

Bins

NO.	CAPACITY	FINISH	NO.	CAPACITY	FINISH
5101230	36 qt.	White	5105230	52 qt.	White
51012100	36 qt.	Gray	51052100	52 qt.	Gray
51012155	36 qt.	Champagne	51052155	52 qt.	Champagne

Single bin frame,
order 1 bin
Double bin frame,
order 2 bins



No. 51152030
White lid



No. 51152100
Gray lid



No. 51152155
Champagne lid

Wide door bracket

NO.	FINISH
25079100	Silver gray
25079155	Champagne

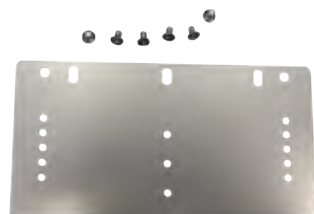

25079100



25079155

- Optional wide door bracket
- Allows to reach the frame on a shaker door type
- Order 2 brackets for a complete set



SLIDING STORAGE SYSTEMS

BASE CABINETS



BASE PULL-OUT II

- Height-adjustable center-mounted frame for a perfect fit every time.
- Full-extension slides for excellent view and optimal access to stored items.
- Equipped with a soft-closing mechanism.
- Top and bottom mounted: easy installation.
- Hooks on the frame allow shelves to be adjusted in height.
- Door-mounted application for a complete access in one motion.
- 3-way door adjustment (door brackets included).
- Frame finish: silver gray or champagne.
- Arena shelves with anti-slip melamine surface: gray/chrome, maple/chrome or maple/champagne finish.
- Weight capacity: 60 lb (27.5 kg).
- Thinner top rail for easier access to the contents.
- Two frame options: for full height cabinets or under drawer application.
- Shelves offered in sets of 2.

Interior depth required: min. 22 1/2" (571 mm)

FRAMED CABINET

FRAMELESS CABINET

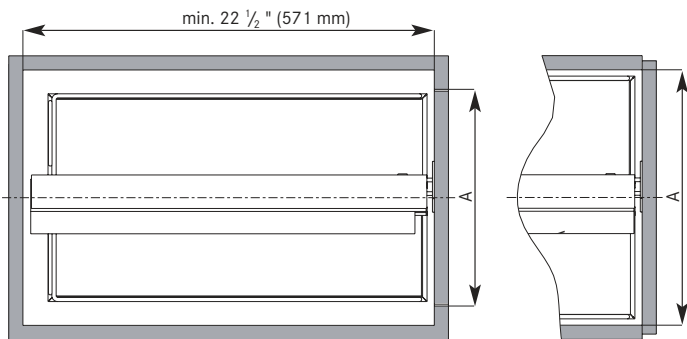

Frame set includes frame, runner, door brackets and integrated soft close:

FRAME TYPE	FRAME DIMENSIONS (WxDxH*)	SILVER GRAY	CHAMPAGNE
Short	3 3/4" x 22" x 20" - 28" (95 x 559 x 508 - 711 mm)	2662100	2662155
Tall	3 3/4" x 22" x 24" - 32" (95 x 559 x 610 - 813 mm)	2663100	2663155

*H = Cabinet interior height

DESCRIPTION	DIMENSIONS	SILVER GRAY	CHAMPAGNE
Extra shelf holder*	Height 4" (102 mm)	4255100	4255155
Wide door bracket	5 1/2" (140 mm) L x 1 1/2" (38 mm) H	2647100	2647155

Additional lateral bar

DIMENSIONS (Inside Cabinet width)	ZINC
4 1/2" to 5" (114 to 127 mm)	2760452G
7 1/2" to 10 1/2" (191 to 267 mm)	2760752G
13 1/2" to 19 1/2" (343 to 495 mm)	2761352G

Extra shelf holder



* Can only be used when frame height is extended by more than 4" (102 mm)



The wide front fixing bracket is required for all cabinets that are wider than 15" (381 mm). Optional for less than 15" (381 mm). This will replace the original lower bracket only.



2760452G



2760752G



2761352G

These optional lateral bar supports are used when the top center roller guide can't be mounted directly to the cabinet, most commonly used for under drawer application.



Gray/chrome



Maple/chrome



Maple/champagne



White/chrome



Anthracite/chrome
(flat rail style)

Arena shelves (set of 2 shelves)

MIN. OPENING WIDTH (A)	SHELF DIMENSIONS (WxDxH)	GRAY/CHROME	MAPLE/CHROME	MAPLE/CHAMPAGNE	WHITE/CHROME	ANT/CHROME
4 1/2" (114 mm)	4" x 20 3/8" x 4 1/8" (102 x 518 x 105 mm)	33140100	33140150	33155150	3314030	33140906
5 1/2" (140 mm)	5" x 20 3/8" x 4 1/8" (127 x 518 x 105 mm)	24140100	24140150	24155150	2414030	24140906
7 1/2" (191 mm)	7" x 20 3/8" x 4 1/8" (178 x 518 x 105 mm)	34140100	34140150	34155150	3414030	34140906
8 1/2" (216 mm)	8" x 20 3/8" x 4 1/8" (203 x 518 x 105 mm)	25140100	25140150	25155150	2514030	25140906
10 1/2" (267 mm)	10" x 20 3/8" x 4 1/8" (254 x 518 x 105 mm)	35140100	35140150	35155150	3514030	35140906
11 1/2" (292 mm)	11" x 20 3/8" x 4 1/8" (279 x 518 x 105 mm)	26140100	26140150	26155150	2614030	26140906
13 1/2" (343 mm)	13" x 20 3/8" x 4 1/8" (330 x 518 x 105 mm)	36140100	36140150	36155150	3614030	36140906
14 1/2" (368 mm)	14" x 20 3/8" x 4 1/8" (356 x 518 x 105 mm)	27140100	27140150	27155150	2714030	27140906
16 1/2" (419 mm)	16" x 20 3/8" x 4 1/8" (406 x 518 x 105 mm)	37140100	37140150	37155150	3714030	37140906
17 1/2" (445 mm)	17" x 20 3/8" x 4 1/8" (432 x 518 x 105 mm)	28140100	28140150	28155150	2814030	-
19 1/2" (495 mm)	19" x 20 3/8" x 4 1/8" (483 x 518 x 105 mm)	38140100	38140150	38155150	3814030	-
20 1/2" (521 mm)	20" x 20 3/8" x 4 1/8" (508 x 518 x 105 mm)	39140100	39140150	39155150	3914030	-

NOTE: • DOOR MOUNTED

Metal shelves (set of 2 shelves)

MIN. OPENING WIDTH	DIMENSIONS (WxDxH)	SILVER GRAY	CHAMPAGNE
3 3/4" (95 mm)	3 5/16" x 20 3/8" x 2" (84 mm x 518 mm x 50 mm)	25474100	25474155
4 1/2" (114 mm)	4" x 20 3/8" x 2" (102 mm x 518 mm x 50 mm)	25475100	25475155
5 1/2" (140 mm)	5" x 20 3/8" x 2" (127 mm x 518 mm x 50 mm)	25476100	25476155
7 1/2" (191 mm)	7" x 20 3/8" x 2" (178 mm x 518 mm x 50 mm)	25477100	25477155



Metal shelf

Accessories

MIN. OPENING WIDTH	DESCRIPTION	DIMENSIONS (WxDxH)	SILVER GRAY	CHAMPAGNE
10 1/2" (267 mm)*	Youbox set 1	4 1/2" x 17 1/4" X 3 3/4" (114 mm x 438 mm x 95 mm)	25464100	25464155
10 1/2" (267 mm)*	Youbox set 2	4 1/2" x 17 1/4" X 3 3/4" (114 mm x 438 mm x 95 mm)	25465100	25465155
3 7/8" (98 mm)	Tray support kit 3 5/16"	3 3/8" x 20 3/8" x min. 8" (86 mm x 518 mm x min. 203 mm)	25556100	25556155
5 1/2" (140 mm)	Tray support kit 5"	5" x 20 3/8" x min. 8" (127 mm x 518 mm x min. 203 mm)	25557100	25557155
7 1/2" (191 mm)	Tray support kit 7"	7" x 20 3/8" x min. 8" (178 mm x 518 mm x min. 203 mm)	25558100	25558155
10 1/2" (267 mm)*	Spice tray BPO II 4 3/8"	4 1/2" x 20 1/2" x 1 1/2" (114 mm x 521 mm x 38 mm)	25771100	25771155



Spice tray (sold per unit)

* The min. opening is for 2 spice trays, one on each side of the frame. (Recommended)



Youbox set 1



Youbox set 2

* Based on installing 1 set of rails on each side of the frame (Recommended)



Tray support kit

Each tray support kit includes the bottom metal shelf.



SLIDING STORAGE SYSTEMS

BASE CABINETS



Left access

COMFORT II SIDE-MOUNTED PULL-OUT

- The frame is attached to the door, allowing direct access to the contents.
- Offered in various heights and widths.
- Side mounted (use spacer for face frame application).
- Right- or left-mounted frame available.
- Quick assembly front fixing brackets with 3-way adjustment included.
- Gray metal frame, Arena anti-slip melamine shelves offered in gray/chrome or maple/chrome.
- Full-extension slides with integrated soft-closing mechanism.
- Weight capacity: 52 lb (24 kg).
- Bottle storage available.
- Ideal for frameless cabinets, use spacers for face frame cabinets.



No. 5144140
Wine bottle rack

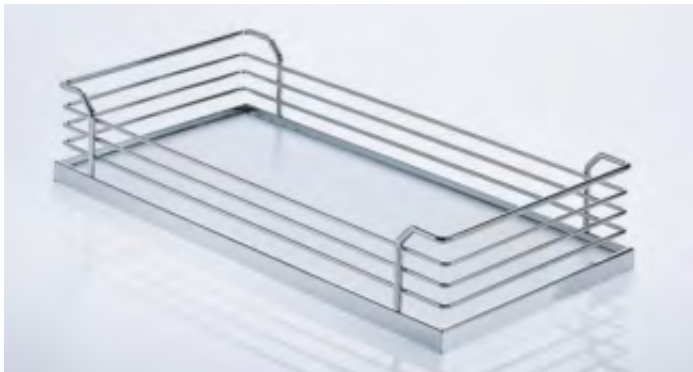

Gray/chrome

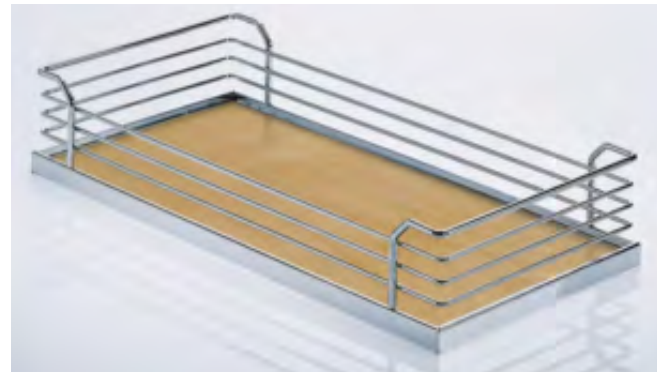

Maple/chrome

SLIDING STORAGE SYSTEMS



FOR A COMPLETE SET, ORDER:

- 1 frame according to the available interior height
 - suggested number of shelves
 - options like spacers if required

INTERNAL CABINET DEPTH REQUIRED
min. 19 1/8" (485 mm)

INTERIOR HEIGHT REQUIRED	LEFT ACCESS*	RIGHT ACCESS*	NUMBER OF SHELVES
Min. 20 3/4" (526 mm)	607520100	607530100	2
Min. 25 3/4" (654 mm)	607560100	607570100	2-3

*For left access, the frame is installed on the right side and vice-versa



No. 60285012
1" spacer

No. 455670100
1" spacer

No. 458240100
1/2" clip-on spacer



Shelves

INTERIOR WIDTH REQUIRED (including frame thickness)	GRAY/CHROME	MAPLE/CHROME	WINE BOTTLE RACK
Min. 5 3/4" (145 mm)	5140140100	5140140150	-
Min. 7 3/4" (195 mm)	5141140100	5141140150	-
Min. 10 1/2" (265 mm)	5142140100	5142140150	-
Min. 11 7/8" (300 mm)	-	-	5144140
Min. 14" (355 mm)	5143140100	5143140150	-



No. 252770100 – Spice Tray Comfort II gray



SLIDING STORAGE SYSTEMS

BASE CABINETS



COOKO FOR STORING INGREDIENTS AND COOKING UTENSILS

- Modular design that makes it so versatile and flexible. You can really customize your storage organization as needed!
- Bottom mount full-extension pull-out that gives you access to everything at your fingertips.
- Mounts to the door for an easy one-motion access.
- Equipped with a soft-closing mechanism.



NO.	DESCRIPTION	REQUIRED INTERIOR DIMENSIONS (W x D x H)	WEIGHT CAPACITY	FINISH
25235140100	For pull-out door	10 1/4" x 19 1/4" x 24 5/8" (260 x 489 x 625 mm)	36 lb (16 kg)	Gray/chrome



TOWEL RACK - No. 115399140

SLIDING BASKETS FOR NARROW CABINETS

Interior width required: 4 7/16" (112 mm)

- Ideal for frameless cabinets.
- Mounts to the interior right side of the cabinet and door.
- Should be installed prior to the final assembly of the cabinet.
- Equipped with a soft-closing mechanism.
- Anti-slip mats in dark gray can be added onto the shelves (No. 480483100).
- Additional dividers available (No. 5293140).
- Weight capacity: max. 26 lb (12 kg).



No. 15297140
2 shelves



No. 115399140
Towel rack



No. 115400140
Cookware storage



No. 15298140
3 shelves



No. 5293140
Tray divider



No. 480483100
Anti-slip mat

NO.	DESCRIPTION	FINISH	INTERIOR DIMENSIONS (WxDxH)
115399140	Towel rack pull-out	Chrome	4 7/16" x 19" x 23 1/4" (112 x 481 x 590 mm)
115400140	Cookware storage pull-out	Chrome	4 7/16" x 19" x 23 1/4" (112 x 481 x 590 mm)
15297140	2-shelf pull-out	Chrome	4 7/16" x 19" x 21 1/4" (112 x 481 x 540 mm)
15298140	3-shelf pull-out	Chrome	4 7/16" x 19" x 29 3/4" (112 x 481 x 755 mm)
15297100	2-shelf pull-out	Silver gray	4 7/16" x 19" x 21 1/4" (112 x 481 x 540 mm)



SLIDING BASKETS

UNDERSINK CABINETS



PORTERO UNDERSINK SOLUTIONS

- All cleaning products in one roll out for your undersink cabinet.
- Bottom mounted: easy installation.
- 3 models available.
- Equipped with a soft-closing mechanism.
- Plastic trays are dishwasher safe.
- Some baskets are portable and can be used throughout the house.
- Weight capacity: 38 lb (17 kg).

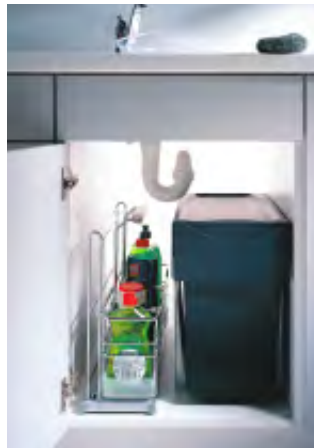

No. 5151140
Portero, 1 basket



No. 51502140
Portero, 2 baskets



No. 5153140
Portero, 3 baskets

NO.	DESCRIPTION	FINISH	PRODUCT DIMENSIONS (WxDxH)*
5151140	Portero, 1 basket	Gray/chrome	6 5/16" x 18 7/8" x 15 5/8" (160 x 480 x 395 mm)
51502140	Portero, 2 baskets	Gray/chrome	11 1/4" x 18 7/8" x 15 5/8" (285 x 480 x 395 mm)
5153140	Portero, 3 baskets	Gray/chrome	11 1/4" x 18 7/8" x 20 1/8" (285 x 480 x 510 mm)

*These are product dimensions, add clearance required for the hinges.



LEMANS II

- Height-adjustable shelves.
- Arena shelves are equipped with an anti-slip melamine surface ensuring noise reduction during operation.
- Shelves can be pulled out independently.
- Soft-closing mechanism available: to be ordered separately.
- Leaf-shaped shelves designed to maximize space and increase storage surface.
- Weight capacity : 55 lb (25 kg) per shelf.
- Available in 5 finishes: gray/chrome, maple/chrome, maple/champagne, white/chrome or anthracite/chrome.

SWINGS LEFT

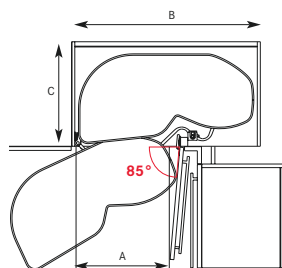

SWINGS RIGHT

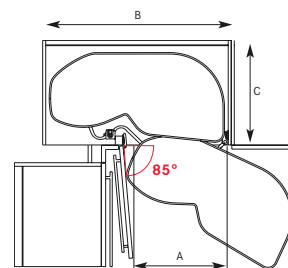

Soft-closing mechanism
No. 693802100
 (for right opening system)
 or **No. 693803100**
 (for left opening system)

Each set includes 2 shelves.
 Shelves should be positioned above
 or below the door hinges.
 Door opening required: 85 degrees



No. 6930100
 Filler strips



No. 693630
 Opening angle
 restriction device

NO.	DESCRIPTION	MIN. OPENING FACE FRAME (A)	MIN. OPENING FRAMELESS (A)	MIN. INTERIOR WIDTH (B)	MIN. INTERIOR DEPTH (C)	MIN. INTERIOR HEIGHT
6936-6937 series	400	14" (355mm)	14 1/4" (362mm)	30 11/16" (780mm)	19 11/16" (500mm)	21 7/16" (545mm)
6930-6931 series	450	16 1/8" (410 mm)	16 1/2" (419 mm)	32 1/4" (820 mm)	19 3/4" (500 mm)	21 1/2" (545 mm)
6932-6933 series	500	17 3/4" (450 mm)	18 3/8" (467 mm)	36 1/4" (920 mm)	19 3/4" (500 mm)	21 1/2" (545 mm)
6934-6935 series	600	21 1/4" (540 mm)	22 1/4" (565 mm)	38" (965 mm)	19 3/4" (500 mm)	21 1/2" (545 mm)



No. 2504100
 Highboard
 silver gray
 post for
 4-shelf
 application
 H : 49 7/8"
 (1265 mm)

DESCRIPTION	OPENING	GRAY/ CHROME	MAPLE/ CHROME	MAPLE/ CHAMPAGNE	WHITE/ CHROME	ANTHRACITE/ CHROME
400	Right	6936140100	6936140150	6936155150	693614030	6936140906
400	Left	6937140100	6937140150	6937155150	693714030	6937140906
450	Right	6930140100	6930140150	6930155150	693014030	6930140906
450	Left	6931140100	6931140150	6931155150	693114030	6931140906
500	Right	6932140100	6932140150	6932155150	693214030	6932140906
500	Left	6933140100	6933140150	6933155150	693314030	6933140906
600	Right	6934140100	6934140150	6934155150	693414030	6934140906
600	Left	6935140100	6935140150	6935155150	693514030	6935140906
Soft stop	Right	693802100	693802100	693802100	693802100	693802100
Soft stop	Left	693803100	693803100	693803100	693803100	693803100



BASE CORNER CABINET



MAGIC CORNER U.S.

- Opens in one movement: pull out the door, the front shelves will slide forward and out to one side while the rear shelves will move into the cabinet opening, giving you complete access.
- Frames available with right or left side opening.
- Sets of Arena shelves with anti-slip melamine surface are available in 3 finishes: gray/chrome, maple/chrome or maple/champagne.
- Frames are available in 2 finishes: gray or champagne.
- Equipped with a soft-closing mechanism.
- Front fixing brackets are included with the frame.
- Weight capacity:
19 lb (9 kg) per shelf (rear),
15 lb (7 kg) per shelf (front).

FOR A COMPLETE SET, ORDER:
1 frame (left or right)
+ 2 sets of trays
(1 set for the front and 1 for the back)

RIGHT OPENING

Frame

DESCRIPTION	NO.	FINISH
Right opening	3894110	Gray
Left opening	3895110	Gray

DESCRIPTION	NO.	FINISH
Right opening	3894155	Champagne
Left opening	3895155	Champagne

Shelves

DESCRIPTION	NO.	DIMENSIONS (WxDxH)	FINISH	APPLICATION
Set of 2 front shelves	2556140100	11 5/8" x 18 1/2" x 3 1/2" (295 x 470 x 88 mm)	Gray/chrome	Front
Set of 2 rear shelves	2557140100	15 3/8" x 18 1/2" x 3 1/2" (390 x 470 x 88 mm)	Gray/chrome	Rear or front
Set of 2 front shelves	2556140150	11 5/8" x 18 1/2" x 3 1/2" (295 x 470 x 88 mm)	Maple/chrome	Front
Set of 2 rear shelves	2557140150	15 3/8" x 18 1/2" x 3 1/2" (390 x 470 x 88 mm)	Maple/chrome	Rear or front
Set of 2 front shelves	2556155150	11 5/8" x 18 1/2" x 3 1/2" (295 x 470 x 88 mm)	Maple/champagne	Front
Set of 2 rear shelves	2557155150	15 3/8" x 18 1/2" x 3 1/2" (390 x 470 x 88 mm)	Maple/champagne	Rear or front

SWINGS LEFT

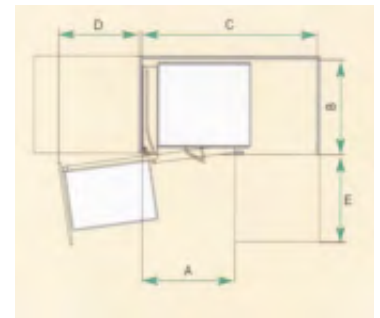

B: Interior depth
min. 19 11/16" (500 mm)

C: Interior width
from 37 13/16" to 42 3/16"
(960 to 1071 mm)

Int. height: min. 21 1/4" (540 mm)

D: 16 1/2" (419 mm)

E: 29 1/8" (740 mm)

On front, 1 set/2 shelves **No. 2556XXXXXX**: opening required (A) min. 15 5/8" (395 mm) or 1 set/2 shelves **No. 2557XXXXXX**: opening required (A) min. 19 5/16" (490 mm)

On rear, use 1 set/2 shelves **No. 2557XXXXXX**

Note: You have the option to use the wider rear shelves as front shelves but the back shelves can only use the wider rear shelves.

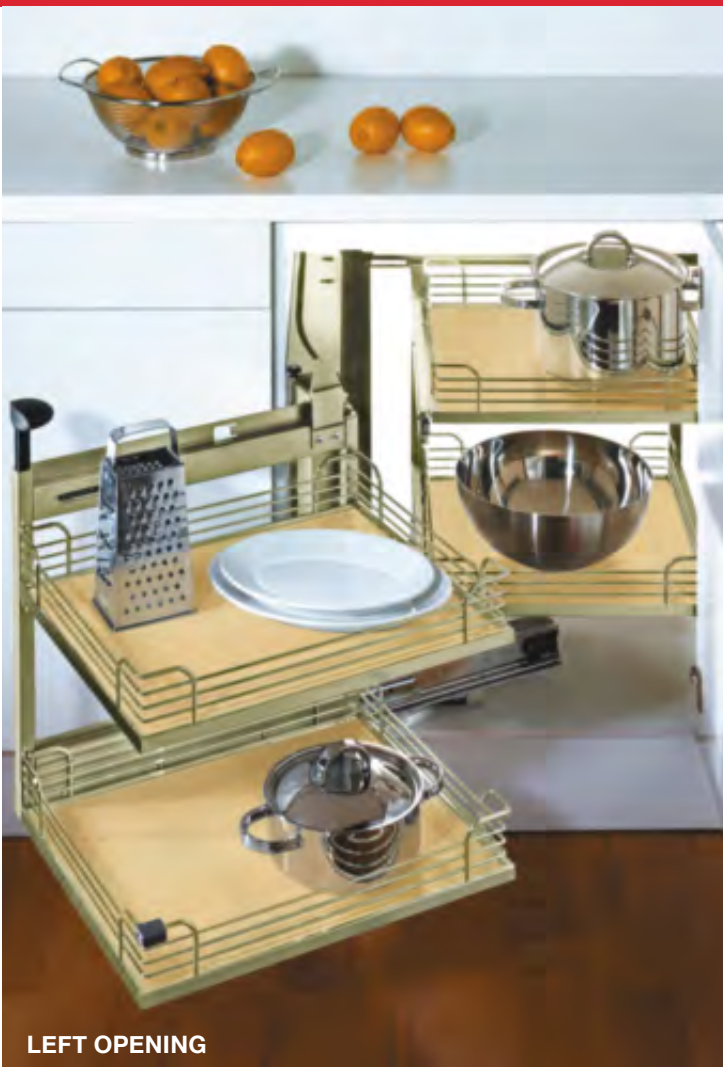

LEFT OPENING

MAGIC CORNER II

- The only system that allows you to bring out the complete cabinet interior outside!
- Ergonomic sliding technology lets the user access the front and rear shelves.
- Once the door is opened, front shelves can be pulled out completely and rear shelves can be pulled out individually.
- Arena shelves with anti-slip surface preventing pots, pans and groceries from sliding and therefore reducing noise.
- Equipped with a soft-closing mechanism.
- Height-adjustable handle for added comfort and ergonomics.
- Plastic protector clips onto the back shelves to prevent the cabinet door from being scratched.
- Suited for installation in cabinets with hinged doors.
- Weight capacity:
17 lb (8 kg) per shelf (rear),
22 lb (10 kg) per shelf (front).

FOR A COMPLETE SET, ORDER:
1 frame (left or right)
+ 1 set of 4 shelves

INT. HEIGHT	INT. WIDTH (C)	INT.DEPTH (B)	OPENING WIDTH (A)
Min. 21 1/2"	37 7/8" to 46 1/8"	Min. 20"	Min. 19 1/2"
(Min. 545 mm)	(962 to 1171 mm)	(Min. 500 mm)	(Min. 494 mm)

Frame

DESCRIPTION	NO.	FINISH
Right opening	30592155	Champagne
Left opening	30593155	Champagne

Shelves

DESCRIPTION	NO.	FINISH
Set of 4 shelves	30598155150	Maple/champagne

LEFT OPENING = SWINGS LEFT

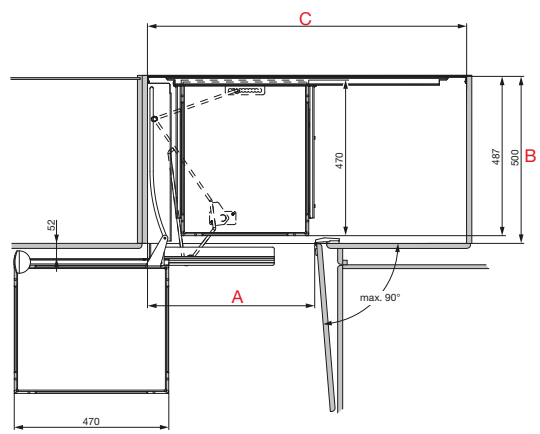



REVO U.S. SYSTEM

- With just a slight pressure, the two doors fold inward and rotate smoothly with the shelves inside the cabinet.
- Equipped with an adjustable soft-closing mechanism.
- Easy-to-install system thanks to its height-adjustable pole (660-860 mm or 26 in-33 13/16 in) (sold separately)
- Melamine trays with exclusive Arena non-slip finish



No. 6950100
Revo mechanism gray



White/chrome tray



Grey/chrome tray



Maple/chrome tray

Set of Two REVO US Trays

NO.	FINISH
6863140030	White/chrome
6863140100	Gray/chrome
6863140150	Maple/chrome
6863155150	Maple/champagne



Maple/chrome super Susan

KIDNEY LAZY SUSANS AND SUPER SUSANS

- Suitable for base corner cabinets.
- Designed to maximize storage space.
- Each shelf is made of an anti-slip melamine surface with metal surround, ensuring noise reduction during operation.
- Shelves are pivoting independently for easier access.
- Weight capacity: 55 lb (25 kg) per shelf.



For kidney Susans mounted with a post: choose your type of post A or B and select 1 set/2 kidney shelves C or D.

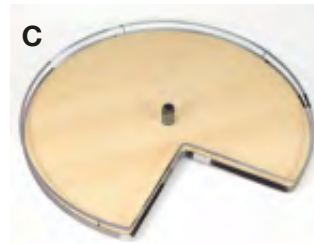

For super Susans with swivel: choose 1 set/2 shelves E, F or G.



Post

NO.	DESCRIPTION	INTERIOR HEIGHT	FINISH
A 251140140	Bottom-mounted post	Min. 18 13/16" (477 mm)	Chrome
B 252140140	Top- & bottom-mounted adjustable post	25 13/16" to 29 5/16" (656 to 744 mm)	Chrome

Set of 2 kidney shelves

NO.	DIAMETER	FINISH
C 254140150	28" (712 mm)	Maple/chrome
C 255140150	32" (813 mm)	Maple/chrome
D 254140100	28" (712 mm)	Gray/chrome
D 255140100	32" (813 mm)	Gray/chrome

Super Susan (swivel included) - Total Height: 3" Set of 2 shelves

NO.	DIAMETER	FINISH
E 2649140150	28" (712 mm)	Maple/chrome
E 2650140150	32" (813 mm)	Maple/chrome
F 2649140100	28" (712 mm)	Gray/chrome
F 2650140100	32" (813 mm)	Gray/chrome
G 2660155150	32" (813 mm)	Maple/champagne



SPICE PULL-OUT

- Pull-out shelves system for upper cabinets, ideal for the storage of spices, oils, cans, etc.
- Side-mounted, the frame can receive up to 4 Arena shelves, with a load capacity up to 18 lb (8 kg).
- Shelves can be adjusted in height, each shelf is made of anti-slip melamine surface and a chrome or champagne surround.
- Shelves are offered in set of 2 (2 different widths available).
- Possible combinations:
2 sets of 3" (77 mm) wide shelves,
2 sets of 5" (127 mm) wide shelves,
1 set of each.
- Reversible frame (left or right installation).

Framed cabinet

Opening width required: 1 1/4" (32 mm) + width of the widest shelf (use spacers if required).

Frameless cabinet

Internal width required: 1 1/4" (32 mm) + width of the widest shelf.

**FOR A COMPLETE SET, ORDER:
1 frame + 1 set of slides + sets of shelves
according to your needs. (use spacers if required)**

Frame and set of slides

GRAY	CHAMPAGNE	SET OF SLIDES	INTERIOR/OPENING HEIGHT
2579100	2579155	2578100	Min. 23 1/2" (596 mm)

Set of 2 shelves

NO.	SHELF DIMENSIONS (WXDXH)	FINISH
2581140100	3" x 9 7/8" x 2 3/4" (77 x 251 x 70 mm)	Grey/Chrome
2581140150	3" x 9 7/8" x 2 3/4" (77 x 251 x 70 mm)	Maple/chrome
258114030	3" x 9 7/8" x 2 3/4" (77 x 251 x 70 mm)	White/chrome
2581155150	3" x 9 7/8" x 2 3/4" (77 x 251 x 70 mm)	Maple/champagne
2582140100	5" x 9 7/8" x 2 3/4" (127 x 251 x 70 mm)	Grey/Chrome
2582140150	5" x 9 7/8" x 2 3/4" (127 x 251 x 70 mm)	Maple/chrome
258214030	5" x 9 7/8" x 2 3/4" (127 x 251 x 70 mm)	White/chrome
2582155150	5" x 9 7/8" x 2 3/4" (127 x 251 x 70 mm)	Maple/champagne



No. 60285012
1" (25 mm) spacer

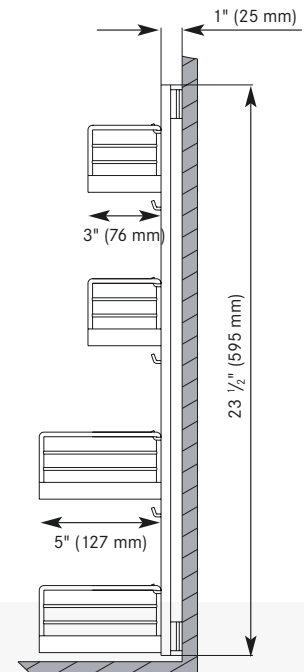

Min. interior depth required: 11" (280 mm)



TWISTER

- Suitable for upper 45° corner cabinets.
- Pole located at the rear of the shelves offering larger storage space and better access.
- Height-adjustable pole.
- Arena shelves with anti-slip surface.
- Weight capacity per shelf: 18 lb (8 kg).
- Optimal D-shape for storage maximization.



NO.	DESCRIPTION	INTERIOR HEIGHT	DIAMETER	FINISH
2561140100	Twister 2 shelves	25 15/16" to 30 1/2" (658 to 774 mm)	19 11/16" (500 mm)	Gray/chrome
2562140100	Twister 3 shelves	32" to 36 1/2" (812 to 927 mm)	19 11/16" (500 mm)	Gray/chrome
2591140100	Twister 3 shelves	38" to 42 1/4" (965 to 1073 mm)	19 11/16" (500 mm)	Gray/chrome
		Min. interior depth: 22 1/8" (562 mm)		

NO.	DESCRIPTION	INTERIOR HEIGHT	DIAMETER	FINISH
2561140150	Twister 2 shelves	25 15/16" to 30 1/2" (658 to 774 mm)	19 11/16" (500 mm)	Maple/chrome
2562140150	Twister 3 shelves	32" to 36 1/2" (812 to 927 mm)	19 11/16" (500 mm)	Maple/chrome
2591140150	Twister 3 shelves	38" to 42 1/4" (965 to 1073 mm)	19 11/16" (500 mm)	Maple/chrome
		Min. interior depth: 22 1/8" (562 mm)		

NO.	DESCRIPTION	INTERIOR HEIGHT	DIAMETER	FINISH
2561155150	Twister 2 shelves	25 15/16" to 30 1/2" (658 to 774 mm)	19 11/16" (500 mm)	Maple/champagne
2562155150	Twister 3 shelves	32" to 36 1/2" (812 to 927 mm)	19 11/16" (500 mm)	Maple/champagne
2591155150	Twister 3 shelves	38" to 42 1/4" (965 to 1073 mm)	19 11/16" (500 mm)	Maple/champagne
		Min. interior depth: 22 1/8" (562 mm)		



PULL-DOWN MECHANISMS



I-MOVE PULL-DOWN SYSTEM FOR FRAMED OR FRAMELESS CABINETS

Facilitates access to usually hard-to-reach objects at the top of cabinets.

- Available in single and double shelf version.
- Available shims for face frame application.
- 2 finishes available: silver/anthracite or silver/maple
- Soft opening and closing.
- Fits cabinets from 21" to 30" (533 to 762 mm).
- Weight capacity - single shelf version: 17.6 lb (8 kg).
- Weight capacity - double shelf version: 8.8 lb (4 kg) per shelf, total 17.6 lb (8 kg).



Silver/anthracite



Silver/maple

FOR FRAMED CABINETS

NO.	DESCRIPTION	MIN. OPENING WIDTH	FINISH
2125100906	Double shelf	18" (457 mm)	Silver/anthracite
2125100150	Double shelf	18" (457 mm)	Silver/maple
2425100906	Double shelf	21" (533 mm)	Silver/anthracite
2425100150	Double shelf	21" (533 mm)	Silver/maple
3015100906	Single shelf	27" (686 mm)	Silver/anthracite
3015100150	Single shelf	27" (686 mm)	Silver/maple

FOR FRAMELESS CABINETS

NO.	DESCRIPTION	MIN. OPENING WIDTH	FINISH
2420100906	Double shelf	22 1/2"- 22 3/4" (572-578 mm)	Silver/anthracite
2420100150	Double shelf	22 1/2"-2 3/4" (572-578 mm)	Silver/maple
3010100906	Single shelf	28 1/2"- 28 3/4" (724-730 mm)	Silver/anthracite
3010100150	Single shelf	28 1/2"- 28 3/4" (724-730 mm)	Silver/maple

Other versions and dimensions available on special order.



STRAIGHTLINE

The advantages are clear: the flexibility of the Straightline range of products is perfectly adapted to all drawer size.

- More than 20 versatile components.
- Flexible: elements combined and arranged to suit end user's storage requirements.
- Allows for a harmonized interior design.
- Many storage applications: spices, cutlery, utensils.
- Standard and deep drawers applications.
- Available in birch, walnut & black ash.

See our website for suggested pre-configured WEBKITS.



Trimnable drawer mats (recommended for each application)

Dimensions (WxDxH):
43 1/4" x 23 5/8" x 1/16"
(1100 x 600 x 1.5 mm)

NO.	FINISH
6115202040	Taupe
6115211100	Gray
6115212906	Anthracite
6115217090	Black

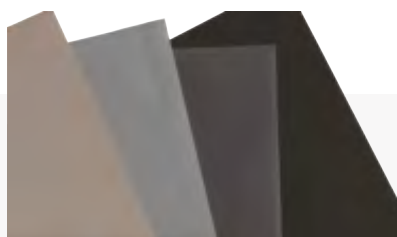

NO.	FINISH
6115211007	Clay
6115211060	Brown
6115211117	Green sage
6215212906	Anthracite antibacterial

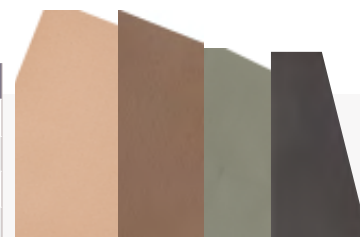



STRAIGHTLINE MODULAR WOODEN DIVIDER SYSTEM

DRAWER ORGANIZATION



A CUTLERY DIVIDER



B MULTIFUNCTIONAL DIVIDER



C CROSS DIVIDER

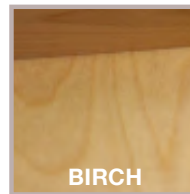

BIRCH

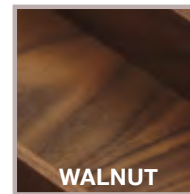

WALNUT

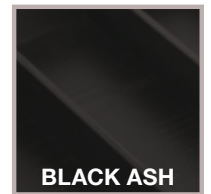

BLACK ASH



D SPICE DIVIDER



E KNIFE BLOCK DIVIDER

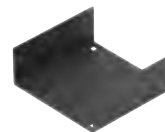

No. 250547910*
U shape metallic divider
Graphite

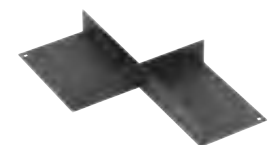

No. 250549910
Cross metallic divider
Graphite

DESCRIPTION	DIMENSIONS (WxDxH)	BIRCH	WALNUT	BLACK ASH
A Cutlery divider	11 13/16" x 16 11/16" x 1 11/16" (300 x 424 x 43 mm)	250526031	250526161	250526900
B Multifunctional divider	6" x 16 11/16" x 1 11/16" (152 x 424 x 43 mm)	250530031	250530161	250530900
C Cross divider	5 3/8" x 16 11/16" x 1 1/2" (137 x 424 x 37.5 mm)	250532031	250532161	250532900
D Spice divider	5 3/8" x 16 11/16" x 1 9/16" (137 x 424 x 26 mm)	250533031	250533161	250533900
E Knife block divider	5 3/8" x 16 11/16" x 1 9/16" (137 x 424 x 26 mm)	250534031	250534161	250534900



A WRAPPING FILM DISPENSER



B DEPTH EXTENSION

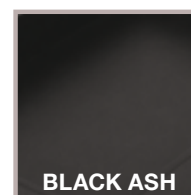
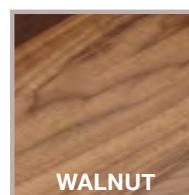
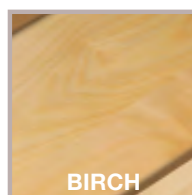

C SMALL TRAY



D LARGE TRAY



No. 250529010
Connection clip
Aluminum

	DESCRIPTION	DIMENSIONS (WxDxH)	BIRCH	WALNUT	BLACK ASH
A	Wrapping film dispenser	5 3/8" x 16 11/16" x 1 1/2" (137 x 424 x 37.5 mm)	250535031	250535161	250535900
B	Depth extension	47 1/4" x 4 1/8" x 1 11/16" (1200 x 104.5 x 43 mm)	250528031	250528161	250528900
B	Depth extension	23 5/8" x 4 1/8" x 1 11/16" (600 x 104.5 x 43 mm)	250527031	250527161	250527900
B	Depth extension	36" x 4 1/8" x 1 11/16" (914 x 104.5 x 43 mm)	250555031	250555161	250555900
C	Small tray	11 13/16" x 4 1/8" x 1 11/16" (300 x 105.5 x 43 mm)	250531031	250531161	250531900
D	Large tray	11 13/16" x 8 5/16" x 1 11/16" (300 x 211 x 43 mm)	250540031	250540161	250540900



STRAIGHTLINE MODULAR WOODEN DIVIDER SYSTEM

DRAWER ORGANIZATION



A PEG BOARD



BIRCH

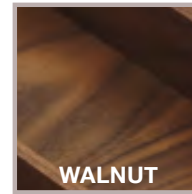

WALNUT



BLACK ASH



B SET OF 4 PEGS



C SMALL DIVIDER



D LARGE DIVIDER

DESCRIPTION	DIMENSIONS (WxDxH)	BIRCH	WALNUT	BLACK ASH
A Peg board	33 1/2" x 22" x 3/8" (851 x 559 x 9 mm)	250541031	250530161	250541900
B Set of 4 pegs	1" x 1" x 6 5/16" (25 x 25 x 160 mm)	250544031	250544161	250544900
C Small divider	7 1/2" x 1 1/2" x 4 3/4" (190 x 12 x 120 mm)	250545031	250545161	250545900
D large divider	5 3/8" x 16 11/16" x 1 9/16" (137 x 424 x 26 mm)	250546031	250546161	250546900



A BOX WITH HANDLES



B SQUARE BOX WITH HANDLES

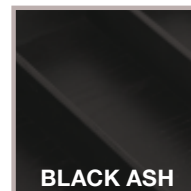
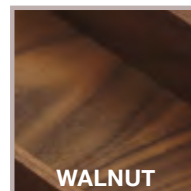
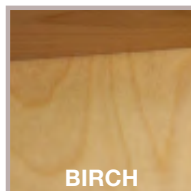

C PLATE HOLDER



Metal divider with handles

NO.	DIMENSIONS (WxDxH)	FINISH
250548910	7 5/8" x 3 7/8" x 4" (194 x 99 x 102 mm)	Graphite



No. 250543990
Anti-slip bumpers*
(black)

Anti-slip bumpers to clip under the metal dividers
To be used with
No. 250547910, No. 250549910
and **No. 250548910**

*Sold in bag of 25 units.

	DESCRIPTION	DIMENSIONS (WxDxH)	BIRCH	WALNUT	BLACK ASH
A	Box with handles	8 3/8" x 16 11/16" x 4 5/16" (212 x 424 x 110 mm)	250538031	250538161	250538900
B	Square box with handles	8 3/8" x 8 3/8" x 4 5/16" (212 x 212 x 110 mm)	250539031	250539161	250539900
C	Plate holder	13 3/8" x 7 1/16" x 7 1/2" (340 x 180 x 191 mm)	009197031	009197161	009197900



ARENA PLUS KITCHEN ACCESSORIES



Serving you across North America

UNITED STATES

Tel.: 1 800 619-5446

Fax: 1 800 876-7454

www.richelieu.com



ARENA102021 02-2022
Printed in Canada \$5