

Aria[®]
Metal Hardware



2025 product catalog

Contents

see what's new

new

Our *new* curved French Return elbows for H-Rail Traverse allow panels to wrap all the way to the wall for a clean transitional look and can be paired with our French Return Bands to help reduce sidelight. Available in both 1 1/8" and 1 3/8" diameters, in Matte Black only - *pages 13, 21, 39.*



Additionally, pair our *new* modern Matte Black Round Grommets and Grom-A-Link™ with Fixed or Telescoping Poles. Available to work with both diameters in either #12 or #15 sizes - *pages 62 - 63.*

style meets function

- Automated 1 3/8" H-Rail Traverse Systems integrate smart solutions using the Automate Pulse 2 Hub and App for voice control
- Baton Draw 1 1/8" or 1 3/8" H-Rail Traverse Systems can now be paired with *new* Traverse French Returns to lessen light gap
- Fixed or Telescoping Poles with rings or grommets
- No physical operating cords, ensuring the ones we care about most are protected and safe 🙌



Automated H-Rail
1 3/8" dia
pages 4 - 15



Baton Draw H-Rail
1 1/8" - 1 3/8" dia
*pages 16 - 23,
34 - 41*



Fixed
1 1/8" - 1 3/8" dia
*pages 30 - 33,
56 - 59*



Telescoping
1 1/8" dia
pages 56 - 59

collections

The AriA® Metal Hardware line offers trend-right designer hardware collections across two pole diameter options providing a beautiful range of finial designs and a full line of coordinating accessories. No matter the style, we've got the perfect finial to complement it. OUR VISION: *Elevating windows with a finishing touch.*



Antiquities
Traditional
1 3/8" dia
pages 24 - 29



Atelier
Modern
1 1/8" dia
pages 42 - 47



Artisan
Eclectic
1 1/8" dia
pages 48 - 51



Abode
Transitional
1 1/8" dia
pages 52 - 55



French Returns
for Stationary
1 1/8" dia
pages 60 - 61



French Returns
for Traverse
1 1/8" - 1 3/8" dia
pages 13, 21, 39

sales tools



Automated Display Kit RTMDK (Case & Kit*)

*Controls not included; see pages 9 - 11 for selection.

Order modules separately:

AriA® 1 3/8" H-Rail Module - RTMDK/FMH

Drapery Motor + Battery Kit - RTMLDKIT



1 3/8" Antiquities Table Top Display FMTT138AN



1 3/8" Antiquities Wall Mount Display FM4138/W

Automated Retro Wall Mount Display CSRTMFMH138/W



1 3/8" Antiquities Finish Sample Ring FM138FS/1



1 1/8" Atelier Table Top Display FMTT118AT



1 1/8" Atelier Wall Mount Display FM3A118/W



1 1/8" Artisan Portable Display Kit FMPDK/1



1 1/8" Artisan Table Top Display FMTT118AR



1 1/8" AriA Wall Mount Display FM4118/W



1 1/8" Finish Sample Ring - FMFS/4
1 1/8" Atelier Retro Finish Sample Ring - FMRFS/1



1 1/8" Abode Table Top Display FMTT118AB

our automated 1 3/8"

H-Rail Traverse

The automated 1 3/8" H-Rail Traverse Collection combines automated technology with the beauty of AriA® Metal Hardware, integrating smart solutions designed for residential and commercial environments.

No physical operating cords, ensuring the ones we care about most are protected and safe. 

unrivaled design

Automated products are meticulously designed to combine beauty, form and function with superior performance.

intuitive programming

Controls offer modern design and lifestyle options with easy programming and the ability to integrate with the latest smart home solutions.

uncompromising quality & service

We proudly stand behind our products by providing expert services to support you along with a slim drapery motor backed by a 5 year warranty.

unsurpassed value

Provide your clients with innovative window treatment solutions that fit their budget expectations with automated drapery and shade systems.

View compatible Automated Shade Systems »



powered by

AUTOMATE®

A DIVISION OF ROLLEASE ACMEDA

Automated 1 3/8" H-Rail Traverse

finishes



Polished Nickel
PN

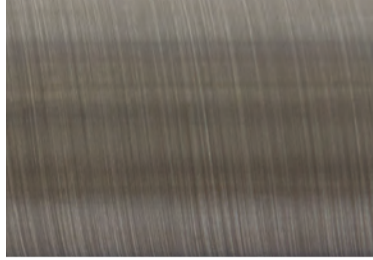

Antique Pewter
AP



Iron Copper
IC



Antique Brass
AB



Brushed Bronze
BZ



Oil Rubbed Bronze
ORB



Satin Black
SK



Matte Black*
MK

**coordinates with VZ & DRB finials*



VZ



DRB

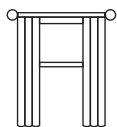

Let Rowley[®] do the work for you with **Custom Solutions**

Use our online [DESIGN your WINDOW ▶](#) feature!



system styles

Li-ion Battery or 110v AC/DC Power Transformer, Ripplefold or Pinch Pleat. Lengths up to 12' continuous (select finishes) and 24' spliced. Lengths over 8' will ship via truck and incur an oversized  fee.

single



1 3/8" single wall mount

- 3 1/2" or 6" projection

double



1 3/8" double wall mount

- 3" and 7 1/2" projection



1 3/8" single ceiling mount

- 2 3/8" drop
- 2" Ceiling Bracket Extender available

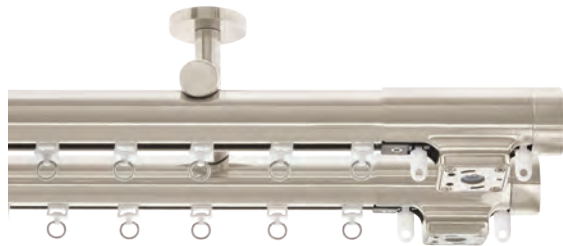

1 3/8" double ceiling mount

- 2 5/8" drop, 4 1/2" apart
- 2" Ceiling Bracket Extender available



1 3/8" single low profile ceiling mount

- 5/32" drop

1 3/8" H-Rail Traverse Systems include Plain End Caps FMH138104/, but are designed to work with all 1 3/8" Antiquities Finials on pages 24 - 29 or our *new* French Returns for Traverse on page 13.

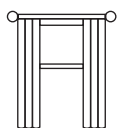

Let Rowley® do the work for you with **Custom Solutions**

Use our online [DESIGN your WINDOW](#) feature!



what's included



Automated 1 3/8" H-Rail Track(s) with Pulleys, Plain End Caps, Brackets, Components, Motor(s), & Power Option(s). Finalists and Control & Integration sold separately - see pages 14 - 15 for **Custom Solutions** details.



slim drapery motor

- 1 per H-Rail track
- Maximum drapery weight for Slim Drapery Motor: 77 lbs
- Maximum track length for Slim Drapery Motor: 24'
- Power option: Li-ion Battery (includes Battery Charger & USB Cable) or 110v AC/DC Power Transformer (includes 10' cord with 3 Conductor Male Plug) - see page 8 for details and features
- Motor can be mounted on right or left for center draw
- Available in white
- 5 year warranty

H-Rail track

- Maximum continuous length is 12' (select finishes); spliced lengths up to 24' (maximum of 2 splices per H-Rail Traverse Track System); min. system length is 37"
- Available in all finishes shown on page 5
- Brackets on page 19

Automated 1 3/8" H-Rail Traverse

AUTOMATE®

motor & power options

The Slim Drapery Motor boasts interchangeable power sources and versatile mounting to ensure a luxurious and elegant finish for your drapes. Select from Li-ion Battery or 110v AC/DC powered.

Slim Drapery Motor
MT01-2101-069002



li-ion battery powered



Li-ion Battery
MT03-0305-069004



USB Battery Charger
MT03-0301-069008

USB/Micro USB
Charger Cable
MT03-0301-069007



ECO
friendly

Solar Panel Battery Charger
*sold separately; includes L-Bracket, Fasteners,
Micro USB & USB C Cables - An eco-friendly
option that supplements the battery using solar
energy when available (note: it cannot recharge
a fully drained battery)*
MT03-0302-067002

110v AC/DC powered



110v AC/DC Power Transformer 10' *plug included*
MT03-0305-069005



110v AC/DC Power Transformer 20' *plug*
MTAC-FIELDPLUG not included - sold separately
MT03-0305-069006



18 Channel Power Distributor
*(requires 16/2 to 24/2 gauge cable hookup.
Cable not sold by Rowley®. Refer to the product
info sheet for cable size at bit.ly/18-ch-dist-cable)*
MT03-0301-411005

Adapters for Slim Drapery Motor to
Power Distributor
MT03-0304-050007

features



2-way RF communication

Integrated radio frequency control allows for easy programming of individual, group or all control across window treatments.



adjustable speed

Choose from three options to customize the open / close speed of the drapery treatment.

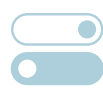

preferred open / close limit settings

Electronic "autoset" limits accurately program preferred open and close limit settings.



favorite position

Allows a most used or favorite position to be set between open and close limit settings.



obstruction detection

If the drapery motion is obstructed while the motor is running, the motor stops automatically to prevent damage.



manual override

Permits the drapery to be adjusted manually without the use of a remote or in the event of a power outage.



quiet operation

Powerful, smooth and quiet operation suitable for both residential and commercial environments.

controls

Opt for Remote Controls or Wall Switches. Handheld Remotes offer modern features, including LCD displays, individual, group and all control and precision leveling, giving users complete control. Wall Switches come in both cut in and flush mount configurations and provide a sensible control option for room and whole home control.



Push1 Handheld Remote with Wall Mount, 1 Channel
White or Black
Range: 65'
MT02-0101-067010
MT02-0101-050010



Push5 Handheld Remote with Wall Mount, 5 Channel
White or Black
Range: 65'
MT02-0101-067004
MT02-0101-050004



Push15 Handheld Remote with Wall Mount, 15 Channel
White or Black
Range: 65'
MT02-0101-067008
MT02-0101-050008



Surface Mount Wall Switch, 5 Channel
White
Range: 65'
MTRF-WS5-FLUSH



Cut-In Wall Mount Switch, 1, 2 or 15 Channel
Requires RTMSMB/W for installation
White
Range: 65'
MTRF-WS-1C
MTRF-WS-2C
MTRF-WS-15



Surface Mount Wall Back Box for Cut-In Style Remotes
White
RTMSMB/W



Interior Sun Sensor
Range: 65'
MTRF-SUNSENS



ARC USB Signal Repeater
Extends the wireless range of the Automate® Pulse 2 Hub and Remotes up to 60'
Maximum 2 repeaters per system or network
MT02-0401-069007



Wall Charger for USB Signal Repeater
MT03-0301-069008

Automated 1 3/8" H-Rail Traverse

smart control

Experience the Automate® brand on the Bond Home App. The Bond Home App is the leading platform for remote-controlled motorized window treatments along with the below Bond Bridge Pro. Control your devices from anywhere, including when offline, so you can manage your home seamlessly, even when you're away.

Streamline your R-TEC Automation® and Automate® Motors in one App. View compatible Automated Shade Systems »



bond Bridge PRO

Bond Bridge Pro
2-way RF, Wi-Fi built in
Range: 3,500 sq. ft.
BD-1750



bond

Download the Bond Home App »



Bond Bridge Pro smart home functionality adds Wi-Fi to your draperies, enabling seamless control with various smart home platforms and home automation systems. Slider easily opens and closes your treatments to desired percentage.

home automation systems

CRESTRON HOME™



Control4
CERTIFIED



SAVANT

smart home platforms



voice assistants



For a full list of integration platforms and support, scan & learn »



smart control

The Automate® Pulse 2 Hub is the foundation of your smart drapery motorization system.

Alongside the Automate® Pulse 2 App, the hub enables operation and automation of all ARC (Automate Radio Communication) enabled motors so that you can experience convenient drapery control straight from your smart device.

Automate® Pulse 2 Hub
2-way RF, Wi-Fi built in
Range: 60'
MT02-0401-067001

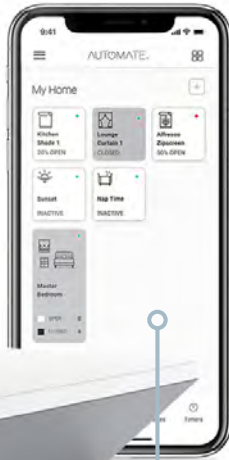

Download the Automate® Pulse 2 App »



ROOMS
Group Automate® window treatments by room and conveniently control them accordingly.



TIMERS
Set and forget. Lower, raise and activate window treatment scenes automatically at the optimal time.



SCENES
Personalize window treatment control and organize how your window treatments operate by specific daily events.



MULTIPLE TREATMENT TYPES
Pinch pleat draperies, Ripplefold draperies, Roman shades and roller shades ... control every window treatment application from one screen.



The hub seamlessly integrates with a variety of smart home platforms and home automation systems, so that you can take full advantage of customized automation and voice-activation when operating your Automate® smart draperies.

home automation systems



smart home platforms



voice assistants



For a full list of integration platforms and support, scan & learn »



Automated 1 3/8" H-Rail Traverse

carriers

1 3/8" Automated H-Rail Traverse Systems work with Pinch Pleat and Ripplefold Roller Carriers.

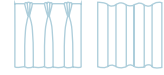

Master Carrier Body *required for each Master Carrier Arm*
White
RTFMH138MCB



Pinch Pleat / Ripplefold
Master Carrier Arms
Center Draw, Pair
RTFMH138CD



Ripplefold Butt Master
Carrier Arms
Center Draw, Pair
RTMDTCDB



Pinch Pleat Master
Carrier Arm
One-Way Draw, Right
RTFMH138PPOR or
Left RTFMH138PPOL



Ripplefold Butt Master
Carrier Arm
One-Way Draw, Right
RTFMH138OBR or Left
RTFMH138OBL



Pinch Pleat Carriers
CP40



Ripplefold Roller Carriers
R4060/ - 60% fullness R4100/ - 100% fullness
R4080/ - 80% fullness R4120/ - 120% fullness



**For more details on Pinch Pleat and Ripplefold carriers, please see the price list.*

accessories



H-Rail Splice
FMH138407

Automated 1 3/8" H-Rail Traverse

finials & end caps

Antiquities collection

1 3/8" H-Rail Traverse Systems are designed to work with all AriA® 1 3/8" Antiquities Finials on pages 24 - 29.

Plain End Caps FMH138104/ included; order our Saxon End Cap FM138190/ or Avalon End Cap FM138191/ for a more stylized look, or select from 10 finial designs.

Choose from 9 multi-pass finishes on page 25 (Plain and Saxon End Caps also available in Matte Black*).



Plain End Cap*
FMH138104/
shown in PN



Saxon End Cap*
FMH138190/
shown in MK



Avalon End Cap
FMH138191/
shown in AP

introducing our traverse french returns

new

Our *new* curved French Return elbows for H-Rail Traverse allow panels to wrap all the way to the wall for a clean transitional look and can be paired with our French Return Bands to help reduce sidelight.

Available in Matte Black only. Includes H-Rail Return & Splice, Band, End Stops and Pinch Pleat & Ripplefold Carriers.



new

1 3/8" French Return for H-Rail Traverse
3 1/2" projection
FMH138440/MK

**H-Rail Track sold separately.*



1 3/8" French Return Band

**Use to secure the drapery, ensuring minimal light gap.*





Let Rowley® do the work for you with *Custom Solutions*

- Our in-house experts will fully assemble your AriA® Automated 1 3/8" H-Rail Traverse System(s), custom cut to your exact specification.
- Attach with ease - your system arrives, prepared for the seamless addition of your drapery.
- Previously purchased Manual Baton Draw H-Rail Systems cannot be automated.
- Includes 1 3/8" H-Rail Track(s), Motor(s), Power Option(s), Drive Belt & Clips, Pulleys, Pendants, Carriers, Brackets, Master Carriers, Plain End Caps, labor & packaging.
- See [pages 9 - 11](#) for control options - sold separately.
- Antiquities Finials or our *new* French Returns for Traverse on [page 13](#) sold separately.
- Lengths up to 12' continuous (select finishes) and 24' spliced; minimum length is 37" excluding Finials.
- Pinch Pleat or Ripplefold.
- Ceiling or Wall Mount.
- Lengths over 8' will ship via truck and incur an oversized  fee.

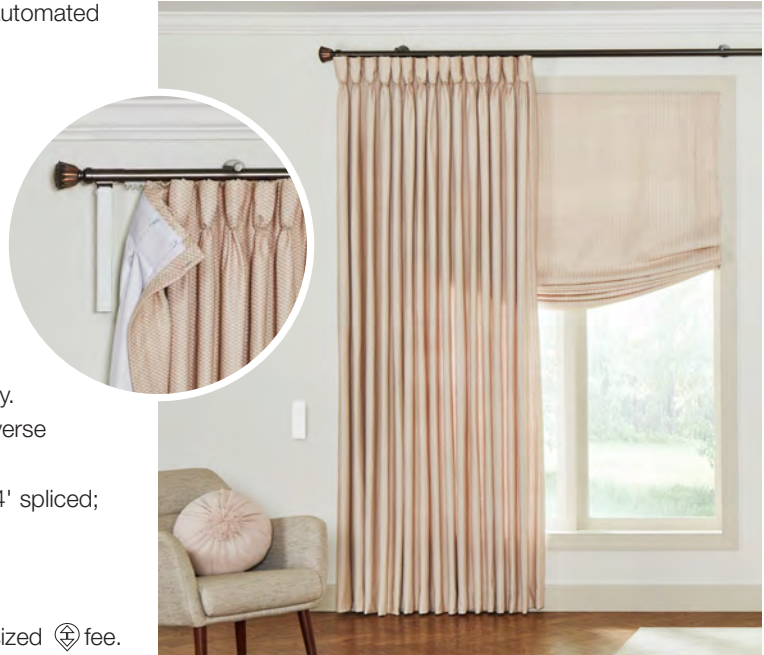

Order using the *Custom Solutions* order form



or online using our

DESIGN your WINDOW ▶

feature »



**Custom Solutions are final sale, non-returnable.*

how-to order

1 – CHOOSE YOUR SYSTEM QUANTITY & LENGTH

Let our in-house experts know how many systems to assemble, custom cut to your exact specification. Minimum 37" excluding Finials. Lengths up to 12' continuous (select finishes) and 24' spliced.

2 – CHOOSE YOUR SYSTEM STYLE

Select from Single or Double, Ceiling or Wall Mount, with various projection options.

3 – CHOOSE YOUR H-RAIL FINISH & FINIALS

Select from 8 finishes that coordinate with our Antiquities Finials or French Returns (sold separately) - see [pages 12 - 13](#).

4 – CHOOSE YOUR MOTOR POWER

Select from Li-ion Battery or 110v AC/DC Power Transformer.

5 – CHOOSE YOUR DRAPERY STYLE, DRAW & MASTER CARRIER

Select from Pinch Pleat or Ripplefold; One-Way Draw Right or Left, or Center Draw; Overlap Master Carriers are standard, or Butt Master Carrier option can be substituted if Ripplefold Drapery Style is selected.

PINCH PLEAT

- Carriers available in White. Please specify number of carriers.



RIPPLEFOLD

- Carriers available in White. 60%, 80%, 100% or 120% fullness available; please specify fullness on order.
- Butt Master Carriers available, allowing some light to filter between draperies on center draw treatments.



6 – CHOOSE YOUR CONTROL & INTEGRATION

Controls sold separately - see [pages 9 - 11](#). Select from remotes or wall switches, or take your drapery control to the next level by upgrading to the Bond Bridge Pro & Bond Home App, or the Automate® Pulse 2 Hub & App, to integrate your draperies with whole home and voice control systems.

our manual baton 1 3/8"

H-Rail Traverse

1 3/8" Baton Draw H-Rail provides the perfect combination of fashion and function in a larger diameter, creating more sophisticated solutions for both residential and commercial environments. 



finishes

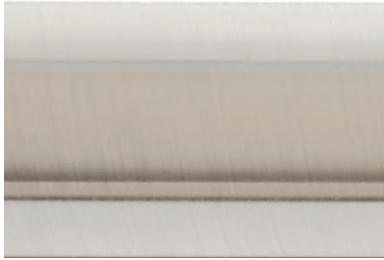

Polished Nickel
PN

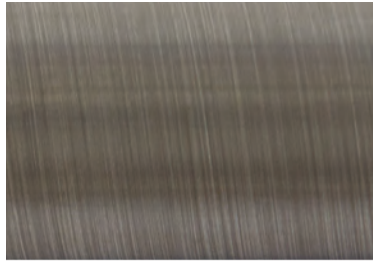

Antique Pewter
AP



Iron Copper
IC



Antique Brass
AB



Brushed Bronze
BZ



Oil Rubbed Bronze
ORB



Satin Black
SK



Matte Black*
MK

**coordinates with VZ & DRB finials*



VZ



DRB

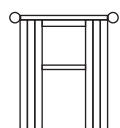

Let Rowley® do the work for you with **Custom Solutions**

Use our online [DESIGN your WINDOW ▶](#) feature!



system styles

Available lengths: 6', 8' & 12'. Maximum continuous length is 12' in all finishes except BZ, ORB or IC which is 8'. Longer lengths will be spliced up to 24'. Lengths over 8' will ship via truck and incur an oversized  fee.

Baton Draw. Pinch Pleat or Ripplefold. Components sold separately - see price list for options. How-To Order on [page 23](#). Include Plain End Caps & Brackets, and are designed to work with AriA® 1 3/8" Antiquities Finials or Traverse Returns.

single



1 1/8" single wall mount

H-Rail Track (1) with 3 1/2" or 6" Wall Brackets (4) for 6' & 8' kits, (5) for 12' kits and Plain End Caps (2)

- 3 1/2" projection - RTFMH138400/
- 6" projection - RTFMH138401/



1 1/8" single ceiling mount

H-Rail Track (1) with Ceiling Brackets (4) for 6' & 8' kits, (5) for 12' kits and Plain End Caps (2)

- 2 3/8" drop - RTFMH138403/
- 2" Ceiling Bracket Extender available



1 1/8" single low profile ceiling mount

H-Rail Track (1) with Low Profile Ceiling Brackets (4) for 6' & 8' kits, (5) for 12' kits and Plain End Caps (2)

- 5/32" drop - RTFMH138406/

double



1 1/8" double wall mount

H-Rail Tracks (2) with Double Wall Brackets (4) for 6' & 8' kits, (5) for 12' kits and Plain End Caps (4)

- 3" and 7 1/2" projection - RTFMH138402/

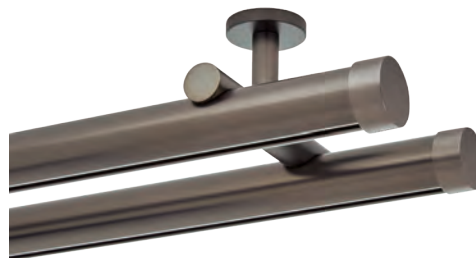

1 1/8" double ceiling mount

H-Rail Tracks (2) with Double Ceiling Brackets (4) for 6' & 8' kits, (5) for 12' kits and Plain End Caps (4)

- 2 5/8" drop, 4 1/2" apart - RTFMH138404/
- 2" Ceiling Bracket Extender available



1 1/8" mixed double wall mount

H-Rail Track (1) and Fixed Pole (1) with FM138400L and Collar Brackets (4) for 6' & 8' kits, (5) for 12' kits and Plain End Caps (4)

- 3 1/2" and 6 1/2" projection - FMH138408/



brackets

Easy to install - attach to H-Rail track with a set screw. Compatible with Automated H-Rail Systems (select brackets) and Manual Baton Draw H-Rail Traverse Kits.



H-Rail Wall Bracket
3 1/2" projection
FMH138400/



H-Rail Wall Bracket
6" projection
FMH138401/



H-Rail Double Wall Bracket
3" and 7 1/2" projection
FMH138402/



H-Rail Ceiling Bracket
2 3/8" drop
FMH138403/



H-Rail Double Ceiling Bracket
2 5/8" drop, 4 1/2" apart
FMH138404/



Ceiling Bracket Extender
2" projection
FMH138405/

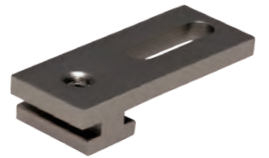

H-Rail Low Profile
Ceiling Bracket
5/32" drop
FMH138406/



H-Rail Collar Bracket
FMH138408/
Fits FM138400L/



Turned Bracket for Mixed
Double Rod *for Manual Baton
Draw H-Rail only*
5" - 6 1/2" projection
FM138400L/
Requires FMH138408/



Let Rowley® do the work for
you with **Custom Solutions**

Save yourself valuable time, our in-house experts will fully assemble your Manual Baton Draw 1 3/8" H-Rail Traverse System(s), custom cut to your exact specification. Ships in 5 business days! See pages 22 - 23 for more information.

accessories



Plain End Cap
FMH138104/



H-Rail Elbow *for Manual
Baton Draw H-Rail only*
FMH138409/



H-Rail Connector / Splice
FMH138407

Manual 1 3/8" H-Rail Traverse

batons



36" Metal Baton
FM312A/
FM312S/

48" Metal Baton
FM314A/
FM314S/

60" Metal Baton
FM316A/
FM316S/

**For PN, order BN.
For VZ & DRB, order MK.*

4 3/4"
Handle

handicap batons



48" Handicap Metal Baton
FM314HA/
FM314HS/

60" Handicap Metal Baton
FM316HA/
FM316HS/



4"
Looped
End

Available Finishes

- Brushed Nickel - BN*
- Antique Brass - AB
- Brushed Bronze - BZ
- Matte Black - MK*

**For PN, order BN.
For VZ & DRB, order MK.*

carriers

1 3/8" Baton Draw H-Rail Traverse Systems work with Pinch Pleat and Ripplefold Roller Carriers.

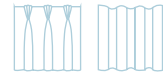

Pinch Pleat Carriers
CP10



Ripplefold Roller Carriers
R2060/ - 60% fullness R2100/ - 100% fullness
R2080/ - 80% fullness R2120/ - 120% fullness



**For more details on Pinch Pleat and Ripplefold carriers & Master Carrier options, please see the price list.*

automation compatible

Manual 1 3/8" H-Rail Traverse

finials & end caps

Antiquities collection

1 3/8" H-Rail Traverse Systems are designed to work with all AriA® 1 3/8" Antiquities Finials on pages 24 - 29.

Plain End Caps FMH138104/ included; order our Saxon End Cap FM138190/ or Avalon End Cap FM138191/ for a more stylized look, or select from 10 finial designs.

Choose from 9 multi-pass finishes on page 25 (Plain and Saxon End Caps also available in Matte Black*).



Plain End Cap*
FMH138104/
shown in PN



Saxon End Cap*
FMH138190/
shown in MK



Avalon End Cap
FMH138191/
shown in AP

introducing our traverse french returns

new

Our *new* curved French Return elbows for H-Rail Traverse allow panels to wrap all the way to the wall for a clean transitional look and can be paired with our French Return Bands to help reduce sidelight.

Available in Matte Black only. Includes H-Rail Return & Splice, Band, End Stops and Pinch Pleat & Ripplefold Carriers.



new

1 3/8" French Return for H-Rail Traverse
3 1/2" projection
FMH138440/MK

*H-Rail Track sold separately.



1 3/8" French Return Band

*Use to secure the drapery, ensuring minimal light gap.



Manual 1 3/8" H-Rail Traverse



Let Rowley® do the work for you with *Custom Solutions*

- Our in-house experts will fully assemble your AriA® Manual Baton Draw 1 3/8" H-Rail Traverse System(s), custom cut to your exact specification.
- Attach with ease - your system arrives, prepared for the seamless addition of your drapery.
- Includes H-Rail Track(s), Brackets, Master Carriers, Carriers, Plain End Caps, labor & packaging.
- Batons and Antiquities Finials or our *new* French Returns for Traverse on [pages 20 - 21](#) sold separately.
- Lengths up to 12' continuous (select finishes) and 24' spliced; minimum length is 18" excluding Finials.
- Pinch Pleat or Ripplefold.
- Ceiling or Wall Mount.
- Lengths over 8' will ship via truck and incur an oversized  fee.



Order using the *Custom Solutions* order form



or online using our

DESIGN your WINDOW ►

feature »



**Custom Solutions are final sale, non-returnable.*

how-to order

1 – CHOOSE YOUR SYSTEM QUANTITY & LENGTH

Let our in-house experts know how many systems to assemble, custom cut to your exact specification. Minimum 18" excluding Finials. Lengths up to 12' continuous (select finishes) and 24' spliced.

2 – CHOOSE YOUR H-RAIL FINISH

Select from 8 finishes on [page 17](#).

3 – CHOOSE YOUR FINIALS & BATONS

Sold separately. For 1 3/8" H-Rail, please select Antiquities Finials on [pages 24 - 29](#). Metal Batons with Handicap option on [page 20](#).

4 – CHOOSE YOUR SYSTEM STYLE

Select from Single, Double or Mixed Double (order Rings on [page 32](#) separately), Ceiling or Wall Mount, with various projection options.

5 – CHOOSE YOUR DRAPERY STYLE, DRAW & MASTER CARRIER

Select from Pinch Pleat or Ripplefold; One-Way Draw Right or Left, Center or Stationary; Hidden or Exposed Baton Master Carriers are standard, or Butt Master Carrier option can be substituted if Ripplefold Drapery Style is selected.

PINCH PLEAT

- Carriers available in White. Please specify number of carriers.



RIPPLEFOLD

- Carriers available in White. 60%, 80%, 100% or 120% fullness available; please specify fullness on order.
- Butt Master Carriers available, allowing some light to filter between draperies on center draw treatments.



our traditional 1 3/8"

Antiquities Collection

The Antiquities Collection evokes a modern interpretation of classic silhouettes embellished with multi-pass finish options in a larger scale 1 3/8" diameter, creating an expanded portfolio of stunning metal hardware window design options.



finishes



Polished Nickel
PN



Antique Pewter
AP



Iron Copper
IC



Antique Brass
AB



Brushed Bronze
BZ



Oil Rubbed Bronze
ORB



Venetian Bronze
VZ



Dark Oil Rubbed Bronze
DRB



Satin Black
SK



Matte Black*
MK



VZ



DRB

*coordinates with VZ & DRB finials

Antiquities

automation compatible

Avalon Ball
FM138100/
shown in DRB

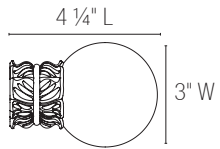

Devon Knob
FM138101/
shown in AB

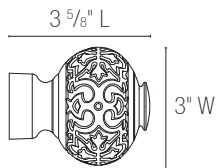
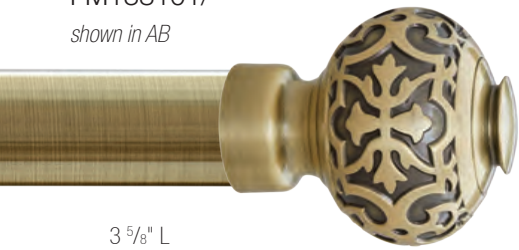

Versailles Square
FM138105/
shown in PN

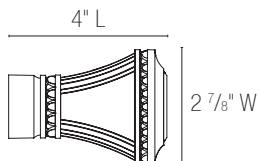
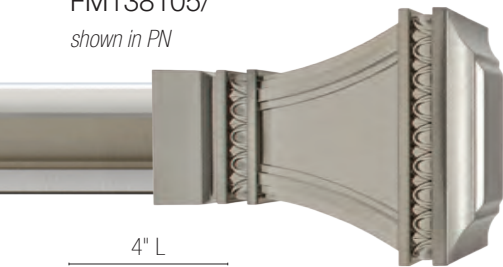

automation compatible

Antiquities



PN

AP

IC

AB

BZ



ORB

VZ

DRB

SK



PN

AP

IC

AB

BZ



ORB

VZ

DRB

SK



PN

AP

IC

AB

BZ



ORB

VZ

DRB

SK

Blakely Urn
FM138102/
shown in IC

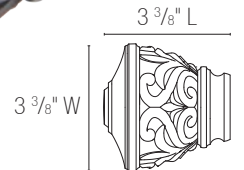

Bellaire Urn
FM138103/
shown in VZ

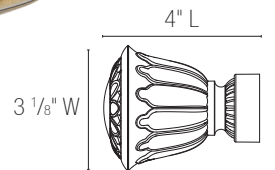
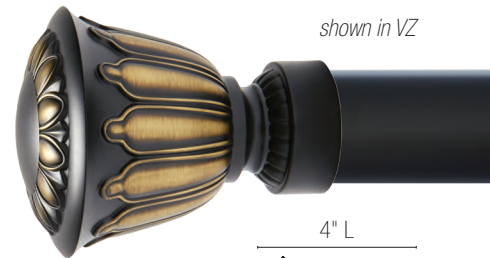

Essex Square
FM138104/
shown in ORB

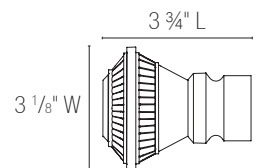
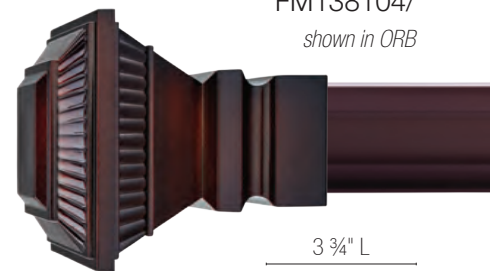

Antiquities

automation compatible

Arabesque Scroll
FM138106/

shown in DRB

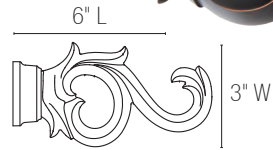

PN



AP



IC



AB



BZ



ORB



VZ



DRB



SK

Paloma Onion
FM138107/

shown in AB

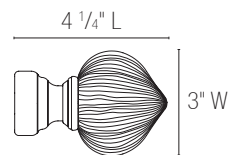

PN



AP



IC



AB



BZ



ORB



VZ



DRB



SK

Saxon End Cap
FM138190/

shown in SK

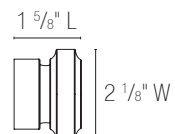

PN



AP



IC



AB



BZ



ORB



VZ



DRB



SK



MK

automation compatible

Antiquities



PN

AP

IC

AB

BZ



ORB

VZ

DRB

SK



PN

AP

IC

AB

BZ



ORB

VZ

DRB

SK



PN

AP

IC

AB

BZ



ORB

VZ

DRB

SK

Sterling Cage
FM138108/
shown in VZ



4 1/4" L

3" W

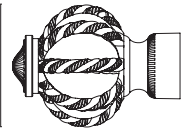

Montclaire Urn
FM138109/
shown in AP



3 3/4" L

3 1/4" W

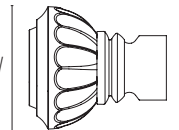

Avalon End Cap
FM138191/
shown in BZ



1 1/2" L

2" W



1 3/8" Accessories

finishes



Polished Nickel
PN



Antique Pewter
AP



Iron Copper
IC



Antique Brass
AB



Brushed Bronze
BZ



Oil Rubbed Bronze
ORB



Satin Black
SK



Matte Black*
MK



VZ



DRB

*coordinates with VZ & DRB finials

poles

Lengths over 8' will ship via truck and incur an oversized fee.

fixed

6' FM138206/

8' FM138208/

12' FM138212/

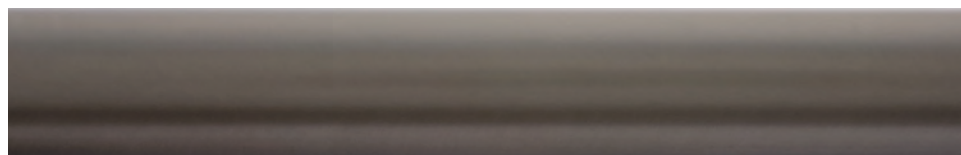

*12' Fixed Poles available in all finishes except BZ and ORB.

*Fixed Poles can be sized to your specification for a \$5 cut fee AriACC.

Easily order your
1 3/8" Stationary
System today!



DESIGN your WINDOW ►



holdbacks



Bellaire Medallion Holdback
FM138900/



Essex Medallion Holdback
FM138901/



Finial Wall Mount Adapter
FM138310/

**Works with Antiquities Finials.*



Holdback Extension
FM138990/
2" increment



batons



Plastic
/A

Steel
/S

36" Metal Baton
FM312A/
FM312S/



4 3/4"
Handle

48" Metal Baton
FM314A/
FM314S/

60" Metal Baton
FM316A/
FM316S/

**For PN, order BN.
For VZ & DRB, order MK.*

handicap batons



Plastic
/A

Steel
/S

48" Handicap Metal Baton
FM314HA/
FM314HS/



4"
Looped
End

60" Handicap Metal Baton
FM316HA/
FM316HS/

Available Finishes

Brushed Nickel - BN*

Antique Brass - AB

Brushed Bronze - BZ

Matte Black - MK*

**For PN, order BN.
For VZ & DRB, order MK.*

1 3/8" Accessories

finishes



Polished Nickel
PN



Antique Pewter
AP



Iron Copper
IC



Antique Brass
AB



Brushed Bronze
BZ

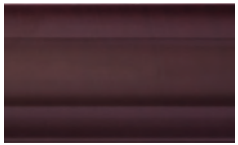

Oil Rubbed Bronze
ORB



Satin Black
SK



Matte Black*
MK



VZ



DRB

*coordinates with VZ & DRB finishes

rings

All rings include plastic inserts for smoother gliding.



Ring with Eyelet 8/pk
FM138200/

*Includes clips



C-Ring with Eyelet 8/pk
FM138202/

*Includes clips



Check out our selection of coordinating #15 Grommets on [pages 62 - 63](#), including our *new* Matte Black finish, available in round and Grom-A-Link™.



new



brackets



Turned Brackets
FM138400/
3 1/2" - 4 1/2" projection

FM138400L/
5" - 6 1/2" projection



Double Turned Bracket
FM138404/
3 1/2" and 6 1/2" projection



Bypass Turned Bracket
FM138408/
3 1/2" - 4 1/2" projection



V-Bracket
FM138410/
4 1/4" - 5 1/2" projection



Inside Mount for Fixed Pole
FM138401/

accessories



Plain End Cap
FMH138104/



Elbow
FM138402/



Splice
FM138403



Finial Set Screws
FMSS/

Available Finishes

Nickel /N

Black /K

our manual baton 1 1/8"

H-Rail Traverse

1 1/8" Baton Draw H-Rail provides the perfect combination of fashion and function, creating a sophisticated solution for both residential and commercial environments. 🏠



finishes



Chrome
CH



Brushed Nickel
BN

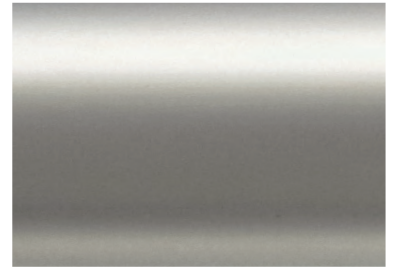

Satin Nickel
SN



Brushed Black Nickel
BBN



Satin Gold
SG

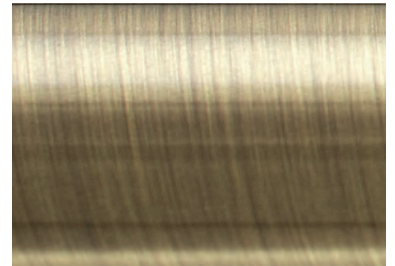

Antique Brass
AB



Oil Rubbed Bronze
ORB

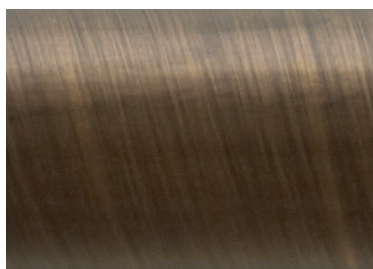

Brushed Bronze
BZ



Matte Black
MK

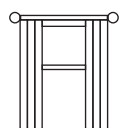

Let Rowley[®] do the work for you with *Custom Solutions*

Use our online [DESIGN your WINDOW ▶](#) feature!



Manual 1 1/8" H-Rail Traverse

system styles

Available lengths: 6', 8' & 12'. 12' lengths are available in all finishes except CH, SG, BZ and ORB. Longer lengths will be spliced up to 24'. Lengths over 8' will ship via truck and incur an oversized  fee.

Baton Draw, Pinch Pleat or Ripplefold. Components sold separately - see price list for options. How-To Order on [page 41](#). Include Plain End Caps & Brackets, and are designed to work with all AriA® 1 1/8" Atelier, Artisan, Abode & Traverse Returns.

single



1 1/8" single wall mount

H-Rail Track (1) with 3 1/2" or 6" Wall Brackets (4) for 6' & 8' kits, (5) for 12' kits and Plain End Caps (2)

- 3 1/2" projection - FMH28400/
- 6" projection - FMH28401/



1 1/8" single ceiling mount

H-Rail Track (1) with Ceiling Brackets (4) for 6' & 8' kits, (5) for 12' kits and Plain End Caps (2)

- 2 3/8" drop - FMH28403/
- 2" Ceiling Bracket Extender available

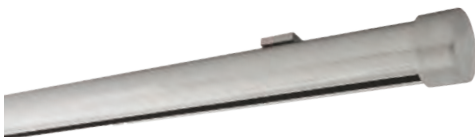

1 1/8" single low profile ceiling mount

H-Rail Track (1) with Low Profile Ceiling Brackets (4) for 6' & 8' kits, (5) for 12' kits and Plain End Caps (2)

- 5/32" drop - FMH28406/

double



1 1/8" double wall mount

H-Rail Tracks (2) with Double Wall Brackets (4) for 6' & 8' kits, (5) for 12' kits and Plain End Caps (4)

- 3" and 7 1/2" projection - FMH28402/



1 1/8" double ceiling mount

H-Rail Tracks (2) with Double Ceiling Brackets (4) for 6' & 8' kits, (5) for 12' kits and Plain End Caps (4)

- 2 5/8" drop, 4 1/2" apart - FMH28404/
- 2" Ceiling Bracket Extender available



1 1/8" mixed double wall mount

H-Rail Track (1) and Fixed Pole (1) with FM400L and Collar Brackets for 6' & 8' kits, (5) for 12' kits and Plain End Caps (4)

- 3 1/2" and 6 1/2" projection - FMH28408/



brackets

Easy to install - attach to H-Rail track with a set screw.



H-Rail Wall Bracket
3 1/2" projection
FMH28400/



H-Rail Wall Bracket
6" projection
FMH28401/



H-Rail Double Wall Bracket
3" and 7 1/2" projection
FMH28402/



H-Rail Ceiling Bracket
2 3/8" drop
FMH28403/



H-Rail Double Ceiling Bracket
2 5/8" drop, 4 1/2" apart
FMH28404/



Ceiling Bracket Extender
2" projection
FMH28405/



H-Rail Low Profile
Ceiling Bracket
5/32" drop
FMH28406/



H-Rail Collar Bracket
FMH28408/
Fits FM400L/



Turned Bracket for Mixed
Double Rod
5" - 6 1/2" projection
FM400L/
Requires FMH28408/



Let Rowley® do the work for you with **Custom Solutions**

Save yourself valuable time, our in-house experts will fully assemble your Manual Baton Draw 1 1/8" H-Rail Traverse System(s), custom cut to your exact specification. Ships in 5 business days! See [pages 40 - 41](#) for more information.

accessories



Plain End Cap
FM104/



H-Rail Elbow
FMH28409/



H-Rail Connector / Splice
FMH28407

Manual 1 1/8" H-Rail Traverse

batons



Plastic /A
Steel /S

36" Metal Baton
FM312A/
FM312S/

48" Metal Baton
FM314A/
FM314S/

60" Metal Baton
FM316A/
FM316S/



4 3/4"
Handle

handicap batons



Plastic /A
Steel /S

48" Handicap Metal Baton
FM314HA/
FM314HS/

60" Handicap Metal Baton
FM316HA/
FM316HS/



4"
Looped
End

Available Finishes

- Brushed Nickel - BN
- Satin Nickel - SN
- Antique Brass - AB
- Brushed Bronze - BZ
- Matte Black - MK

carriers

1 1/8" Baton Draw H-Rail Traverse Systems work with Pinch Pleat and Ripplefold Roller Carriers.

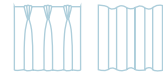

Pinch Pleat Carriers
CP10



Ripplefold Roller Carriers
R2060/ - 60% fullness R2100/ - 100% fullness
R2080/ - 80% fullness R2120/ - 120% fullness



*For more details on Pinch Pleat and Ripplefold carriers & Master Carrier options, please see the price list.

finials & end caps

1 1/8" H-Rail Traverse Systems are designed to work with all AriA® 1 1/8" Atelier, Artisan and Abode Finials on pages 42 - 55.

Plain End Caps FM104/ included; order our Beveled Disc End Cap FM605/ or Beveled Square End Cap FM604/ for a more stylized look, or select from over 25 finial designs.



Plain End Cap
FM104/
shown in BN



Beveled Disc End Cap
FM605/
shown in MK



Beveled Square End Cap
FM604/
shown in SG

introducing our traverse french returns



Our *new* curved French Return elbows for H-Rail Traverse allow panels to wrap all the way to the wall for a clean transitional look and can be paired with our French Return Bands to help reduce sidelight.

Available in Matte Black only. Includes H-Rail Return & Splice, Band, End Stops and Pinch Pleat & Ripplefold Carriers.



1 1/8" French Return for H-Rail Traverse
3 1/2" projection
FMH118440/MK

**H-Rail Track sold separately.*



1 1/8" French Return Band

**Use to secure the drapery, ensuring minimal light gap.*



Manual 1 1/8" H-Rail Traverse



Let Rowley[®] do the work for you with *Custom Solutions*

- Our in-house experts will fully assemble your AriA[®] Manual Baton Draw 1 1/8" H-Rail Traverse System(s), custom cut to your exact specification.
- Attach with ease - your system arrives, prepared for the seamless addition of your drapery.
- Includes H-Rail Track(s), Brackets, Master Carriers, Carriers, Plain End Caps, labor & packaging.
- Batons and Atelier, Artisan, Abode Finials or our *new* French Returns for Traverse on pages 38 - 39 sold separately.
- Lengths up to 12' continuous (select finishes) and 24' spliced; minimum length is 18" excluding Finials.
- Pinch Pleat or Ripplefold.
- Ceiling or Wall Mount.
- Lengths over 8' will ship via truck and incur an oversized  fee.
- See price list for pricing.



Order using the *Custom Solutions* order form



or online using our

DESIGN your WINDOW ►

feature »



**Custom Solutions are final sale, non-returnable.*

how-to order

1 – CHOOSE YOUR SYSTEM QUANTITY & LENGTH

Let our in-house experts know how many systems to assemble, custom cut to your exact specification. Minimum 18" excluding Finials. Lengths up to 12' continuous (select finishes) and 24' spliced.

2 – CHOOSE YOUR H-RAIL FINISH

Select from 9 finishes on [page 35](#).

3 – CHOOSE YOUR FINIALS & BATONS

Sold separately. For 1 1/8" H-Rail, please select Atelier, Artisan or Abode Finials on [pages 42 - 55](#). Metal Batons with Handicap option on [page 38](#).

4 – CHOOSE YOUR SYSTEM STYLE

Select from Single, Double or Mixed Double (order Rings on [page 58](#) separately), Ceiling or Wall Mount, with various projection options.

5 – CHOOSE YOUR DRAPERY STYLE, DRAW & MASTER CARRIER

Select from Pinch Pleat or Ripplefold; One-Way Draw Right or Left, Center or Stationary; Hidden or Exposed Baton Master Carriers are standard, or Butt Master Carrier option can be substituted if Ripplefold Drapery Style is selected.

PINCH PLEAT

- Carriers available in White. Please specify number of carriers.



RIPPLEFOLD

- Carriers available in White. 60%, 80%, 100% or 120% fullness available; please specify fullness on order.
- Butt Master Carriers available, allowing some light to filter between draperies on center draw treatments.



our modern 1 1/8"

Atelier Collection

The 1 1/8" Atelier Collection features modern finial designs in contemporary finishes that can be mixed and matched to create unique drapery hardware designs.





CH/CH



SN/CH



SG/SG



BBN/CH



MK/BBN



MK/SG



Tapered Ball
FM600/
shown in MK/SG

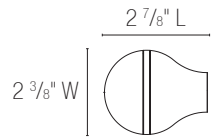

CH



SN



SG



BZ



BBN



MK

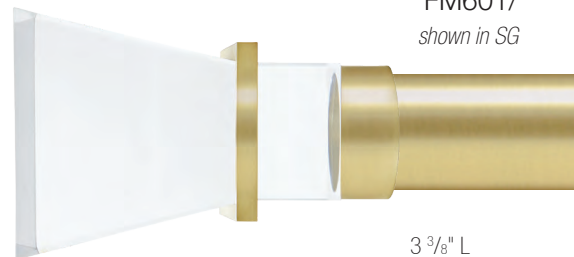

Acrylic Flute
FM601/
shown in SG

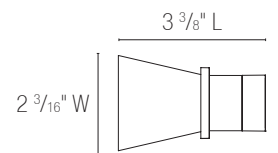

Atelier

Faceted Square End Cap

FM603/

shown in SN

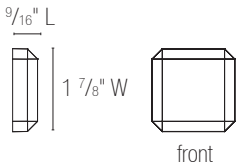

CH



SN



SG



BZ



BBN



MK

Beveled Square End Cap

FM604/

shown in BZ

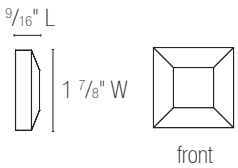

CH



SN



SG



BZ



BBN



MK

Beveled Disc End Cap

FM605/

shown in SG

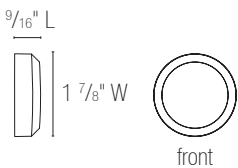

CH



SN



SG



BZ



BBN



MK

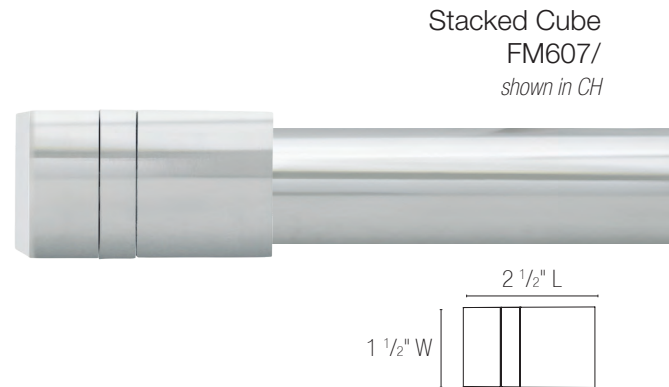
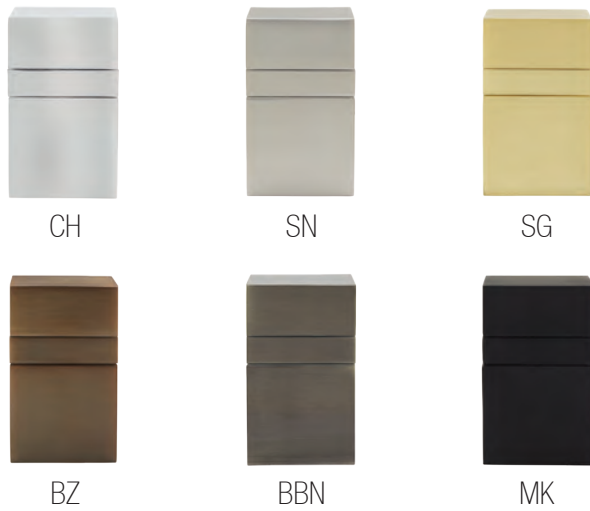
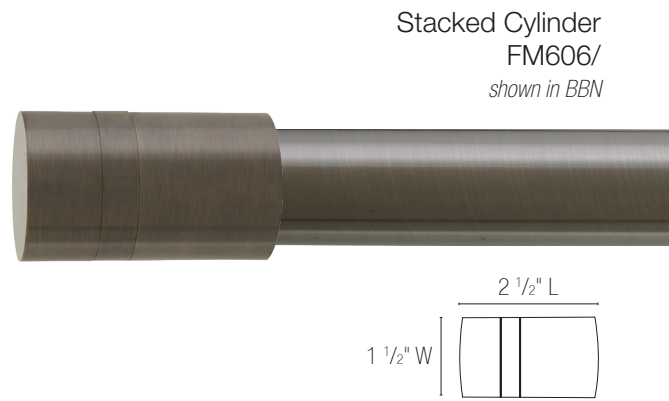

mix & match shagreen finials

- step 1* Select a 1 1/8" Cylinder or Cube Metal Base.
- step 2* Pick a coordinating metal finish for the middle band.
- step 3* Choose a Metal Cap.

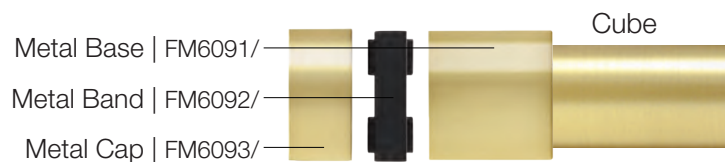
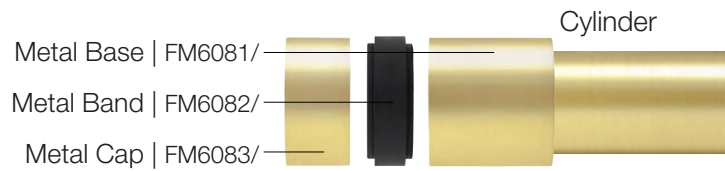
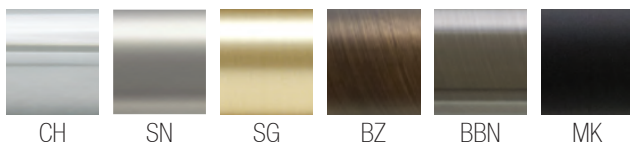

Atelier

mix & match shagreen finials

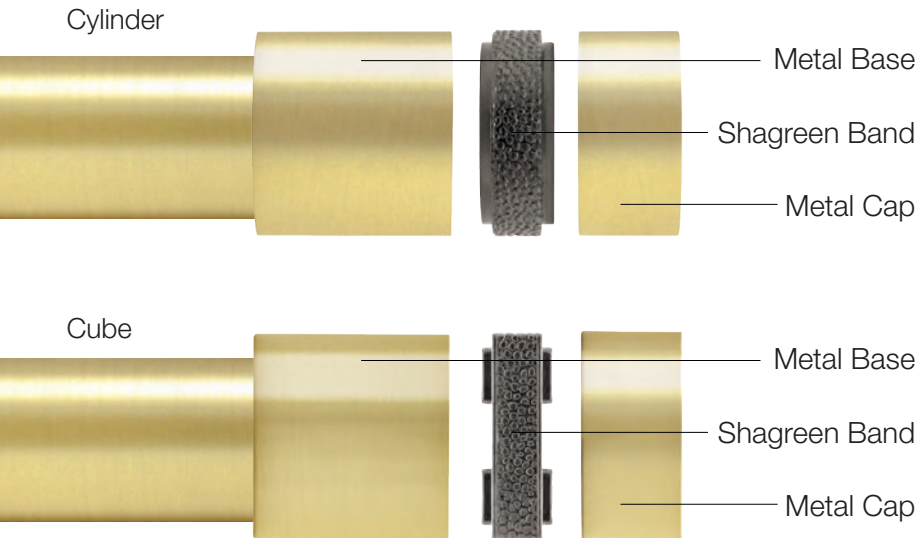

metal finishes

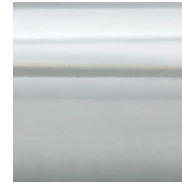

Chrome
CH



Satin Nickel
SN



Satin Gold
SG

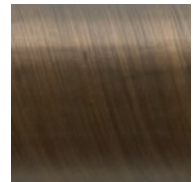

Brushed Bronze
BZ

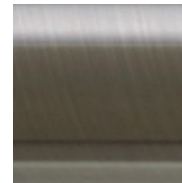

Brushed Black
Nickel
BBN

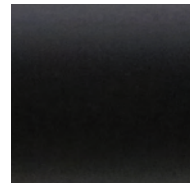

Matte Black
MK

step 1

Select a 1 1/8" Metal Base. Pick from two styles: Cylinder or Cube.



Cylinder Metal Base
FM6081/



Cube Metal Base
FM6091/

step 2

Pick a coordinating shagreen finish for the middle band*.



Cylinder Shagreen Band
FM6082/



Cube Shagreen Band
FM6092/

*shagreen finishes**



Chrome
T/CH



Satin Gold
T/SG

step 3

Choose a Metal Cap.



Cylinder Metal Cap
FM6083/



Cube Metal Cap
FM6093/

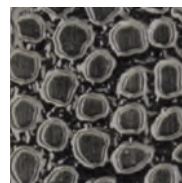

Brushed Black
Nickel
T/BBN

*Band options only.



*mix & match
cylinder finial*

shown in Chrome with
Satin Gold Shagreen Band

our eclectic 1 1/8"
Artisan Collection

With this 1 1/8" eclectic collection, we are focused on the art of detail. Our philosophy is to incorporate innovative design techniques and diverse materials into a stylish drapery hardware offering.





BN/MK



SN



BBN



AB



ORB



BZ

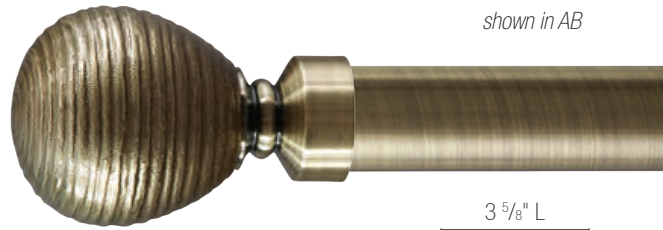

Contour Striated Ball
FM500/
shown in AB

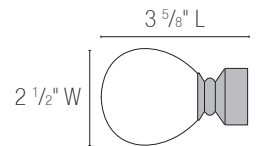

NI/SN



PT/MK



AM/ORB



AM/MK



BR/BZ



BR/MK



Rustic Forged Ball
FM501/
shown in PT/MK

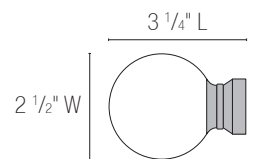

Artisan

Craftsman Wood Square
FM505/

shown in WA/MK

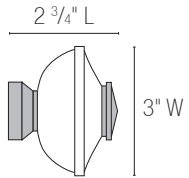

ES/BN



ES/MK



ES/ORB



MA/SN



WA/MK



PE/SN

Vintage Stone Knob
FM506/

shown in BN

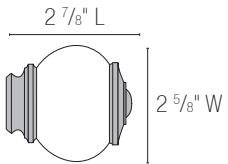
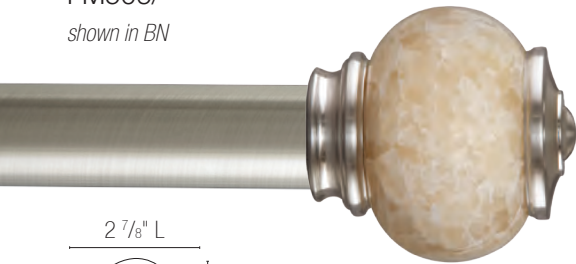

BN



SN



AB



BZ



MK

Fluted Stone Trumpet
FM507/

shown in BZ

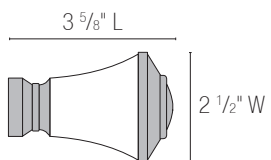

BN



BBN



AB



BZ



MK



BN



SN



AB



ORB



BZ



MK

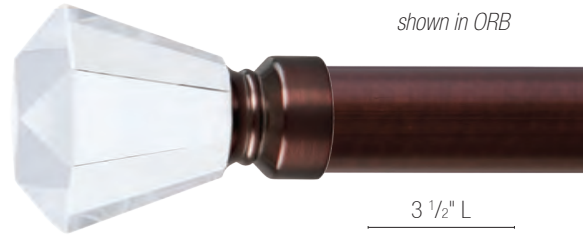

Deco Glass Trumpet
FM502/
shown in ORB

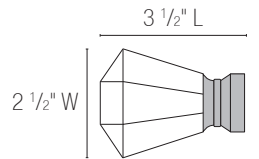

BN



BBN



AB



ORB



BZ



MK

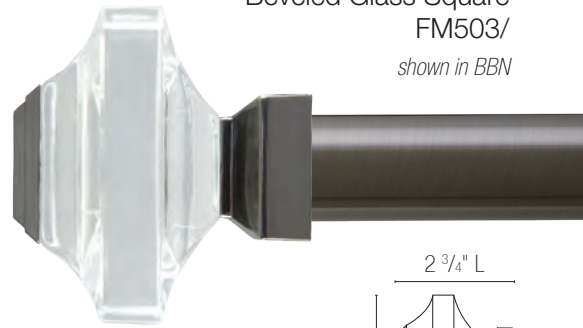

Beveled Glass Square
FM503/
shown in BBN

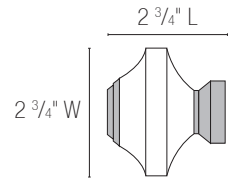

ES/BN



MA/BN



MA/MK



WA/SN



PE/SN



PE/MK



Carved Facet
Ball FM504/
shown in MA/BN

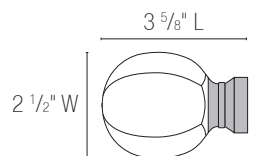

our transitional 1 1/8"

Abode Collection

This 1 1/8" transitional collection is elemental and essential. Each finial has been designed to transcend time while combining the elements of quality, beauty and value.



Abode



BN

SN

BBN

SG

AB



ORB

BZ

MK



BN

SN

BBN

SG

AB



ORB

BZ

MK



BN

SN

BBN

SG

AB



ORB

BZ

MK



Ball
FM100/
shown in BN

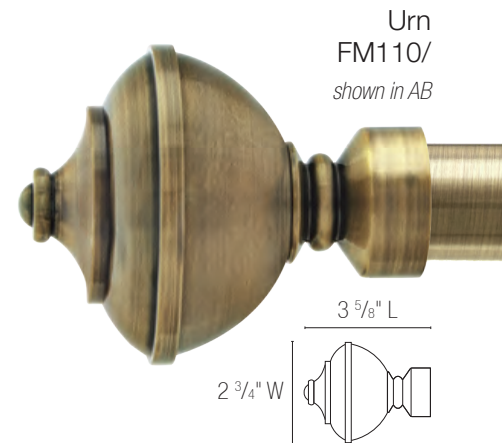
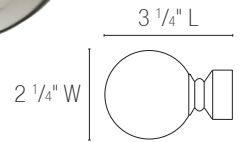

Urn
FM110/
shown in AB

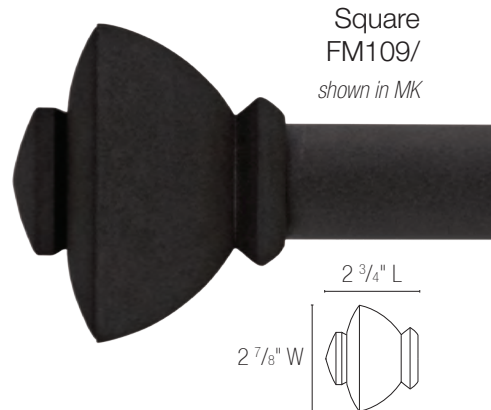
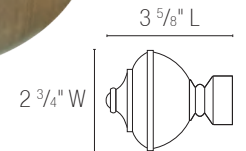

Square
FM109/
shown in MK

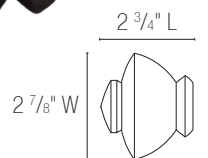

Abode

Stacked Square
FM119/
shown in ORB

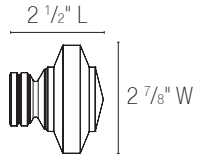

BN SN BBN SG AB



ORB BZ MK

Egg
FM111/
shown in MK

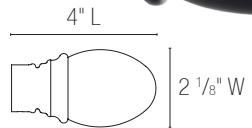

BN SN BBN SG AB



ORB BZ MK

Trumpet
FM112/
shown in SG

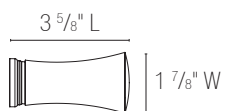

BN SN BBN SG AB



ORB BZ MK

Abode

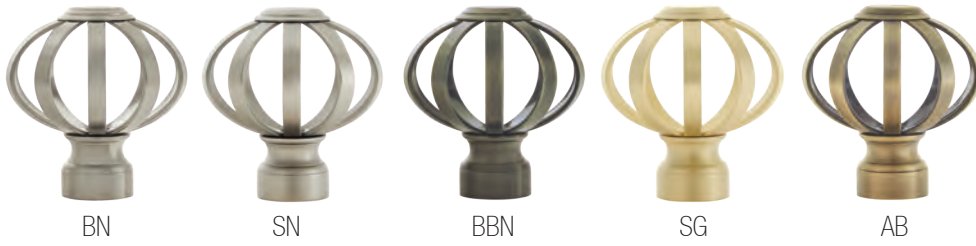

BN

SN

BBN

SG

AB



ORB

BZ

MK

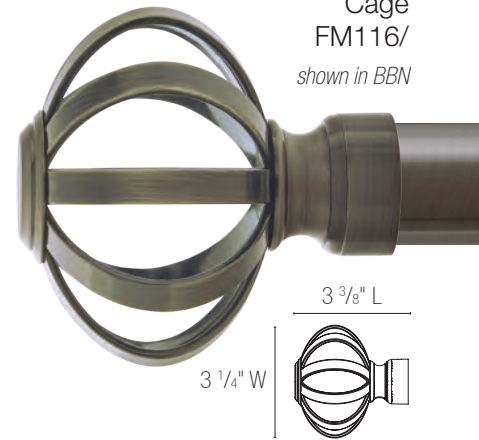

Cage
FM116/
shown in BBN



BN

SN

BBN

SG

AB



Blown Glass Ball
FM107/
shown in BZ



ORB

BZ

MK



BN

SN

BBN

SG

AB



Plain End Cap
FM104/
shown in SN



ORB

BZ

MK



3/4" L

1 1/4" W

1 1/8" Accessories

finishes

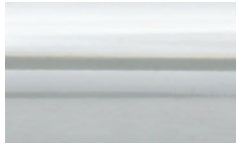

Chrome
CH



Brushed Nickel
BN

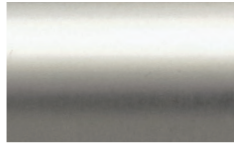

Satin Nickel
SN



Brushed Black Nickel
BBN



Satin Gold
SG

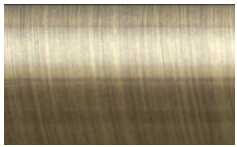

Antique Brass
AB



Oil Rubbed Bronze
ORB

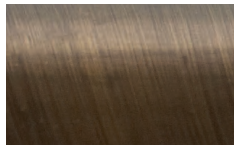

Brushed Bronze
BZ

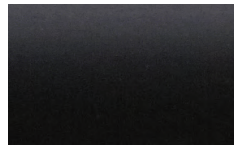

Matte Black
MK

poles

Lengths over 8' will ship via truck and incur an oversized  fee.

fixed

4'	FM284/
6'	FM286/
8'	FM288/
12'	FM2812/



*12' Fixed Poles are available in all finishes except BZ and ORB.
*Fixed Poles can be sized to your specification for \$5 cut fee AriACC.

telescoping

28" - 48"	FMTR281/
48" - 84"	FMTR282/
66" - 120"	FMTR283/



*Telescoping Poles only work with Artisan and Abode Finials.
*Available in all finishes except CH.



holdbacks



Ball Holdback
FM300/



Cylinder Holdback
FM302/



Finial Wall Mount Adapter
FM310/

**Works with Artisan and Abode Finials.*

batons



Plastic
/A



Steel
/S

36" Metal Baton
FM312A/
FM312S/



4 3/4"
Handle

48" Metal Baton
FM314A/
FM314S/

60" Metal Baton
FM316A/
FM316S/

handicap batons



Plastic
/A



Steel
/S

48" Handicap Metal Baton
FM314HA/
FM314HS/



4"
Looped
End

60" Handicap Metal Baton
FM316HA/
FM316HS/

Available Finishes

- Brushed Nickel - BN
- Satin Nickel - SN
- Antique Brass - AB
- Brushed Bronze - BZ
- Matte Black - MK

1 1/8" Accessories

finishes

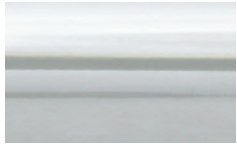

Chrome
CH



Brushed Nickel
BN

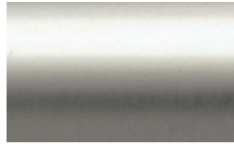

Satin Nickel
SN



Brushed Black Nickel
BBN



Satin Gold
SG

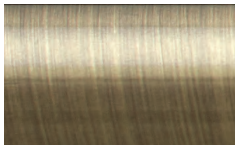

Antique Brass
AB



Oil Rubbed Bronze
ORB



Brushed Bronze
BZ

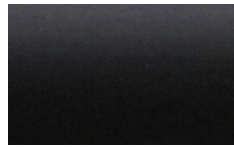

Matte Black
MK

rings

All rings include plastic inserts for smoother gliding.



Ring with Eyelet 8/pk
FM200/
**Includes clips*



C-Ring with Eyelet 8/pk
FM202/
**Includes clips*



Square Ring with Eyelet 8/pk
FM204/
**Includes clips*

coordinates with our modern
Atelier Collection
pages 42 - 47

Available Finishes



CH SN BBN SG BZ MK

Check out our selection of coordinating #12 Grommets on pages 62 - 63, including our *new* Matte Black finish, available in round and Grom-A-Link™.



brackets



Turned Brackets
FM400/ works with French Returns
3 1/2" - 4 1/2" projection

FM400L/ works with French Returns
5" - 6 1/2" projection



Double Turned Bracket
FM404/
3 1/2" and 6 1/2" projection



Bypass Turned Bracket
works with French Returns
FM408/
3 1/2" - 4 1/2" projection



Orbital Brackets
FM405/ - 2 1/2" projection
FM406/ - 3 1/2" projection
FM407/ - 6" projection works with
French Returns

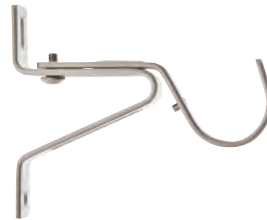

V-Bracket works with French Returns
FM410/
3 1/4" - 4" projection



Inside Mount for Fixed Pole
FM401/

accessories



Plain End Cap
FM104/



Elbow
FM402/



Finial Set Screws
FMSS/



Plastic Plug
FM118PL

*fits Atelier Finials



Splice works with French Returns
FM403

Available Finishes

Nickel /N

Black /K

our sleek 1 1/8"

French Return Collection

Our curved 1 1/8" French Return elbows with stylish mounting plates allow panels to wrap all the way to the wall for a clean transitional look and can be paired with our French Return Bands to help reduce sidelight. For use on Stationary Poles only; see pages 13, 21 & 39 for our *new* Returns for H-Rail Traverse.



French Returns



BN



ORB



BZ



MK



1 1/8" French Return
with Faceted Square
Mounting Plate
4" and 6" projection
FM118440/
**Pole sold separately.*
shown in MK



BN



ORB



BZ



MK



1 1/8" French Return
with Beveled Round
Mounting Plate
4" and 6" projection
FM118441/
**Pole sold separately.*
shown in MK

**For use on Stationary Poles only; see pages 13, 21 & 39 for our new Returns for H-Rail Traverse.*



French Return bands

Bands can be used to secure the drapery ensuring minimal light gap or to cover the seams of the pole.



BN



ORB



BZ



MK

1 1/8" French Return Band
FM118449/



Pair with our 1 1/8"
coordinating rings
& support brackets

page 59

our coordinating
Grommets

Perfect for stylish, modern drapery treatments. Grommets coordinate with 1 1/8" & 1 3/8" diameter poles - use #12 size for 1 1/8" or #15 for 1 3/8". See price list for coordinating finishes, including our *new* Matte Black option.





grommets



new

grom-a-link™

Allows a Baton to be added to the first Grommet if desired, and when combined with Bead Chain can serve as a Pleat Control System, creating a functional traversing grommet panel. See price list for installation details.



new

to place an order

Phone 1-800-343-4542 or 704-866-0650
1-866-985-3423 (Motorized Systems)

AriAMetalHardware.com

230 Meek Road
Gastonia, NC 28056

Offices are open
Monday - Friday
8:00AM - 6:00PM ET

