

COCO
Deco

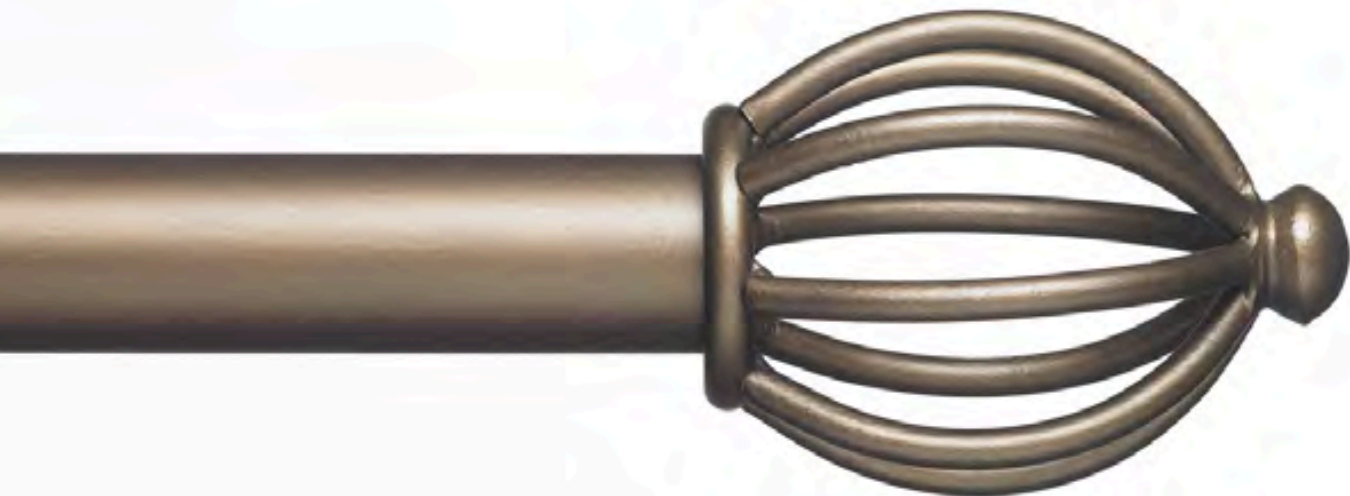
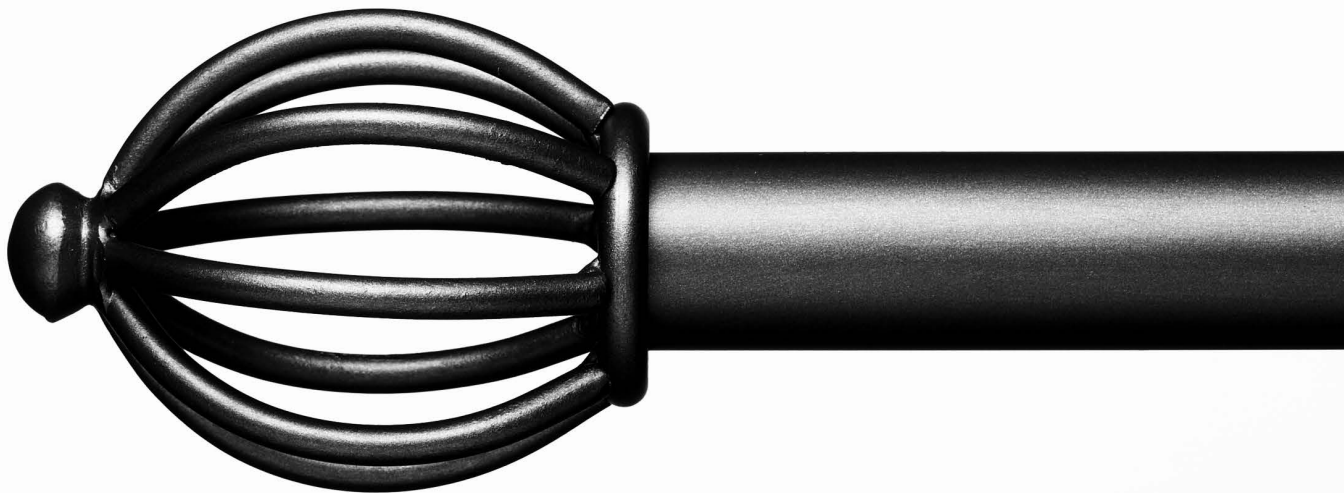
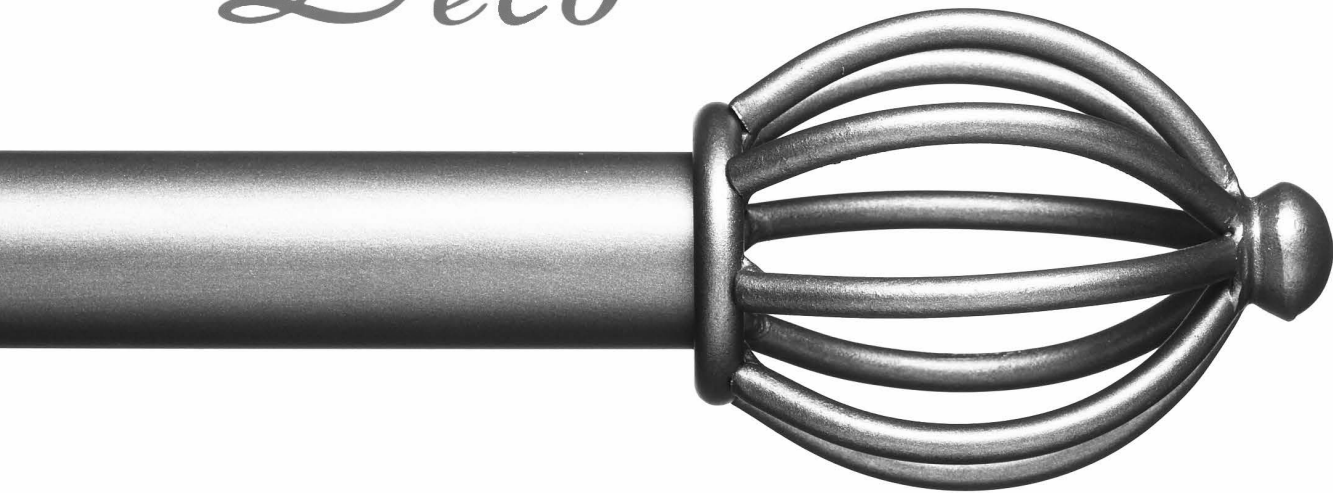

COCO
Deco

HEIRLOOM QUALITY
HAND CRAFTED
CUSTOM DRAPERY HARDWARE
AUTHENTIC MATERIALS
FORGED IRON
AMERICAN GROWN HARDWOOD

TABLE OF CONTENTS

NEXT GENERATION IRON _____ 4-11

ESTATE IRON _____ 12-17

CUSTOM IRON _____ 18-23

FRENCH RETURN _____ 24-27

CONTEMPORARY METAL _____ 28-31

SEDONA _____ 32-35

PLANTATION WOOD _____ 36-39

STRUCTURE _____ 40-43

LOFT MOTORIZATION _____ 44-47

PRESENTATION SAMPLES _____ 48-52

MEASURING GUIDE _____ 53

ORDERING GUIDES _____ 54-55



NEXT GENERATION IRON

New Designs & Finishes in Ring, Traverse and Motorized Configurations



RINGS



TRAVERSE



MOTORIZED

MOTORIZED



Rod Sets are custom made, assembled & shipped ready to install

- 1-1/2" DIAMETER
- SINGLE & DOUBLE ROD SETS
- CENTER & ONE-WAY DRAW
- AUTOMATIC LIMIT POSITION
- SOFT OPENING & CLOSING
- WHISPER QUIET
- ROD SETS UP TO 188"
- OPTIONAL Wi-Fi MODULE FOR CONTROL WITH ALEXA, SIRI, GOOGLE ASSISTANT & SMART PHONE



ONE-WAY DRAW



MOTORS & REMOTES
FACTORY PAIRED

MOTORS

110v Motor with 12' cord or 12v Lithium battery powered Motor



DOUBLE ROD SET

Wi-Fi

Optional Wi-Fi Module easily connects to bottom of motor



"Alexa, open the curtains."

REMOTES



Dual-Channel



Dual-Channel
Wireless Wall
Switch

15-Channel Remote & 15-Channel Wireless Wall Switch available

RUSTICA
14

BRONZE
31

NICKEL
16

BLACK
03

SMOKE
01

TRAVERSE



Two-Segment Rod Sets have a center splice with low profile screws

- 1-1/2" DIAMETER
- SINGLE & DOUBLE ROD SETS
- CENTER & ONE-WAY DRAW
- STANDARD & RIPPLEFOLD CARRIERS
- CORNER & BAY SETS
- RODS UP TO 188"



DOUBLE ROD SET



ADJUSTABLE ELBOW

RINGS



- SINGLE & DOUBLE ROD SETS
- CORNER & BAY SETS
- MAGNETIC BRACKETS
- LONG LENGTHS AVAILABLE



ADJUSTABLE ELBOW

BAYS & CORNERS

We can calculate your lengths for all your bay & corner windows

PLEASE SEE THE MEASURING GUIDE



DOUBLE ROD SET

RINGS



2 inch

2 inch C-Ring

NEXT GENERATION IRON



KNOB



BALL



END CAP



CYLINDER



BOW TIE



SIMPLE END

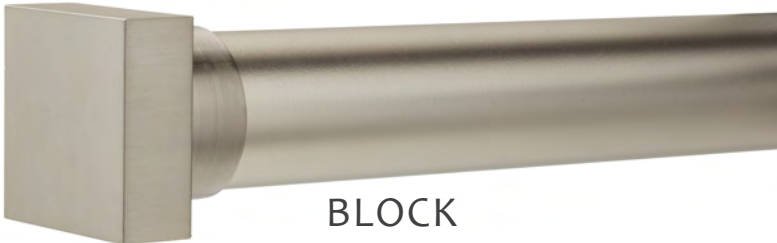

BLOCK



CLEAR SQUARE



CONTEMPO



RIBBON



CLEAR CYLINDER

BRACKETS

STANDARD

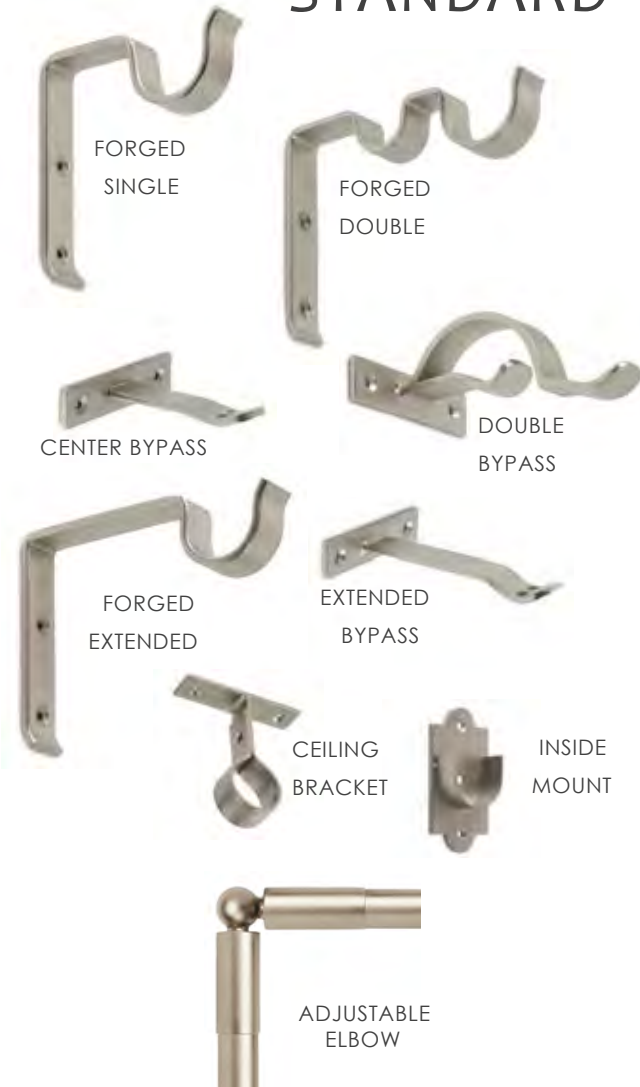

TRAVERSE & MOTORIZED

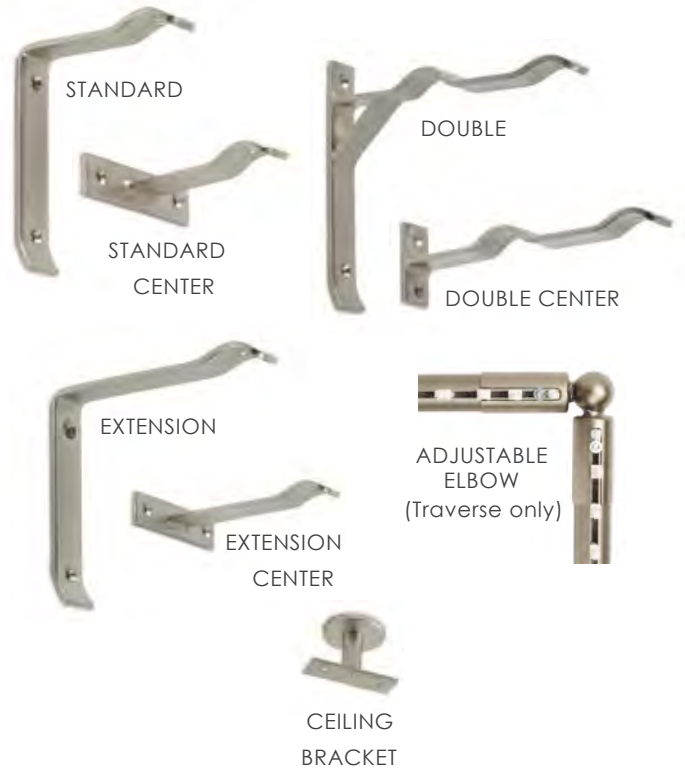

TIE BACKS



NEXT GENERATION IRON MOTORIZED 1.5" DIAMETER ROD SETS

- **Single Rod Set**
- **Double Rod Set**
- Sets include: Rod, motor, finials and mounting hardware.
- Single and Double rod sets come with standard brackets included. Extension brackets can be substituted for no additional charge.
- Double rod sets feature Simple End Cap finials on the 1-1/2" back rod.
- Rod widths greater than 48", include center support brackets.

SEE PRICE LIST FOR PRICES AND ORDERING INFORMATION

FINIALS

DESCRIPTION	DIMENSIONS
Knob	3/4" W x 2-1/2" H
Ribbon	1-3/4" W x 2-1/4" H
Bow Tie	2-3/4" W x 3" H
Block	7/8" W x 2" H
Cylinder	2-3/4" W x 2" H
Ball	2-1/2" W x 2-3/8" H
End Cap	1/2" W x 2-3/4" H
Clear Square	1-1/4" W x 2-3/4" H
Contempo	1-3/8" W x 2" H
Simple End Cap	3/4" W x 2" H
Clear Cylinder	2-1/8" W x 2" H

SPECIFICATIONS & DIMENSIONS

REMOTES

DESCRIPTION

- Dual-Channel Handheld Remote (control up to 2 motors)
- 15-Channel Remote (control up to 30 motors)
- Dual-Channel Wireless Wall Switch (control up to 2 motors)
- 15-Channel Wireless Wall Switch (control up to 15 motors)

MOTORS

DESCRIPTION

DESCRIPTION	Max Curtain Wt. (lb.)	Rated Torque (lb-in.)	Open/Close Speed (in./sec)	Rated Current (A)	Weight (lb.)	Cord Length (ft.)	Average Battery Charge (mos.)
110v AC Plug-in Motor	100	10.6	5.5	0.16	3.9	12	N/A
12v Rechargeable Lithium Battery Motor	66	10.6	5.5	0.16	3.9	N/A	6

- All remotes and switches come paired to the motor.
- Control multiple motors with one remote.
- 3v Battery included with remotes and switches

Wi-Fi MODULE



- amazon alexa
- Google Assistant
- 'Hey Siri'

- Wi-Fi Module easily connects to the bottom of the plug-in motor.
- Use your smart phone to control motor with APP available in the APP Store and Google Play.
- WiFi Module connects with Amazon Alexa, Google Assistant and Siri.

MASTER CARRIERS

DESCRIPTION

- Standard Motorized Master (Center Draw)
- Extension Arm Master (One-way Draw)

BRACKETS

DESCRIPTION

DIMENSIONS

Standard	1" W x 5-1/2" H x 4-1/4" D (3-1/2" projection)
Extension	1" W x 5-1/2" H x 5-3/4" D (5" projection)
Double	1" W x 6-1/2" H x 7-3/8" D (3" & 6-1/2" projection)
Standard Center	4" W x 1" H x 4-1/4" D (3-1/2" projection)
Extension Center	4" W x 1" H x 5-3/4" D (5" projection)
Double Center	1" W x 2" H x 7-3/8" D (3" & 6-1/2" projection)
Ceiling	2" W x 1-1/2"- 12" H x 2" D (Custom made)

- Projection is measured from the center of the bracket cup to the back plate of the bracket. D is the distance; it is measured from the front of the bracket to the back plate of the bracket. W is the horizontal length of the bracket while the H is the vertical length of the bracket back plate.



ESTATE IRON

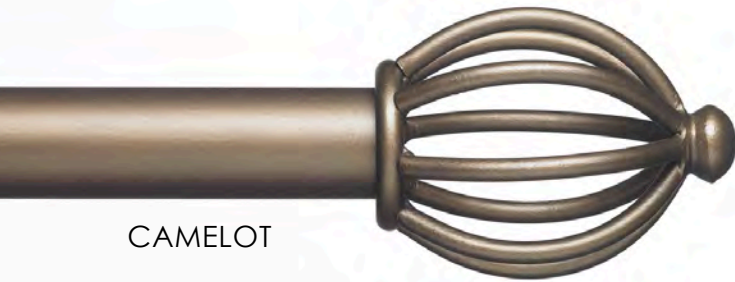

CAMELOT



FLAME



DOUBLE ACANTHUS

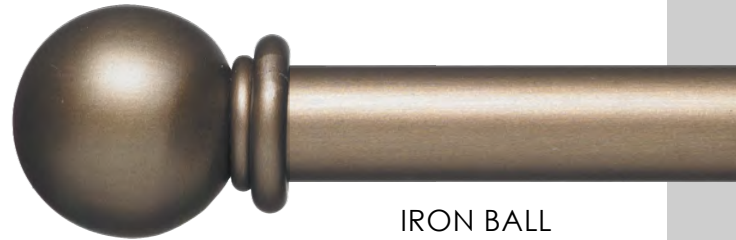

IRON BALL

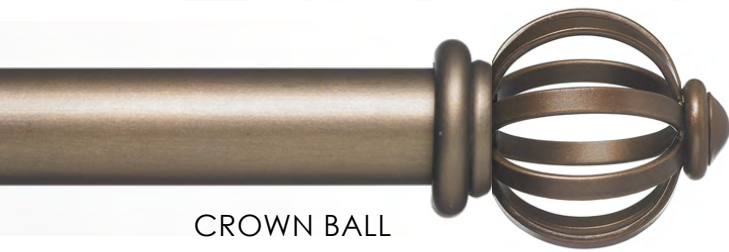

CROWN BALL



TERRAZZO



PAPYRUS

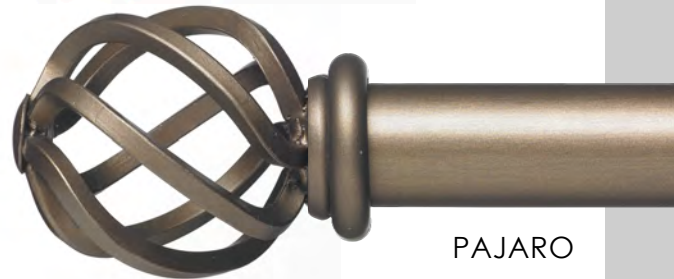

PAJARO



DOUBLE SCROLL LEAF



END CAP



SCROLL

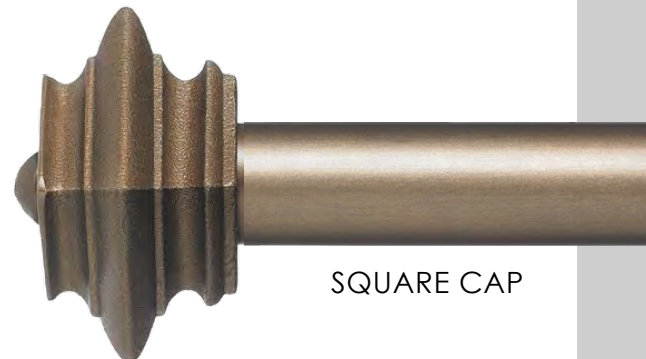

SQUARE CAP

BRACKETS



SINGLE

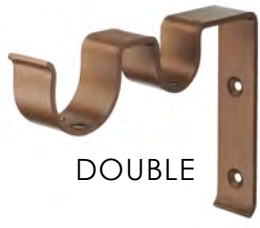

DOUBLE

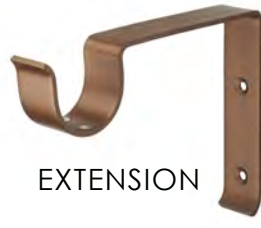

EXTENSION



C-RING CENTER



C-RING DOUBLE CENTER



C-RING EXTENDED CENTER



INSIDE MOUNT



CEILING MOUNT



ELBOW

TIE BACKS



FLAME



ACANTHUS LEAF



SCROLL



ORBED



IRON SCROLL



END CAP-POST STYLE



END CAP-U-STYLE

BRONZE
31

- 1-1/2" DIAMETER
- SINGLE AND DOUBLE ROD SETS
- FORGED IRON HARDWARE
- CUT TO SIZE
- BAY & CORNER WINDOWS
- INSIDE MOUNT

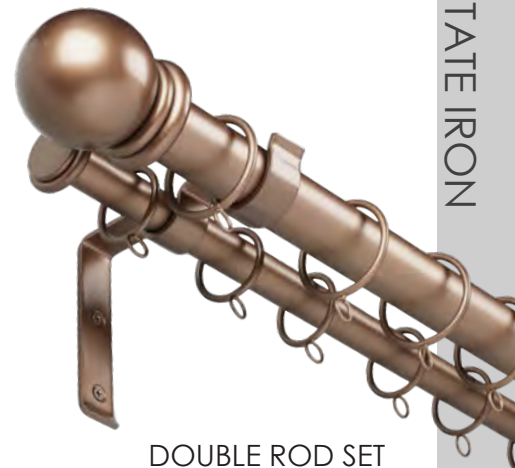

DOUBLE ROD SET

RUSTICA
14

ACCESSORIES

PEWTER
12

RINGS



2-INCH OR 2.5 INCH



C-RINGS



2-INCH ONLY

BLACK
03

BAYS & CORNERS

We can calculate your rod lengths for all your bay and corner windows!

PLEASE SEE THE MEASURING GUIDE



ELBOW CONNECTOR

GOLD
37

OUTDOOR READY FINISH OPTION

Decorate your deck, cabana or outdoor space! Outdoor finish option is available for a 25% up-charge, which includes a full 5-year replacement warranty. Sets must be installed under an eave or overhang, avoiding direct exposure to the elements. Regular wipe down is required. Not recommended for high humidity or beach environments. AVAILABLE ONLY IN OIL RUBBED BRONZE, RUSTICA AND BLACK.

ESTATE IRON

1.5" DIAMETER ROD SETS

SEE PRICE LIST FOR PRICES AND ORDERING INFORMATION

- **Single Rod Set** SET INCLUDES:
- **Double Rod Set** Rod, finials, brackets and mounting hardware.
- **Corner Window Rod Set**
- **Bay Window Rod Set**
- **Inside Mount Rod Set**

- Single, Double, Corner and Bay sets come with standard brackets included. Extension brackets can be substituted for no additional charge.
- Double rod sets feature end cap finials on the 1" back rod.
- No finials on inside mount rod sets.
- Rod widths greater than 72", include center support brackets.

Rod Sets up to 94" are made as one piece. Rod Sets over 94" and up to 188" will come in two pieces. Rod Sets over 188" and up to 282" will come in 3 pieces. Rod segments made in one piece over 94" carry a substantial shipping surcharge and additional production surcharge.

SPECIFICATIONS & DIMENSIONS

FINIALS

DESCRIPTION	DIMENSIONS	LENGTH ADDED TO THE END OF THE ROD
Grande Pajaro	5-1/2" W x 4-1/4" H	5-1/4"
Grande Double Scroll Leaf	6" W x 8" H	5-1/2"
Grande Square Cap	2-3/4" W x 3" H	2-1/2"
Crown Ball	4" W x 3-1/4" H	3-3/4"
Grande Scroll	7-1/4" W x 3-1/2" H	7"
Grande Flame	8-1/2" W x 4" H	8"
Grande Double Acanthus	7-1/2" W x 4" H	7-1/4"
Grande Iron Ball	3-1/2" W x 3" H	3-1/4"
Grande Camelot	5-1/2" W x 3-1/2" H	5-1/4"
Grande Terrazzo	6-3/4" W x 2-3/4" H	6-1/2"
Grande Papyrus	5-1/4" W x 3-1/4" H	5"
Grande End Cap	7/8" W x 2-1/2" H	1/8"

RINGS

DESCRIPTION	INSIDE DIAMETER
Rings - eyelet (10 pack)	2"
C-Rings - eyelet (10 pack)	2"
Rings - eyelet (10 pack)	2-1/2"

1103 rings on front rod and 1102 rings on back rod for double rod sets.

BRACKETS

DESCRIPTION	DIMENSIONS
Forged Single	1" W x 5" H x 4-5/8" D (3-1/2" projection)
Forged Double(1)	1" W x 5" H x 6-1/8" D (2-1/2" & 5" projection)
Forged Extended	1" W x 5" H x 6-1/8" D (5" projection)
C-Ring Center Bypass	4" W x 1-1/8" H x 4-5/8" D (3-1/2" projection)
C-Ring Double Center (1)	4" W x 1-1/8" H x 6-1/8" D (2-1/2" & 5" projection)
C-Ring Extended Center	4" W x 1-1/8" H x 6-1/8" D (5" projection)
Inside Mount	2" W x 4-1/2" H x 1" D (1/8" projection)
Ceiling Mount	1" W x 4-1/2" H x 4" D (3-1/2" projection)

(1) Front cup holds a 1-1/2" rod and back cup holds a 1" rod

* Projection is measured from the center of the bracket cup to the back plate of the bracket. D is the distance; it is measured from the front of the bracket to the back plate of the bracket. W is the horizontal length of the bracket while the H is the vertical length of the bracket back plate.

TIEBACKS

DESCRIPTION	DIMENSIONS
Flame (U style)	9" face x 2-1/4" width x 6-1/2" projection
Acanthus Leaf (U style)	7" face x 4" width x 5-1/4" projection
Scroll (U style) - left	7" face x 4" width x 4-3/4" projection
Scroll (U style) - right	7" face x 4" width x 4-3/4" projection
Orbed (U style)	6" face x 1-1/2" width x 4-1/2" projection
Iron Scroll (Post style)	7-1/2" face x 3-1/4" x 4-3/4" projection
End Cap (Post style)	2" width x 4-3/8" projection
End Cap (U style)	6" face x 1-7/8" width x 5-3/4" projection





CUSTOM IRON

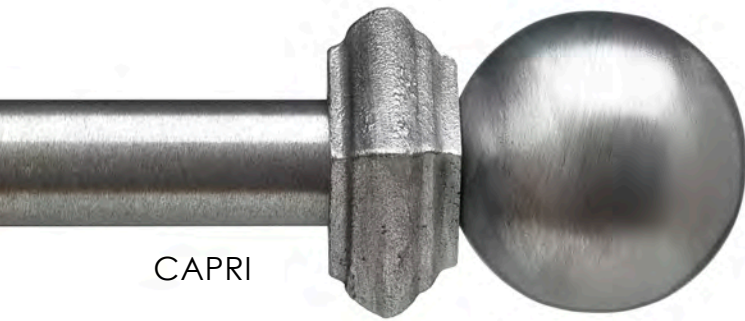

CAPRI



TORCHE



END CAP



ACANTHUS LEAF



TERRAZZO



FLEUR



IRON BALL



ACORN

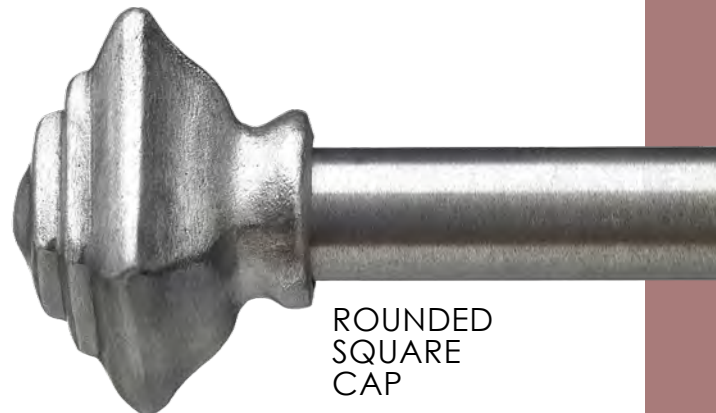

ROUNDED SQUARE CAP

BRACKETS

STANDARD

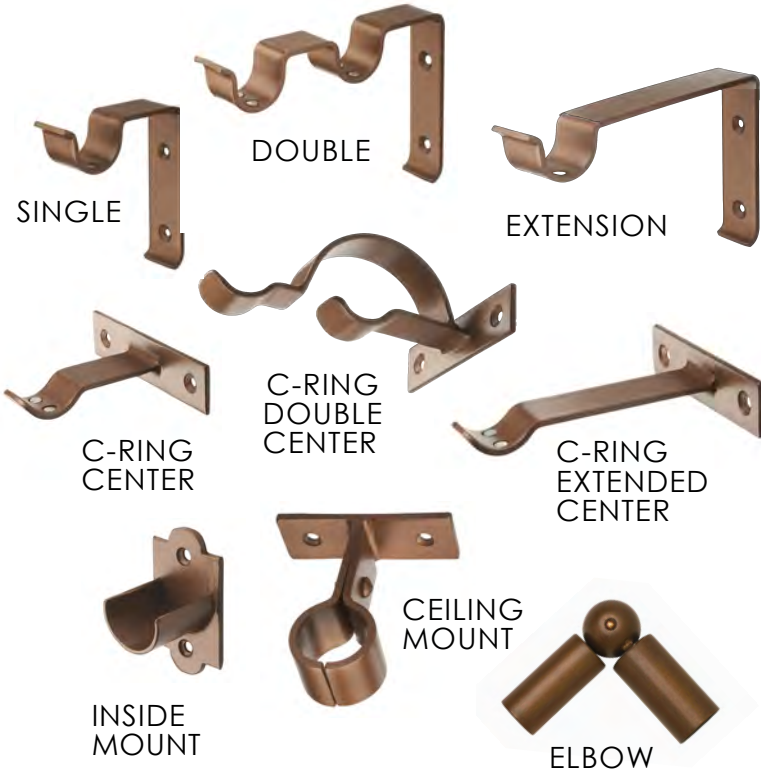

TRAVERSE

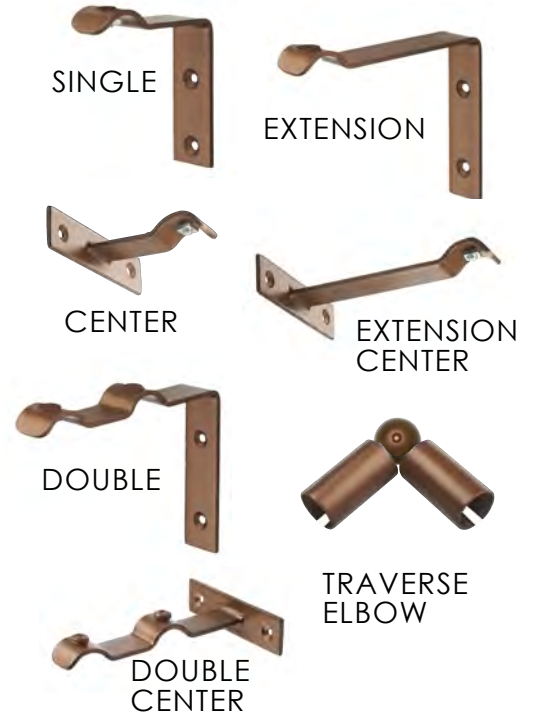

TIE BACKS



BRONZE
31

- 1" DIAMETER
- SINGLE AND DOUBLE ROD SETS
- FORGED IRON HARDWARE
- STANDARD AND TRAVERSE
- CUT TO SIZE
- BAY & CORNER WINDOWS
- INSIDE MOUNT



DOUBLE TRAVERSE



ONE-WAY DRAW

RUSTICA
14

ACCESSORIES

PEWTER
12

RINGS



1.5-INCH



C-RINGS



1.5-INCH

BLACK
03

BAYS & CORNERS

We can calculate your rod lengths for all your bay and corner windows!

PLEASE SEE THE MEASURING GUIDE

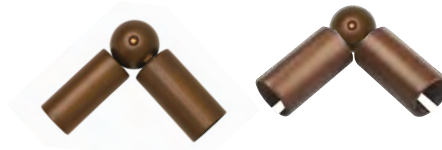

ADJUSTABLE ELBOWS

GOLD
37



OUTDOOR READY FINISH OPTION

Decorate your deck, cabana or outdoor space! Outdoor finish option is available for a 25% up-charge, which includes a full 5-year replacement warranty. Sets must be installed under an eave or overhang, avoiding direct exposure to the elements. Regular wipe down is required. Not recommended for high humidity or beach environments. AVAILABLE ONLY IN OIL RUBBED BRONZE, RUSTICA AND BLACK.

CUSTOM IRON

1" DIAMETER ROD SETS

SEE PRICELIST FOR PRICES AND ORDERING INFORMATION

Single Rod Set (1")

Double Rod Set (1" front rod and 1" back rod)

Single Traverse Rod Set (1-1/8")

Double Traverse Rod Set (1-1/8" front rod and 1-1/8" back rod)

Corner Window Rod Set (1") (1-1/8" Traverse)

Bay Window Rod Set (1") (1-1/8" Traverse)

Inside Mount Rod Set (1")

SET INCLUDES:

Rod, finials, brackets and mounting hardware.

- Single, Double, Corner and Bay Sets come with standard brackets included. Extension brackets can be substituted for no additional charge.
- Double rod sets feature end cap finials on the back rod.
- No finials on inside mount rod sets.
- Rod sets with overall widths greater than 72" include center bracket(s).
- Rod Sets up to 94" are made as one piece. Rod Sets over 94" and up to 188" will come in two pieces.
- Rod segments made in one piece over 94" carry a substantial shipping surcharge and production surcharge.

SPECIFICATIONS & DIMENSIONS

FINIALS

DESCRIPTION	DIMENSIONS	LENGTH ADDED TO ROD
Rounded Square Cap	2-1/4" W x 2-1/2" H	2"
Terrazzo	6" W x 2-3/4" H	5-3/4"
Torche	5-1/2" W x 2-3/4" H	5-1/4"
Capri	3-3/8" W x 2-1/2" H	3-1/4"
End Cap	1/2" W x 1-7/8" H	1/8"
Small Acanthus	4-1/2" W x 3" H	4-1/4"
Fleur	4-1/2" W x 3-1/8" H	4-1/4"
Acorn	3-3/8" W x 2" H	3-1/4"
Iron Ball	2-3/4" W x 2-1/2" H	2-5/8"

TIEBACKS

DESCRIPTION	DIMENSIONS
Flame (U style)	9" face x 2-1/4" w x 6-1/2" projection
Acanthus Leaf (U style)	7" face x 4" w x 5-1/4" projection
Scroll (U style) - left	7" face x 4" width x 4-3/4" projection
Scroll (U style) - right	7" face x 4" width x 4-3/4" projection
Orbed (U style)	6" face x 1-1/2" width x 6" projection
Iron Scroll (Post style)	7-1/2" face x 3-1/4" w x 4-3/4" projection
End Cap (Post style)	2" width x 4-3/8" projection
End Cap (U style)	6" face x 1-7/8" width x 5-3/4" projection

BRACKETS

DESCRIPTION	DIMENSIONS
Ceiling Mount Bracket	1" W x 3-1/8" H x 3" D (2-1/2" projection)
Forged Single Bracket	1" W x 4" H x 3-1/4" D (2-1/2" projection)
Forged Double Bracket	1" W x 4" H x 6" D (2-1/2" & 5" projection)
Forged Extension Bracket	1" W x 4" H x 6" D (5" projection)
C-Ring Center Bracket	4" W x 1" H x 3-1/8" D (2-1/2" projection)
C-Ring Double Center Bracket	4" W x 1" H x 5-3/4" D (2-1/2" & 5" projection)
C-Ring Extended Center Bracket	4" W x 1" H x 5-3/4" D (5" projection)
Inside Mount Bracket	1-1/4" W 2-1/4" H x 7/8" D (1/8" projection)
Single Traverse	1" W x 3" H x 3" D (2-1/2" projection)
Double Traverse	1" W x 4" H x 5-5/8" D (2-1/2" & 5" projection)
Extension Traverse	1" W x 4" H x 5-5/8" D (5" projection)
Center Traverse	4" W x 1" H x 3-1/8" D (2-1/2" projection)
Double Center Traverse	4" W x 1" H x 5-5/8" D (2-1/2" & 5" projection)
Extension Center Traverse	4" W x 1" H x 5-5/8" D (5" projection)

DESCRIPTION	INSIDE DIAMETER
Rings - eyelet (10 pack)	1 1/2"
C-Rings - eyelet (10 pack)	1 1/2"

* Projection is measured from the center of the bracket cup to the back plate of the bracket. D is the distance; it is measured from the front of the bracket to the back plate of the bracket. W is the horizontal length of the bracket while the H is the vertical length of the bracket back plate.





FRENCH RETURN



- 3/4" AND 1" DIAMETER
- SINGLE AND DOUBLE ROD SETS
- CUT TO SIZE

BRACKETS

END BRACKETS



CENTER BRACKETS

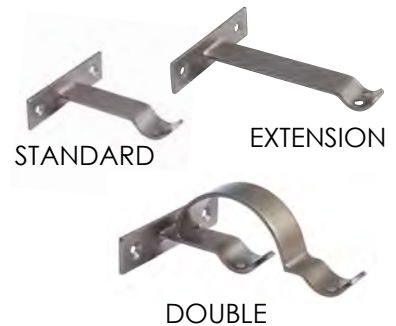

ACCESSORIES



1-1/2 & 1-1/4 INCH
INSIDE DIAMETERS



SPECIFICATIONS AND DIMENSIONS

DESCRIPTION

- 1" End Bracket
- 1" Center Bracket
- 1" Extension End Bracket
- 1" Extension Center Bracket
- 1" Double Center Bracket
- 3/4" End Bracket
- 3/4" Center Bracket
- 3/4" Extension End Bracket
- 3/4" Extension Center Bracket
- 3/4" Double Center Bracket

DIMENSIONS

- 2-1/2" W x 4-1/4" H x 4" D (3-1/2" projection)
- 4" W x 1" H x 4-1/4" D (3-1/2" projection)
- 2-1/2" W x 4-1/4" H x 5-1/2" D (5" projection)
- 4" W x 1" H x 5-5/8" D (5" projection)
- 4" W x 2" H x 5-3/4" D (2-1/2" & 5" projection)
- 3-1/4" W x 2" H x 3-7/8" D (3-1/2" projection)
- 4" W x 1" H x 4-1/8" D (3-1/2" projection)
- 2-1/2" W x 2" H x 5-3/8" D (5" projection)
- 4" W x 1" H x 5-1/2" D (5" projection)
- 4" W x 2" H x 5-1/2" D (2-1/2" & 5" projection)

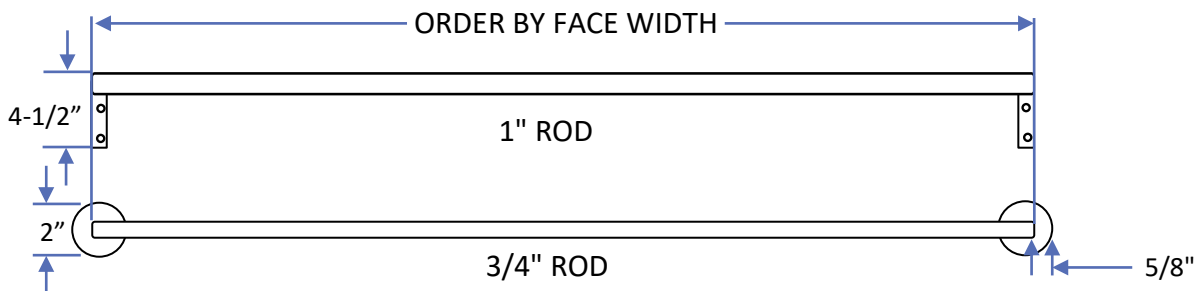

BLACK

GOLD

SMOKE

BRONZE

RUSTICA

IVORY





CONTEMPORARY METAL



BALL CAP



END CAP



BAROQUE



ORCHID



SAUSALITO



TRADITIONS

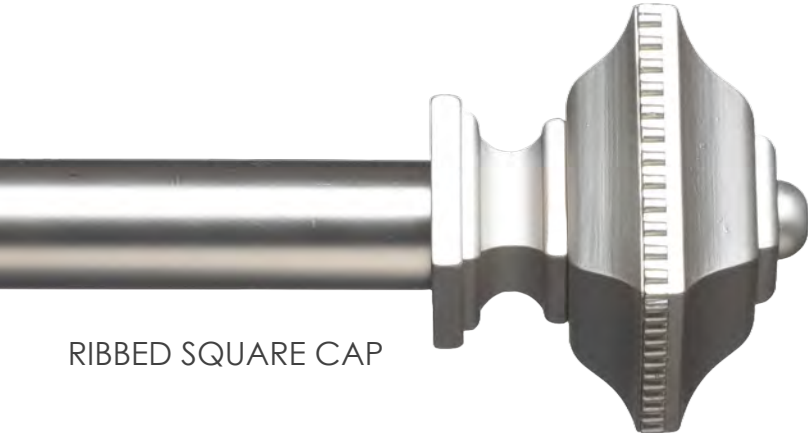

RIBBED SQUARE CAP

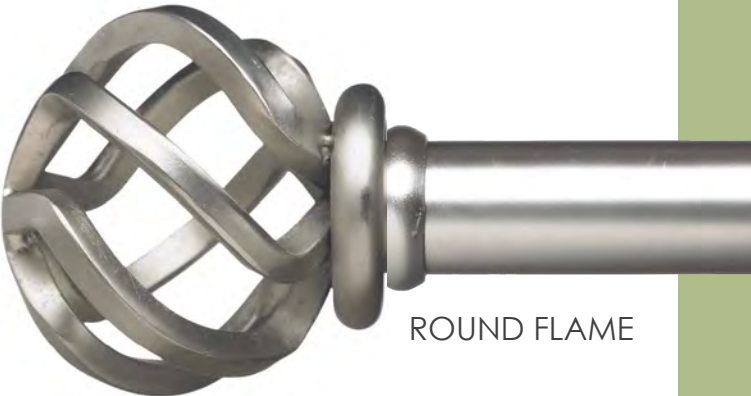

ROUND FLAME

BURNISHED
COPPER
15

COMPLETE SETS
AVAILABLE IN:

- 22" - 40"
- 40" - 76"
- 76" - 148"

- 1" ADJUSTABLE ROD SETS
- SINGLE AND DOUBLE ROD SETS
- CORNER AND BAY SETS
- INSIDE MOUNT

ACCESSORIES



CLIP RINGS



EYELET RINGS



POST TIEBACK

NICKEL
16

BLACK
03

BRACKETS

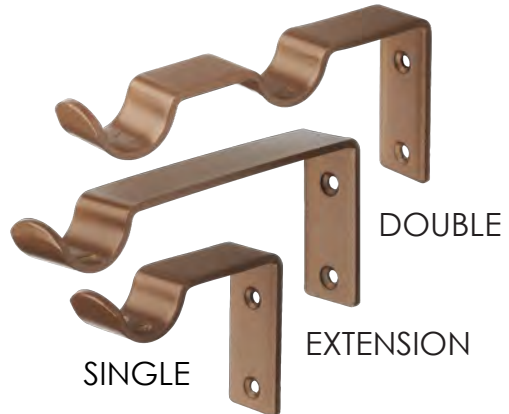

BAYS & CORNERS



ELBOW

BRONZE
31

SEE PRICELIST FOR PRICES AND ORDERING INFORMATION

CONTEMPORARY METAL

1" DIAMETER ROD SETS

SET INCLUDES: Rod, finials, brackets and mounting hardware.

- **Single Rod Set (1") ***
- **Double Rod Set (1" front rod and 1" back rod)**
- **Corner Window Rod Set**
- **Bay Window Rod Set (1")**
- **Inside Mount Rod Set (1")**

* with your choice of Standard or Extension Brackets

Double rod sets feature end cap finials on the 1" back rod.
No finials on inside mount rod sets.

SPECIFICATIONS & DIMENSIONS

FINIALS

DESCRIPTION	DIMENSIONS	LENGTH ADDED TO ROD
Ribbed Square Cap	2-7/8" W x 2-1/2" H	2-3/4"
Sausalito	2-1/2" W x 2-7/8" H	2-3/8"
Ballcap	2-3/4" W x 2-3/8"H	2-5/8"
Baroque	3" W x 2-1/8" H	2-7/8"
Orchid	3-5/8" W x 2-1/2" H	3-1/2"
End Cap	3/4" W x 1-3/8" H	5/8"
Traditions	3-3/4" W x 2-1/2" H	3-5/8"
Round Flame	2-3/4" W x 3" H	2-5/8"

RINGS

DESCRIPTION	INSIDE DIAMETER
Clip Rings (10 pack)	1-1/2"
Rings - eyelet (10 pack)	1-1/2"

BRACKETS

DESCRIPTION	DIMENSIONS
Single Bracket	1" W x 2-1/2" H x 3-1/4" D (2-1/2" projection)
Double Bracket (1)	1" W x 2-1/2" H x 5-3/4" D (2-1/2" & 5" projection)
Extension Bracket	1" W x 2-1/2" H x 5-5/8" D (5" projection)
Inside Mount Bracket	1-3/8" W 2-5/8" H x 1-1/2" D
Ceiling Mount Bracket	1" W x 3" H x 3" D (2-1/2" projection)
Elbow	Extends 3/4" from end of rod to center of swivel

(1) Front cup holds a 1" rod and back cup holds a 1" rod

* Projection is measured from the center of the bracket cup to the back plate of the bracket.
D is the distance; it is measured from the front of the bracket to the back plate of the bracket.
W is the horizontal length of the bracket while the H is the vertical length of the bracket back plate.

TIEBACK

DESCRIPTION	Post Tieback w/Finial Choice
DIMENSIONS	2" Diameter Base 4-1/4" depth plus finial dimension



SEDONA

RING OR TRAVERSE OPTIONS



HALO



CYLINDER



HUB CAP



END CAP



BUTTON



BOW TIE



SPHERE



NAKED

- 2" DIAMETER
- SINGLE AND DOUBLE ROD SETS
- STANDARD AND TRAVERSE OPTIONS
- RIPPLEFOLD CARRIERS AVAILABLE
- AMERICAN GROWN HARDWOOD
- CUT TO SIZE
- ROD SETS UP 182"



HIDDEN BRACKETS



DOUBLE ROD SET



WOOD AND METAL RINGS



POLISHED METAL
17



BLACK
03



RUSTICA
14



NICKEL
16



BRONZE
31



MAHOGANY
28



BLACK
41



DARK ROAST
29



PALLET WOOD
26



STORM
36



LEATHER
23



WHITE
20

SEE PRICE LIST FOR PRICES AND ORDERING INFORMATION

SEDONA

2" DIAMETER ROD SETS

SETS INCLUDE

Rod, finials, brackets and all hardware.

AVAILABLE CONFIGURATIONS

- Single Rod Set
- Double Rod Set
- Single Traverse Rod Set
- Double Traverse Rod Set

Rods are cut to the precise width ordered and end drilled for finials. Rod width greater than 72", include center support brackets. Rod Sets up to 94" are made as one piece. Rod Sets over 94" and up to 182" will come in two pieces. Rod segments made in one piece over 94" carry a substantial shipping and production surcharge. Specify "TR" for right draw and "TL" for left draw when ordering one way draw rod sets.

SPECIFICATIONS & DIMENSIONS

PART NAME	WIDTH	HEIGHT	DEPTH	LENGTH ADDED TO THE END OF THE ROD
-----------	-------	--------	-------	------------------------------------

FINIALS

Sphere	3-1/2"	3"	3"	3"
Halo	2"	3-1/2"	3-1/2"	1-5/8"
Hub Cap	1-1/4"	3"	3"	1"
Cylinder	2-1/2"	2"	2"	2-1/2"
End Cap	3/4"	2-3/4"	2-3/4"	1/4"
Button	3/4"	2-3/8"	2-3/8"	3/8"
Bow Tie	1-1/4"	2-7/8"	2-7/8"	1"
Naked	3/4"	2"	2"	3/4"

CEILING BRACKET

Custom made to any length 1-1/2" to 12"

PART NAME	WIDTH	HEIGHT	DEPTH	PROJECTION*
-----------	-------	--------	-------	-------------

BRACKETS

Single	2-7/8"	2"	3-1/4"	4-1/4"
Double	2-7/8"	2"	5-1/8"	2-1/2 AND 6-1/8"
Ceiling	2"	Custom	2"	
Extension	2-7/8"	2"	5-1/8"	6-1/8"

BRACKETS

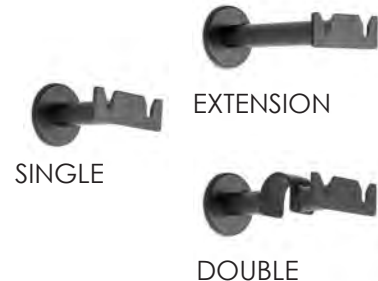

*Projection is measured from the wall to the center of the rod.

PART NAME	WIDTH	HEIGHT	DEPTH	PART NAME	INSIDE DIAMETER
-----------	-------	--------	-------	-----------	-----------------

TIEBACKS

Post & Button	2-3/8"	2-3/8"	4-1/4"	WOOD RINGS	2-5/8"
Wood Rosette	4"	4"	3-1/2"	METAL RINGS	2-1/2"



WOOD ROSETTE



POST & BUTTON





PLANTATION WOOD



WOOD BALL



TURNED KNOB



ASTORIA



DUCHESS 2" only



SULTAN 2" only



END CAP



DUKE 1-3/8" only

- 1-3/8" & 2" DIAMETERS
- STANDARD & TRAVERSE ROD SETS
- TRAVERSE AVAILABLE IN 2" ONLY
- AMERICAN GROWN HARDWOOD
- CUT TO SIZE



SPLIT-DRAW TRAVERSE

BRACKETS



SINGLE



DOUBLE



INSIDE MOUNT

ACCESSORIES



2-3/4 INCH



3-1/2 INCH



ROSETTE TIEBACK

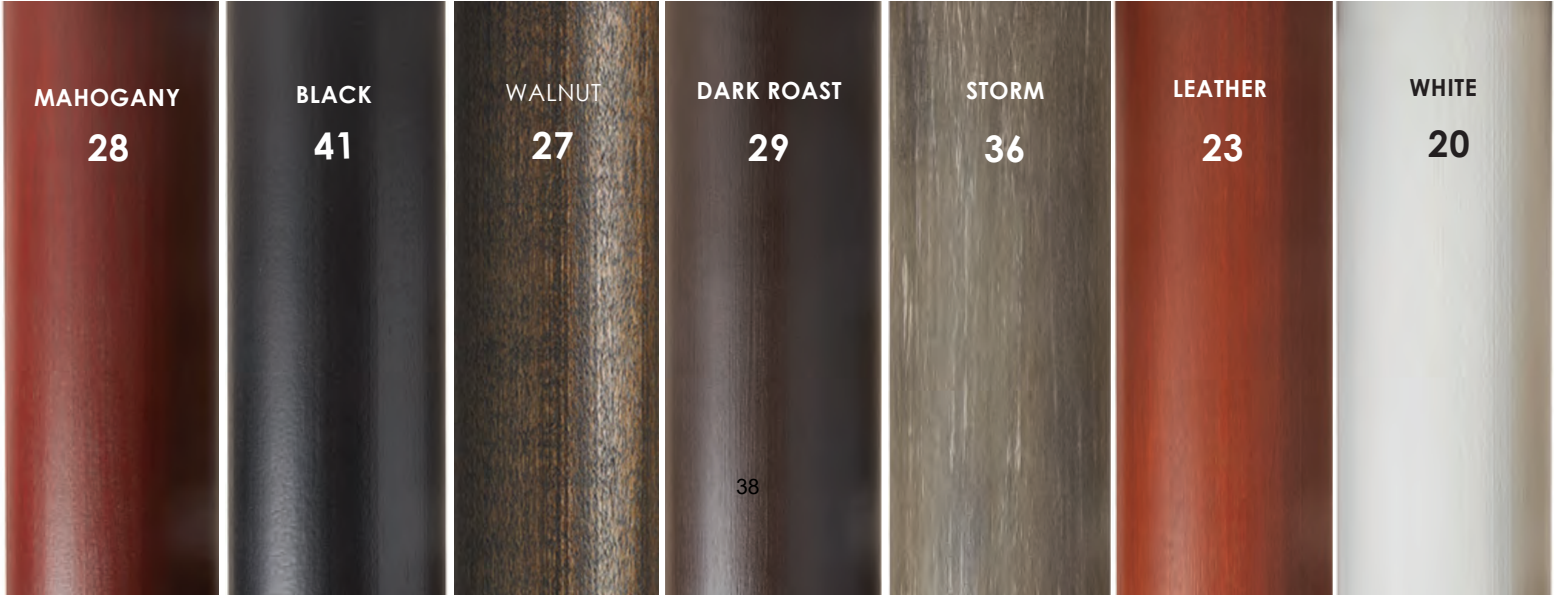

SEE PRICELIST FOR PRICES AND ORDERING INFORMATION

PLANTATION WOOD

1-3/8" and 2" DIAMETER ROD SETS

SETS INCLUDES: Rod, finials, brackets and mounting hardware.

1 3/8" DIAMETER

- Single Rod Set (1-3/8")
- Double Rod Set (1-3/8" front rod and 1-3/8" back rod)
- Inside Mount Rod Set (1-3/8")

2" DIAMETER

- Single Rod Set (2")
- Single Traverse Rod Set (2")
- Double Rod Set (2" front rod and 1-3/8" back rod)
- Inside Mount Rod Set (2")

FINIALS

DESCRIPTION	DIMENSIONS	LENGTH ADDED TO ROD
Wood Ball 3-1/4" W x 2-1/2" H	1-3/8"	3-1/8"
Turned Knob 3-1/4" W x 2-1/2" H	1-3/8"	3-1/8"
Astoria 3-1/8" W x 2-3/8" H	1-3/8"	3"
End Cap 1-1/8" W x 2" H	1-3/8"	1"
Duke 3-5/8" W x 3 H	1-3/8"	3-1/2"
Wood Ball 4-3/4" W x 3-1/2" H	2"	4-5/8"
Turned Knob 4-3/8" W x 3-1/2" H	2"	4-1/4"
Astoria 4-1/2" W x 3-3/8" H	2"	4-3/8"
End Cap 1-5/8" W x 3" H	2"	1-1/2"
Duchess 6" W x 3-1/2" H	2"	5-7/8"
Sultan 4-1/4" W x 4-1/2" H	2"	4-1/8"

Rods are cut to the precise width ordered and end drilled for finials. Double rod sets feature end cap finials on the 1-3/8" back rod. No finials on inside mount rod sets. Rod width greater than 72", include center support brackets. Rod Sets up to 94" are made as one piece. Rod Sets over 94" and up to 188" and traversing up to 168" will come in two pieces. Rod segments made in one piece over 94" carry a substantial shipping and production surcharge.

SPECIFICATIONS & DIMENSIONS

BRACKETS

DESCRIPTION	ROD SIZE	DIMENSIONS
Single Bracket	1-3/8"	1" W x 3-1/4" H x 5-1/4" D (3-7/8" projection)
Double Bracket (1)	1-3/8"	1" W x 3-1/4" H x 8-3/4" D (3-7/8" & 7-3/8" projection)
Inside Mount Bracket (*)	1-3/8"	1" W x 2-7/8" x 2-7/8" D
Single Bracket	2"	1-3/8" W x 4-1/4" H x 6-7/8" D (5" projection)
Double Bracket (2)	2"	1-3/8" W x 4-1/4" H x 9-1/2" D (4-1/4" & 7-3/4" proj.)
Inside Mount Bracket (*)	2"	1" W x 3-3/8" H x 3-3/8" D

- (1) Front cup holds a 1-3/8" rod and back cup holds a 1-3/8" rod.
- (2) Front cup holds a 2" rod and back cup holds a 1-3/8" rod.

Projection is measured from the center of the bracket cup to the back plate of the bracket.

D is the distance; it is measured from the front of the bracket to the back plate of the bracket.

W is the horizontal length of the bracket.

H is the vertical length of the bracket back plate.

*Subtract 1" total from inside dimension for rod length.

TIEBACKS

DESCRIPTION	Rosette
DIMENSIONS	4" face x 1" width x 4-3/8" deep

RINGS

DESCRIPTION	ROD SIZE	INSIDE RING DIAMETER
930 Wood Rings - eyelet (10 pack)	1-3/8"	1-3/4"
930-2 Wood Rings - eyelet (10 pack)	2"	2-1/2"



STRUCTURE

TRAVERSE OR MOTORIZED OPTIONS



BUTTON



SPHERE



CONTEMPO



KNOB



BOW TIE



END CAP



WAFFLE



NAKED

- 2" SQUARE RODS
- TRAVERSE & MOTORIZED
- SINGLE & DOUBLE ROD SETS
- CENTER & ONE-WAY DRAW
- STANDARD & RIPPLEFOLD CARRIERS
- AMERICAN GROWN HARDWOOD
- ROD SETS UP TO 182"
- CUT TO SIZE

TRAVERSE



DOUBLE TRAVERSE



SINGLE TRAVERSE

MOTORIZED



SINGLE MOTORIZED
(shown without motor)



DOUBLE MOTORIZED

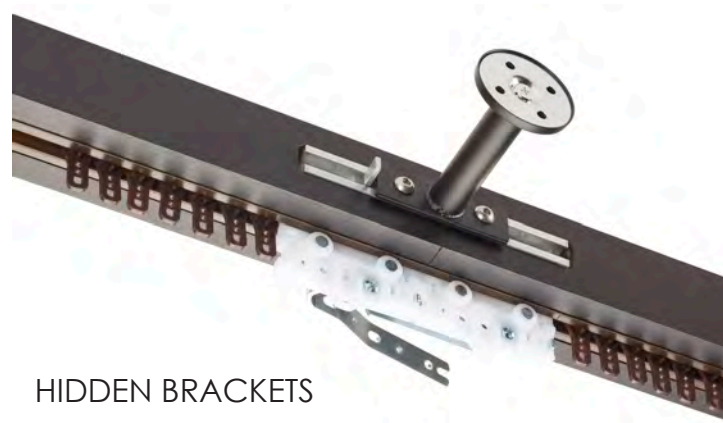

HIDDEN BRACKETS

SEE PRICE LIST FOR PRICES AND ORDERING INFORMATION

STRUCTURE

2" SQUARE ROD SETS

SETS INCLUDE

Rod, finials, brackets and all hardware.

AVAILABLE CONFIGURATIONS

- Single Motorized Rod Set
- Double Motorized Rod Set
- Single Traverse Rod Set
- Double Traverse Rod Set

TRAVERSE ROD SETS

Rods are cut to the precise width ordered and end drilled for finials. Rod width greater than 60", include center support brackets. Rod Sets up to 94" are made as one piece. Rod Sets over 94" and up to 182" will come in two pieces. Rod segments made in one piece over 94" carry a substantial shipping and production surcharge. Specify "TR" for right draw and "TL" for left draw when ordering one way draw rod sets.

MOTORIZED ROD SETS

Fascia wood cover is cut to the precise width ordered and ends drilled for finials. Rod Sets up to 94" are made as one piece. Rod Sets over 94" and up to 182" will come in two pieces. Rod segments made in one piece over 94" carry a substantial shipping and production surcharge. See "LOFT" Ordering Guide for more details.

SPECIFICATIONS & DIMENSIONS

PART NAME	WIDTH	HEIGHT	DEPTH	LENGTH ADDED TO THE OF THE ROD
-----------	-------	--------	-------	--------------------------------

FINIALS

Sphere	3-1/4"	3"	3"	3-1/4"
Naked	3/4"	2"	2"	3/4"
Waffle	3/8"	2-1/4"	2-1/4"	3/8"
Contempo	1-1/4"	2"	2"	1-1/4"
End Cap	3/4"	2"	2"	3/4"
Button	3/8"	2"	2"	3/8"
Bow Tie	7/8"	2-7/8"	2-7/8"	7/8"
Knob	5/8"	2-1/2"	2-1/2"	5/8"

PART NAME	WIDTH	HEIGHT	DEPTH	PROJECTION <i>(measured from wall to center of the rod)</i>
-----------	-------	--------	-------	---

BRACKETS

Single	2-7/8"	2"	3-1/4"	4-1/4"
Double	2-7/8"	2"	5-1/8"	2-1/2" AND 6-1/8"
Ceiling	2"	Custom	2"	
Extension	2-7/8"	2"	5-1/8"	6-1/8"

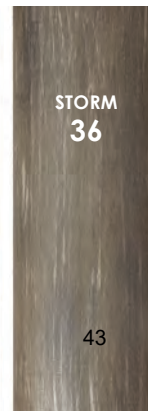





DRAPERY

MOTORIZATION

SIMPLIFIED.



Let's make it simple.

Professional quality motorization made simple. Tell us the size and type, we'll custom make it and deliver complete, ready to install with everything you need to get the job done.

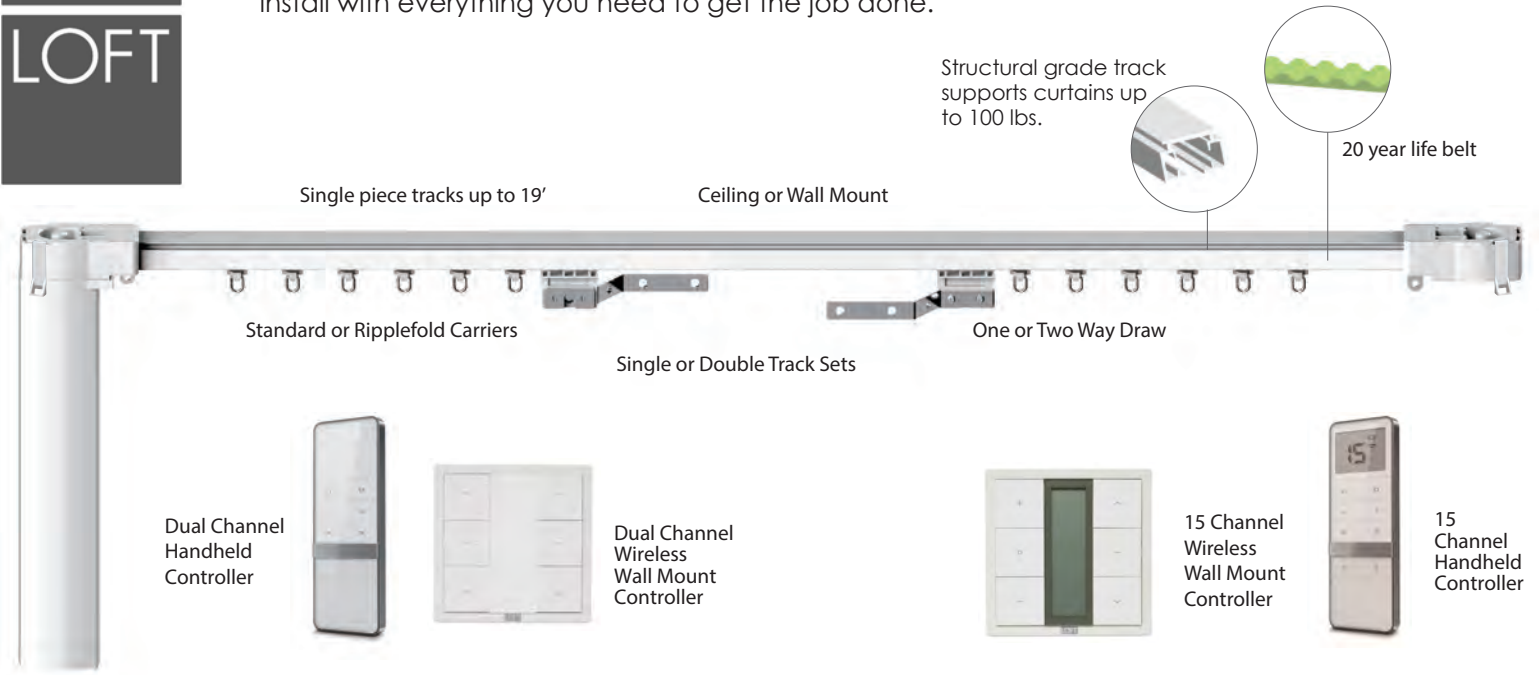

Powerful, yet quiet plug-in motor handles curtains up to 100 lbs. Motors are low voltage for added safety and can be mounted on the left or right.

Plug in or cordless motors available. Our Cordless Lithium-ion battery powered motor goes 6 months to a year on a single charge and is easily rechargeable with included charger.



RF Remote Control

Control a single or double rod set using our smart phone quality dual channel remote. Multi channel and wall mount controllers available. Wall controller detaches from magnetic base plate for portable use.



Whisper Quiet

Dampening technology reduces noise level below 30dB



Soft Opening & Closing

Smooth and elegant operation



Touch Start

Gently pulling the curtain will trigger the motor to open automatically



Automatic Limit Positions

Positions set automatically on the first use and re-calibrate everyday



Obstruction Protection

Motor will stop automatically if the curtain is pulled or it's path obstructed



Manual Operation

Curtains easily open and close manually in the event of power loss



Durability

Professional grade equipment built for years of worry free use. All components "best in class" quality and warranted for 5 years.



Decorative LOFT track cover
See STRUCTURE page





PRESENTATION SAMPLES



SAMPLE BAG

Our drapery hardware sample bag is an easy way to show your customer the style and unsurpassed quality of the product. The durable nylon sample bag is convenient for meetings and customer presentations.

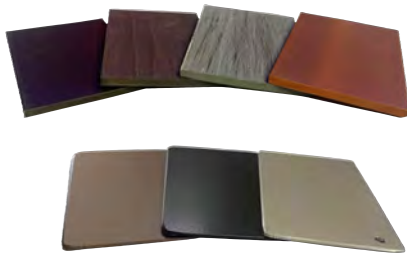

FINISH SAMPLES

BAG INCLUDES:

- Durable Sample Tote
- STRUCTURE wood+metal Sample
- Custom Iron Bracket Sample
- Custom Iron (1") Sample
- Estate Iron (1 1/2") Sample
- 2 SEDONA wood+metal Samples
- Retail Price List
- Finish Sample Plates

33.5"



36"



CUSTOM WROUGHT IRON

STYLE MIX

SAMPLE BOARDS

Wall mount sample boards feature complete rod sets including finials and brackets as well as rings representing each available finish. Boards can be ordered for each collection or a style mix board showing an example from each collection. Boards are furniture quality with hand finished hardwood trim.



SEDONA



PLANTATION WOOD



SEDONA & STRUCTURE



NEXT GENERATION IRON



FRENCH RETURN



MIX-IT

MEASURING GUIDE

MEASURING TIPS:

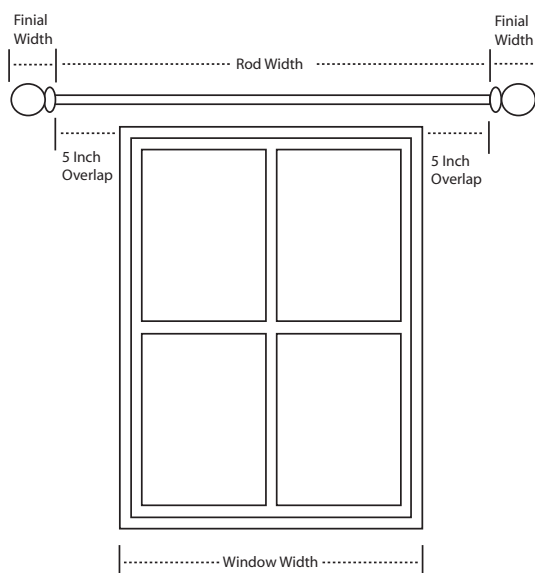

- Always use a steel tape measure. All dimensions should be taken to the nearest 1/4 inch.

- Double check to make sure that you haven't transposed width and height measurements.

- Measure every window. Windows that look identical often are not.

- If you have any questions, please contact Customer Service for more information.

BAY WINDOWS MEASURING:

Please answer the questions below.

To order a bay window rod set correctly, you need to provide the separate measurement of each section of the bay area wall (shown here as A, B and C) and the degree of each wall angle (shown here as Angle #1 and Angle #2).

If you would like us to determine the angles, you will need to additionally provide the opening width of the bay.



We will calculate your rod size based on these measurements and rod style you select. Our standard calculations allow for the finials to be just short of the outside of the opening. If you wish them to project out past the opening please advise when ordering.

DETERMINE YOUR HARDWARE WIDTH:

Rod width does not include the width of the finials on each end. Finials add 2" to 8" in width on each end, depending on the finial style. We recommend a 5" overlap on each side of the window.

For example if your window is 50" wide, you would normally order a 60" length rod and the overall finished width would be 64" to 76" depending upon the finial style.

INSIDE MOUNT MEASURING:

Have customer measure just the opening. Factory will need to know if you want deductions made for the inside mount brackets.

NEXT GENERATION IRON MOTORIZED

CARRIER COUNT GUIDE

NOTE: Exact carrier count is needed before we build your custom drapery rod. DO NOT count fixed carriers or pin holes on master carriers.

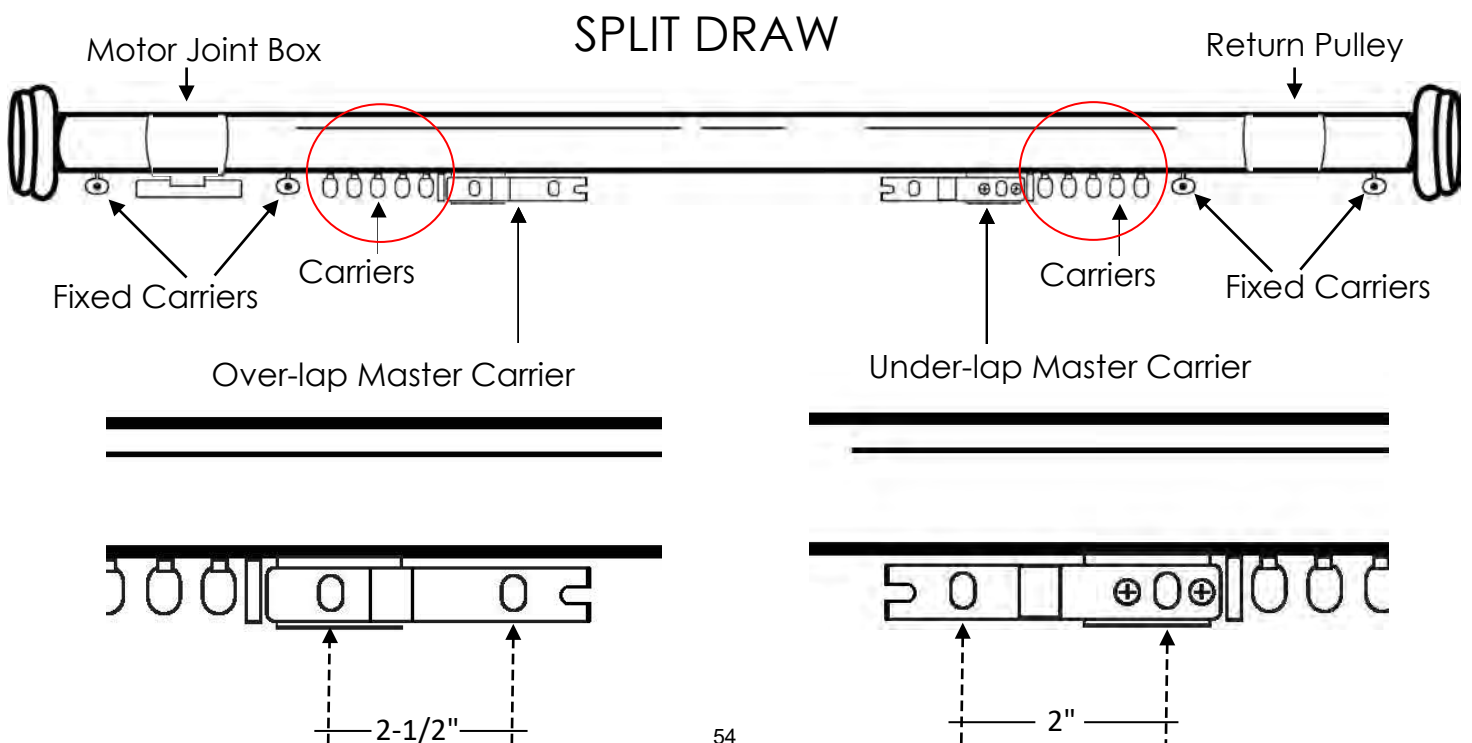
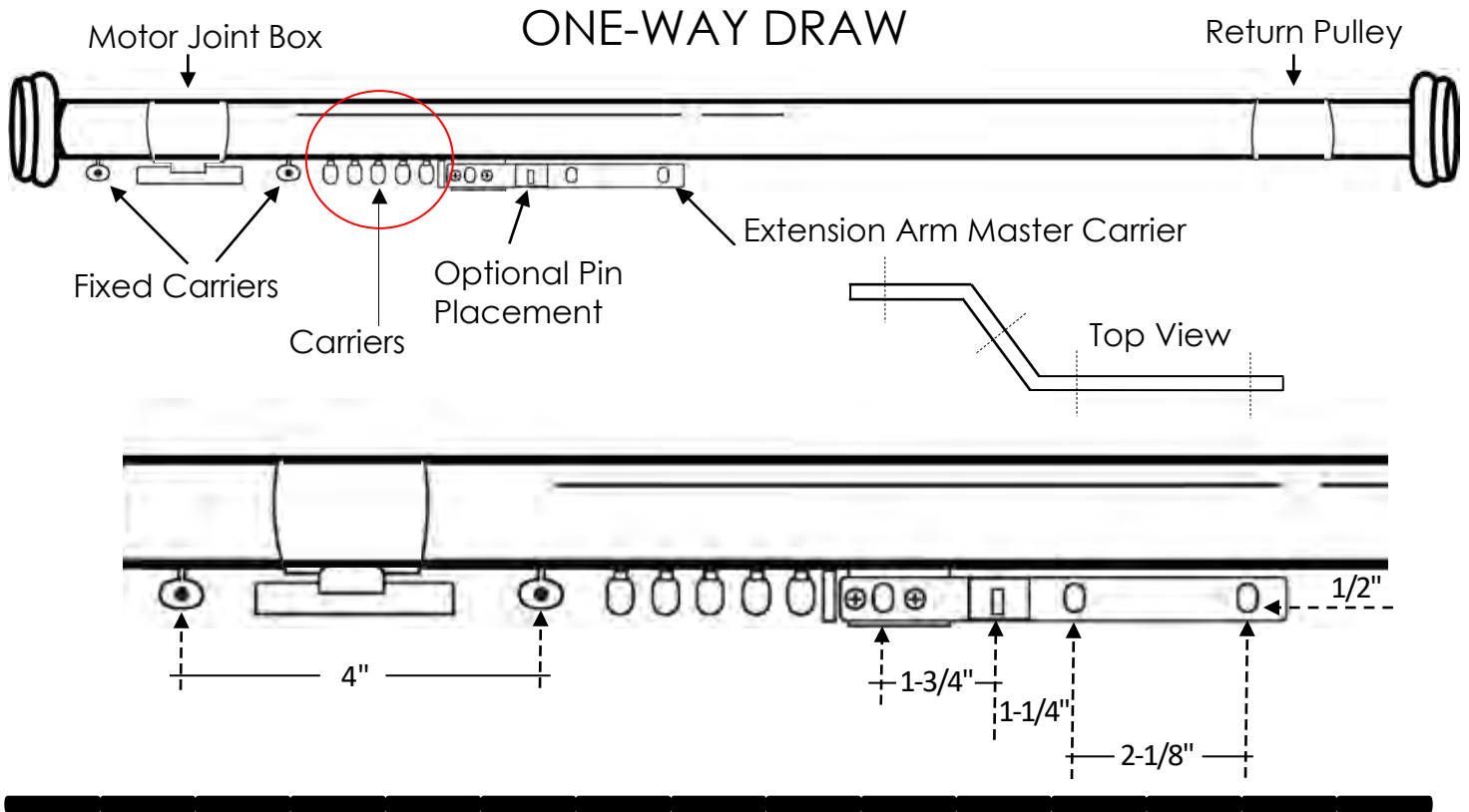



Ordering Guide

Follow the steps below to order each LOFT motorized track. We'll deliver assembled* and ready to mount. Easy to install, just mount the brackets, attach the track, snap in motor and hang the curtains.

Made a mistake? No worries, send it back and we'll fix it.

Sidemark: _____ Date: _____

Room: _____ Window: _____

Dealer: _____ PO# _____

Contact Phone: _____ Email: _____

Track Type *Tracks over 94" will be shipped in 2 pieces and require some assembly.

- Single motorized track Double, both tracks motorized

Track Length Example: Window opening is 50" wide and the curtains to be 12" past the window opening on both sides. Track should be 74" long.

- Over-all length _____

Choose Ripplefold Fullness:

- 60% 80% 100% 120%

Motor Position easy to switch in the field.

- Right or Left

Draw

- Two way/center opening
 One way/right draw One way/left draw

Mounting Brackets

- Wall (1.25" Clearance* / 2" Projection*) *Clearance = wall to back of track *Projection = wall to center of track
 Extended Wall (5.25" Clearance / 6" Projection)
 Ceiling

Carriers

- Standard Ripplefold

Master Carriers

- Standard overlap (4") Butt – Available on ripple fold and only on split draw

Motor Power Source

- Battery See price list for cost. Last 6 months to a year on a single charge. Includes recharging cord.
 110v plug-in (12' cord)

Remote Dual channel controls both single and double track sets. Remotes are paired with your motors at the factory and come ready to use.

- Dual channel handheld Dual channel wireless wall mount
 15 channel handheld 15 channel wireless wall mount

15 channel remotes are programmable, work on up to 30 sets.

Notes

